

Variable Area Flow Meters

Inline Liquid Flow Meter



CONTENTS

Introduction	3
Product Unpacking and Inspection	3
Operating Principle	4
Installation	5
Installing the Flow Meter	6
Installing the Test Kit Flow Meter	7
Operation	7
Test Kit Information	7
Test Procedures for Test Kit Flow Meters	8
General Information	8
Standard Test Conditions	8
Pump Test	8
Tee Test	9
Relief Valves	9
Maintenance	10
Removal of Dust Guard	10
Quick Re-Coupling	10
Test Kit Maintenance	11
Application Information	11
Density Effect (Specific Gravity)	11
Viscosity Effect (SUS/cSt)	12
Flow vs Pressure Drop	13
Specifications	17
Materials of Construction	17
Dimensions	19
Standard Meter	19
High Temp Meter	20
Test Kit	20

INTRODUCTION

The Inline Liquid Flow Meter is a rugged industrial class inline flow rate indicator, offered in aluminum, brass or stainless steel models to monitor a wide variety of liquids. Available in seven port sizes from 1/4... 3 inches for flow ranges from 0.02...0.20 gpm (0.1...0.75 lpm) through 20...300 gpm (100...1100 lpm), the meters are calibrated at 0.876 specific gravity for oil or other petroleum-based fluids, 1.0 for water or other water-based fluids, or 1.18 for phosphate ester liquids.

The flow meter is equipped with a 360° rotatable guard/scale which allows the meter to be installed in any orientation without regard to scale direction. Once the meter is permanently installed, the guard/scale can be rotated 360° to optimize readability.

In addition, the unique spring-loaded design of this variable area flow meter decreases viscosity sensitivity and allows it to be installed in any position, including inverted, without affecting accuracy. An optional inverted scale is available for these applications.

The standard flow meter is a unidirectional device. If required, a reverse flow bypass option is available for the oil, phosphate ester and water-based fluid models. Note that flow is measured in the forward direction only.

- **Aluminum** models are offered as a rugged, low cost flow meter for monitoring noncorrosive water-based or petroleum-based fluids under operating pressures up to 3500 psi (241 bar).
- **Brass** meters are recommended for water monitoring applications or other systems where corrosion inhibitors are not present.
- **Stainless Steel** is available for monitoring hydraulic systems operating at pressures up to 6000 psi (414 bar) or other corrosive caustic fluids, such as acetic acid. For further construction material information, see *"Materials of Construction"* on page 17.

PRODUCT UNPACKING AND INSPECTION

Upon receipt of the product, perform the following unpacking and inspection process:

If the product package is damaged, request the carrier to be present when unpacking the product. If the product is damaged and the carrier is not present, request an inspection by the carrier's agent within 48 hours of delivery and file a claim with the carrier. A claim for equipment damage in transit is the sole responsibility of the purchaser.

Carefully open the shipping package and follow any instructions marked on the exterior. Remove all packing material and carefully remove the product from the package.

Retain an undamaged package and all packing material for possible use in reshipment or storage.

Visually inspect the product and applicable accessories for any physical damage such as scratches, loose or broken parts, or any other sign of damage that may have occurred during shipment.

OPERATING PRINCIPLE

The flow meter is a variable area instrument. A sharp-edged orifice^①, located within the piston assembly^②, forms an annular opening with the contoured metering cone^③. The piston assembly carries a cylindrical PPS/ceramic magnet^④ that is magnetically coupled to an external indicating magnet^⑤ which moves precisely in direct response to movement of the piston. A calibrated spring^⑥ opposes flow in the forward direction.

The Hedland variable area flow meters are the most readable products in their class. Brightly colored indicators move over the graduated, linear flow scale^⑦ which contains bold, easy to read numeral and gauge marks. The enhanced resolution virtually eliminates parallax problems associated with competitive, direct reading flow meters.

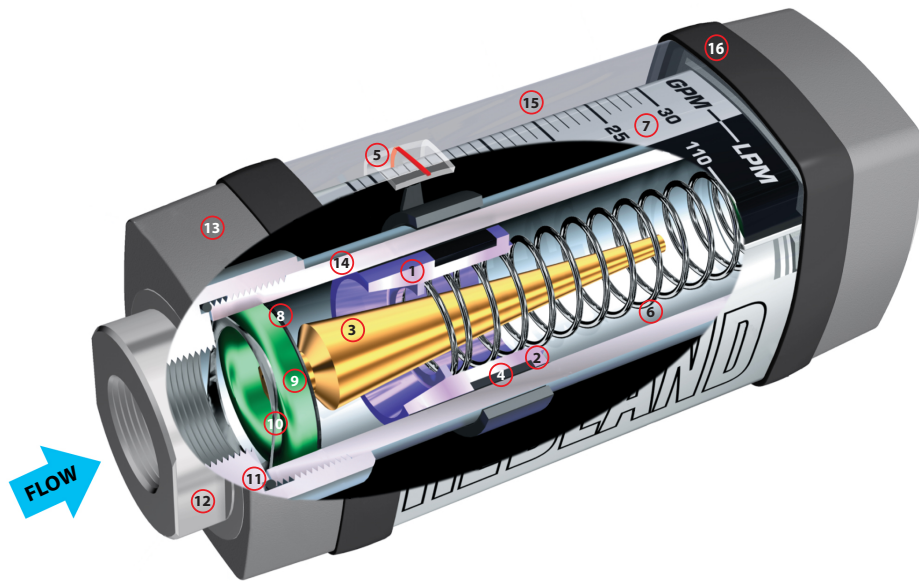

1	Orifice	9	Spider plate
2	Piston assembly	10	Retaining spring
3	Metering cone	11	Pressure seal
4	Internal magnet	12	End fitting
5	Flow indicator	13	End cap
6	Spring	14	Body
7	Flow scale	15	Guard
8	Retaining ring	16	Guard seal/bumper

Table 1: Meter components

INSTALLATION

⚠ CAUTION

THIS PRODUCT SHOULD BE INSTALLED AND SERVICED BY TECHNICALLY QUALIFIED PERSONNEL TRAINED IN MAINTAINING INDUSTRIAL CLASS FLOW INSTRUMENTATION AND PROCESSING EQUIPMENT.

⚠ CAUTION

READ INSTRUCTIONS THOROUGHLY BEFORE INSTALLING THE UNIT. IF YOU HAVE ANY QUESTIONS REGARDING PRODUCT INSTALLATION OR MAINTENANCE, CALL YOUR LOCAL SUPPLIER FOR MORE INFORMATION.

⚠ CAUTION

OIL METERS ARE NOT RECOMMENDED FOR WATER MONITORING APPLICATIONS. IF METER IS TO BE SUBJECTED TO BOTH OIL AND WATER, BRASS WATER METERS ARE SUGGESTED. CONSULT FACTORY FOR DETAILS.

⚠ CAUTION

THIS METER MAY CONTAIN RESIDUAL AMOUNTS OF TEST FLUID AT THE TIME OF SHIPMENT. THIS FLUID SHOULD BE REMOVED PRIOR TO INSTALLATION AS THE FLUID MAY BE INCOMPATIBLE OR HAZARDOUS WITH SOME LIQUIDS OR GASES. FAILURE TO FOLLOW THESE INSTRUCTIONS COULD RESULT IN DAMAGE TO THE EQUIPMENT.

⚠ CAUTION

THIS STANDARD METER IS UNIDIRECTIONAL. ATTEMPTS TO FLOW FLUIDS IN THE OPPOSITE DIRECTION OF THE FLOW ARROW WILL RESULT IN THE METER ACTING AS A CHECK VALVE, CREATING A DEADHEADING SITUATION. IF THE DIFFERENTIAL PRESSURE MAGNITUDE IS GREAT ENOUGH, DAMAGE TO THE INTERNAL PARTS OF THE METER WILL RESULT.

The inline flow meter is a simple device to install. However, the following measures are recommended for reliable, trouble-free operation:

- Align pipe accurately. Piping should be accurately aligned and of correct length. The high pressure body of the flow meter can withstand shock and flow/pressure pulsation. However, the piping should be firmly supported by external mounting brackets, both upstream and downstream of the meter, to avoid any pipe flexing actions that could reduce meter life.
- Use rigid mounting. If the flow meter inlet or outlet are to be rigidly mounted, and the opposing port is to be connected to flexible hose, the opposite end of the flexible hose must be rigidly mounted.
- Use Teflon® tape for sealing NPT fitting.
- Install unions. Install a union near the inlet or outlet of the meter. This will facilitate quick, easy meter removal and inspection during periodic maintenance procedures.
- Mount the meter either horizontally or vertically (flow arrow pointing to either side or straight up). If the meter must be mounted inverted, special inverted scales are available from the factory.
- Ensure the fluid is traveling in the direction of the flow arrow (*Figure 1*).
- Use at least a 200 mesh (74 micron) filter. The meter will allow particulate to pass that would jam most valves and flow controls. Systems that do not have filtration should be equipped with at least a 200 mesh (74 micron) filter. Most hydraulic systems already have much finer filtration.
- Dirt, ferrous metal or sealing agents, such as Teflon tape may lodge and cause malfunction. If the meter is jammed at a fixed position, follow cleaning and maintenance instructions.
- **Do not** use thread locking compounds as thread sealant.

- **Do not** install the flow meter near turbulence producing fittings such as elbows, reducers, close coupled valves, etc. The inline flow meter does not require flow straighteners or special lengths of straight inlet/outlet piping to stabilize turbulent flow patterns. However, to assure maximum operational reliability, avoid installation of elbows, valves and/or reducers immediately adjacent to the meter inlet.
- **Do not** install the meter near fast-acting valves. Fast-acting valves have the potential to create high magnitude hydraulic pressure spikes. These spikes can damage the internal components of the meter, resulting in inaccuracies or malfunction.
- **Do not** allow unidirectional meters to be operated against the direction of the flow arrow. The standard flow meter is a unidirectional flow meter. The piston acts as a check valve to block flow in the reverse direction. This causes an excessive pressure differential, which can result in damage to internal meter components. The flow meter is also available in a modified design, which offers a reverse flow bypass feature to accommodate bidirectional flow.

NOTE: Inline meters with a reverse flow bypass feature are available. Consult the factory for details.

Installing the Flow Meter

1. Mount the meter so fluid is traveling in the direction of the flow arrow.

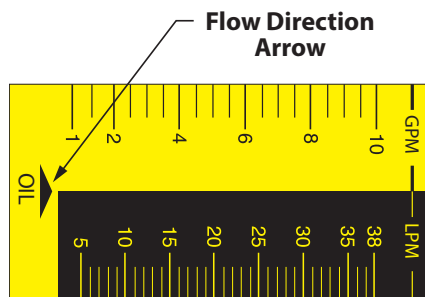
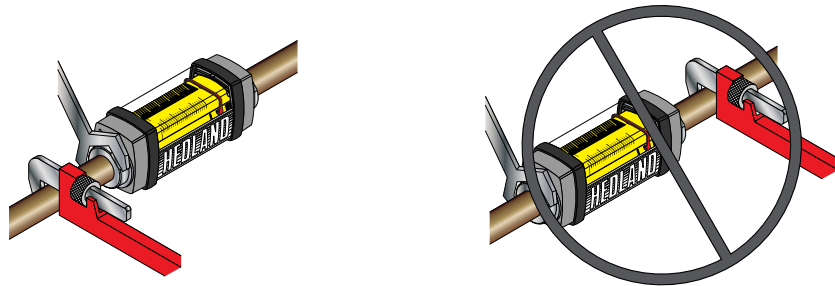

Figure 1: Flow direction arrow

2. Select a mounting location that is suitable for viewing and product service. To connect the flow meter into the piping system, place an open-ended wrench onto the flow meter wrench flats adjacent to the pipe connection being installed. **DO NOT** wrench on the opposite end of the flow meter or leakage may result.



Place wrench on meter flats on the same side plumbing is being tightened.

Never place wrench on meter flats opposite plumbing being tightened.

Figure 2: Installing the meter

3. After installation, rotate the meter by hand to view the flow scale.

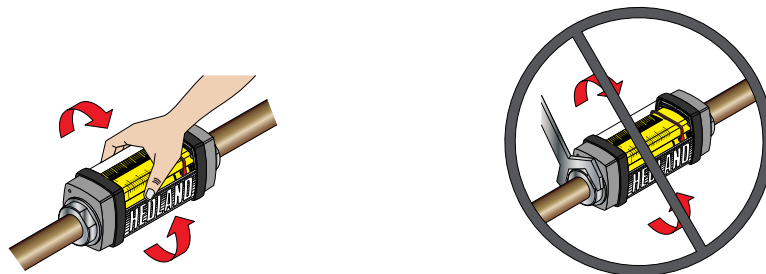

Rotate meter by hand to view flow scale

Never use wrench to rotate meter body when viewing flow scale

Figure 3: Rotating the meter

Installing the Test Kit Flow Meter

1. Mount the VA High Pressure Test Kit Flow Meter so fluid is traveling in the direction of the flow arrow. See *Figure 1*.
2. Install the test kit at any location in the hydraulic circuit that is suitable for viewing. To connect the test kit into the piping system, place an open-ended wrench onto the test kit valve on the inlet side or on the test kit wrench flat on the outlet side adjacent to the pipe connection being installed. **DO NOT** wrench on the opposite end of the test kit or leakage may result. See *Figure 4*.

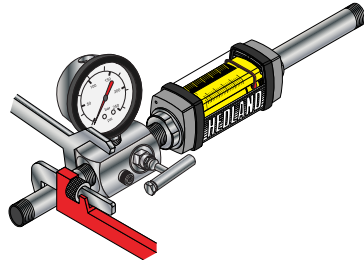

Place wrench on valve body **on the same side** plumbing is being tightened

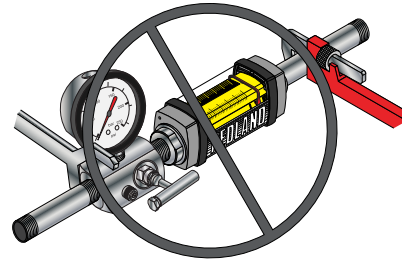

Never place wrench on valve body opposite plumbing being tightened

Figure 4: Installing the test kit

3. Or, use quick disconnect couplings for easy connections and to keep the test kit sealed and clean when not in use. For diagrams illustrating typical test placements for the test kits, see "*Test Procedures for Test Kit Flow Meters*" on page 8.
4. After installation, rotate the meter by hand to view the flow scale.

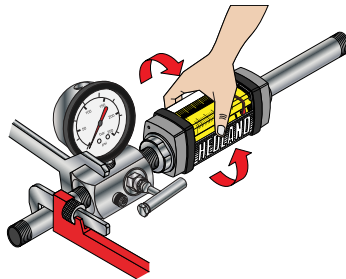

Rotate meter by hand to view flow scale

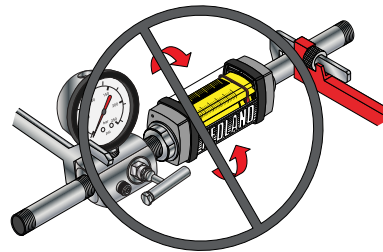

Never use wrench to rotate meter body when viewing flow scale

Figure 5: Rotating the test kit

OPERATION

See "*Application Information*" on page 11.

Test Kit Information

ALWAYS START WITH THE LOADING VALVE OPEN.

⚠ WARNING

ALL TEST KITS ARE SHIPPED WITH THE LOADING VALVE IN THE CLOSED POSITION. THE LOADING VALVE MUST BE OPENED FULLY BEFORE INITIATING FLOW AND TESTING OF THE HYDRAULIC CIRCUIT. TURN THE LOADING VALVE HANDLE COUNTERCLOCKWISE TO THE FULLY OPEN POSITION. FAILURE TO OPEN THE LOADING VALVE FULLY CAN RESULT IN INJURY TO PERSONNEL AND/OR DAMAGE TO THE EQUIPMENT.

TEST PROCEDURES FOR TEST KIT FLOW METERS

⚠ CAUTION

THE INFORMATION IN THIS MANUAL IS FOR GENERAL APPLICATION ONLY. ANY INFORMATION FURNISHED BY THE MANUFACTURER OF THE MACHINE'S HYDRAULIC COMPONENTS SHOULD BE FOLLOWED. SPECIFIC SYSTEMS MAY REQUIRE SPECIFIC TEST PROCEDURES.

General Information

The VA High Pressure Test Kits are designed to measure flow and pressure. Power measurements are derived from the product of flow and pressure. When using a test kit, power can be calculated using the following formulas:

$HP = \frac{GPM \times PSI}{1714}$	$HP = \frac{LPM \times bar}{447.4}$	$kW = \frac{LPM \times bar}{600}$
------------------------------------	-------------------------------------	-----------------------------------

Standard Test Conditions

1. Install the test kit as described in one of the following test procedures:
 - a. "Pump Test"
 - b. "Tee Test" on page 9
 - c. "Pump Test Using Tee Test Configuration" on page 9
 - d. "Relief Valve in Separate Housing" on page 9
 - e. "Relief Valves" on page 9
2. Open the loading valve fully by turning the handle counterclockwise.
3. Start the pump and adjust it to the rated speed.
4. Open the test kit loading valve fully and proceed with the required test procedure.
5. The test kit will indicate flow and pressure.

Pump Test

A tee must be installed between the pump discharge port and the return line to the tank. Be sure the fluid path is only through the pump, the hydraulic test unit and back to the tank. See *Figure 6*.

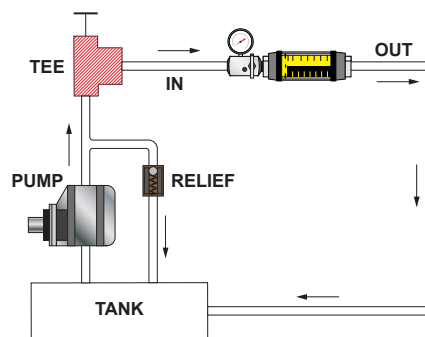

Figure 6: Pump test

1. Plug the line to the control valve.
2. Open the test kit loading valve fully to read maximum pump flow at zero pressure.
3. Close the loading valve to increase pressure from zero pressure to rated or maximum pump pressure to determine pump condition.
4. The pump flow at rated pressure can now be checked against the pump manufacturer's specifications. A decrease in flow from zero pressure to maximum pressure indicates the pump condition. A pump that delivers a constant low flow at zero pressure and at maximum pressure suggests suction problems.

Tee Test

A tee must be installed between the pump and control valve and connected to the inlet of the test kit. The outlet port of the test kit is connected to the tank. Pumps and relief valves can be isolated from the system and checked with the tee test. See *Figure 7*.

Pump Test Using Tee Test Configuration

1. Plug the line to the control valve.

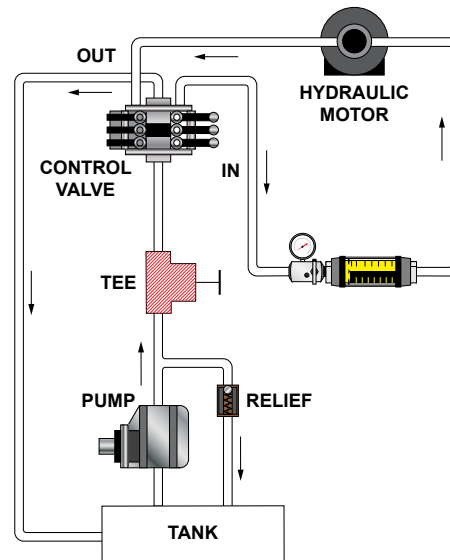

Figure 7: Tee test

2. Open the test kit loading valve fully to read maximum pump flow at zero pressure.
3. Close the loading valve to increase pressure from zero pressure to rated or maximum pump pressure to determine pump condition.
4. The pump flow at rated pressure can now be checked against the pump manufacturer's specifications. A decrease in flow from zero pressure to maximum pressure indicates the pump condition. A pump that delivers a constant low flow at zero pressure and at maximum pressure suggests suction problems.

Relief Valve Test

1. Put a control valve into a power output mode with the output flow blocked, such as a cylinder at the end of its stroke.
2. Close the test kit loading valve while viewing the pressure. Pressure will increase until the relief valve opens. Record the pressure at this point. Repeat to check the relief valve adjustment.

Relief Valve in Separate Housing

1. Plug any extra outlets.
2. Close the test kit loading valve and watch the pressure and flow.
3. Reconnect the control valve to the tee. Put a control valve into a power output mode with the output flow blocked, such as a cylinder at the end of its stroke.
4. Close the test kit loading valve while watching the pressure. Pressure will increase until the relief valve opens. Record the pressure at this point. Repeat to check the relief valve adjustment.

Relief Valves

Often relief valves will start to open before they reach their full pressure flow settings. This can be noted by comparing the pressure and flow rate readings made in step 4 in "Pump Test Using Tee Test Configuration". Any great decrease in flow rate from tests made in step 4 in "Pump Test Using Tee Test Configuration" indicates a faulty relief valve.

MAINTENANCE

⚠ WARNING

BEFORE ATTEMPTING TO REMOVE THE FLOW METER FROM THE LINE, CHECK THE SYSTEM TO CONFIRM THAT LINE PRESSURE HAS BEEN REDUCED TO ZERO PSI. FAILURE TO FOLLOW THESE INSTRUCTIONS COULD RESULT IN SERIOUS PERSONAL INJURY OR DEATH AND/OR DAMAGE TO THE EQUIPMENT.

1. Remove the flow meter from the line. Remove excess piping from meter.

NOTE: It is not necessary to remove the transparent dust guard from the meter to remove the meter from the line. If you choose to remove the dust guard assembly, see "Removal of Dust Guard" on page 10.

2. Thoroughly wipe off the entire flow meter surface using mild detergent or isopropyl alcohol.

⚠ CAUTION

DO NOT USE AROMATIC HYDROCARBONS, HALOGENATED HYDROCARBONS, KETONES OR ESTER BASED FLUIDS ON POLYCARBONATE LENS. FAILURE TO FOLLOW THESE INSTRUCTIONS COULD RESULT IN DAMAGE TO THE METER.

3. Remove the inlet cap from the flow meter, noting the sequence of disassembly for later reference (during reassembly).
4. The internal parts are secured with a retaining ring. Remove the retaining ring and the internal wetted parts from the flow meter.

NOTE: If internal parts do not slide freely from flow meter, use a wooden dowel inserted into the outlet port of the meter to push the parts out.

5. Place all parts on a clean work surface. Clean and inspect all parts. Replace any that appear worn or damaged. Check inlet port O-ring for damage and replace if required.

⚠ CAUTION

FIELD REPLACEMENT OF THE SPRING, METERING CONE AND/OR PISTON/MAGNET ASSEMBLY MAY RESULT IN CHANGES TO THE CALIBRATION OF THE FLOW METER.

6. Reassemble the spring, then the piston/magnet assembly and the retaining ring into flow meter.
7. Install the metering cone/spider plate assembly, retaining spring, and secure with the inlet cap.
8. Reinstall the meter to the line.

Removal of Dust Guard

To remove the dust guard for cleaning or replacement, simply loosen the end fitting located at the bottom of the meter and slide the end cap, dust bumper, and the dust guard off the bottom of the meter, taking care to avoid damaging the O-ring seal between the end cap and the dust gland.

Quick Re-Coupling

This piston-type variable area flow meter is inherently less sensitive to shock and vibration than other variable area designs. The unique magnetic coupling also eliminates the need for mechanical linkages that can wear or loosen over the functional life of the meter.

However, a pressure spike or extreme flow surge can cause the piston to move at such rapid speed that it disconnects the piston magnet and the external indicator ring. If this occurs, use one of these procedures to re-couple the magnet and the external indicator ring:

- If the system permits, simply change flow rate from "no flow" to "full flow" allowing the moving piston to magnetically re-couple to the indicator ring.
- For rigorous cyclical applications where de-coupling may occur frequently, consult the technical services staff for further recommendations.

Test Kit Maintenance

Load Valve

If the valve fails to load the system, remove the valve body and check for foreign material and worn parts or seals.

Flow

The absence of any flow reading may indicate a seized piston assembly. Remove any material that may be preventing the piston to slide.

If the test kit still fails to indicate flow, return the test kit to the factory.

APPLICATION INFORMATION

Density Effect (Specific Gravity)

Any fluid density change from stated standards has a proportional effect on meter accuracy. Special scales can be supplied if actual specific gravity decreases accuracy beyond application limits. Corrections for more or less dense fluids can be made to standard scales using the following correction factors:

$$\sqrt{\frac{1.0}{\text{Specific Gravity}}}$$
 for water/water-based meters

$$\sqrt{\frac{0.876}{\text{Specific Gravity}}}$$
 for petroleum-based meters

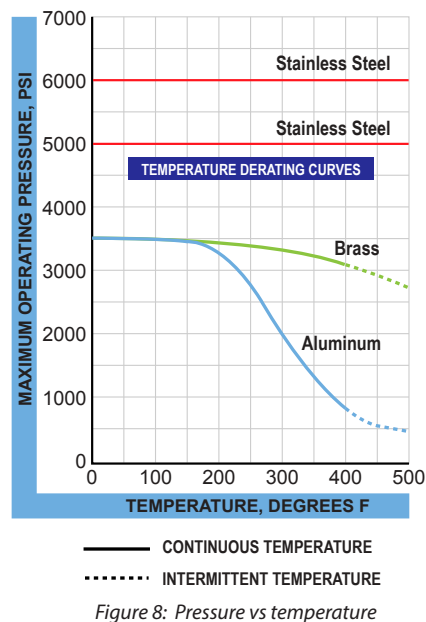

Viscosity Effect (SUS/cSt)

The design uses a precision machined, sharp-edged orifice and biasing calibration spring that assures operating stability and accuracy over the wide viscosity range common to many fluids. Generally, high flow models of each meter size provide good accuracy over a viscosity range of 40...500 SUS (4.2...109 cSt).

Fluid	Specific Gravity	Correction Factor		Aluminum	Brass	T16 SST	T303 SST	Viton®	EPR	Polycarbonate	Nylon	Pyrex®
		Oil	Water									
Acetic Acid (Air Free)	1.06	0.909	0.971	C	N	R	R	R	R	C	N	R
Acetone	0.79	1.053	1.125	R	R	R	R	N	R	N	R	R
Alcohol Butyl (Butanol)	0.83	1.027	1.098	C	C	R	R	C	R	R	R	R
Alcohol Ethyl (Ethanol)	0.83	1.027	1.098	C	C	R	R	C	R	R	N	R
Ammonia	0.89	0.992	1.060	R	C	R	R	N	R	N	C	R
Benzine	0.69	1.127	1.204	C	R	R	C	R	N	N	R	R
Carbon Disulphide	1.26	0.834	0.891	R	N	R	R	R	N	N	R	R
Castor Oil	0.97	0.950	1.015	C	R	R	C	R	N	C	C	R
Cotton Seed Oil	0.93	0.970	1.037	C	R	R	R	R	N	R	R	R
Ethylene Glycol 50/50	1.12	0.884	0.945	R	R	R	R	R	R	R	C	R
Freon II	1.46	0.774	0.828	R	R	R	R	R	N	R	R	R
Gasoline	0.70	1.119	1.195	R	R	R	R	R	N	C	R	R
Glycerin	1.26	0.834	0.891	R	R	R	R	R	R	R	C	R
Kerosene	0.82	1.033	1.104	R	R	R	R	R	N	R	R	R
Liquid Propane (LPG)	0.51	1.310	1.400	R	R	R	R	R	N	N	R	R
Mineral Oil	0.92	0.976	1.042	R	N	R	R	R	N	R	R	R
Naphtha	0.76	1.074	1.147	R	N	R	R	R	N	C	R	R
Perchloroethylene	1.62	0.735	0.786	C	N	R	R	R	N	N	N	R
Petroleum Oil	0.876	1.000	1.068	R	R	R	R	R	N	R	R	R
Phosphate Ester	1.18	0.862	0.921	R	R	R	R	N	R	N	R	R
Phosphate Ester Base	1.26	0.833	0.891	R	R	R	R	N	R	N	R	R
Phosphoric Acid (Air Free)	1.78	0.701	0.749	N	N	R	N	R	N	R	N	R
Sea Water	1.03	0.922	0.985	N	N	C	C	N	R	R	R	R
Synthetic Petroleum Base	1.00	0.936	1.000	R	C	R	R	R	N	R	R	R
Water	1.00	0.936	1.000	N	R	R	R	N	R	R	R	R
Water Glycol 50/50	1.07	0.905	0.967	R	R	R	R	R	N	R	R	R
Water-in-oil	0.93	0.970	1.037	R	R	R	R	N	R	R	R	R

R-Recommended
N-Not Recommended
C-Consult Factory

Table 2: Fluid selection chart

Flow vs Pressure Drop

1. The pressure drop curves are valid for fluids with density and viscosity similar to factory test fluids. Fluids, especially with higher viscosity than these test fluids, will yield a higher pressure drop through the flow meter and piping system per a given flow volume.
2. A system must have adequate fluidic horsepower available to move the system fluid at a prescribed rate at a pressure adequate to overcome all pressure reducing devices, including the flow meter.

Petroleum Fluids

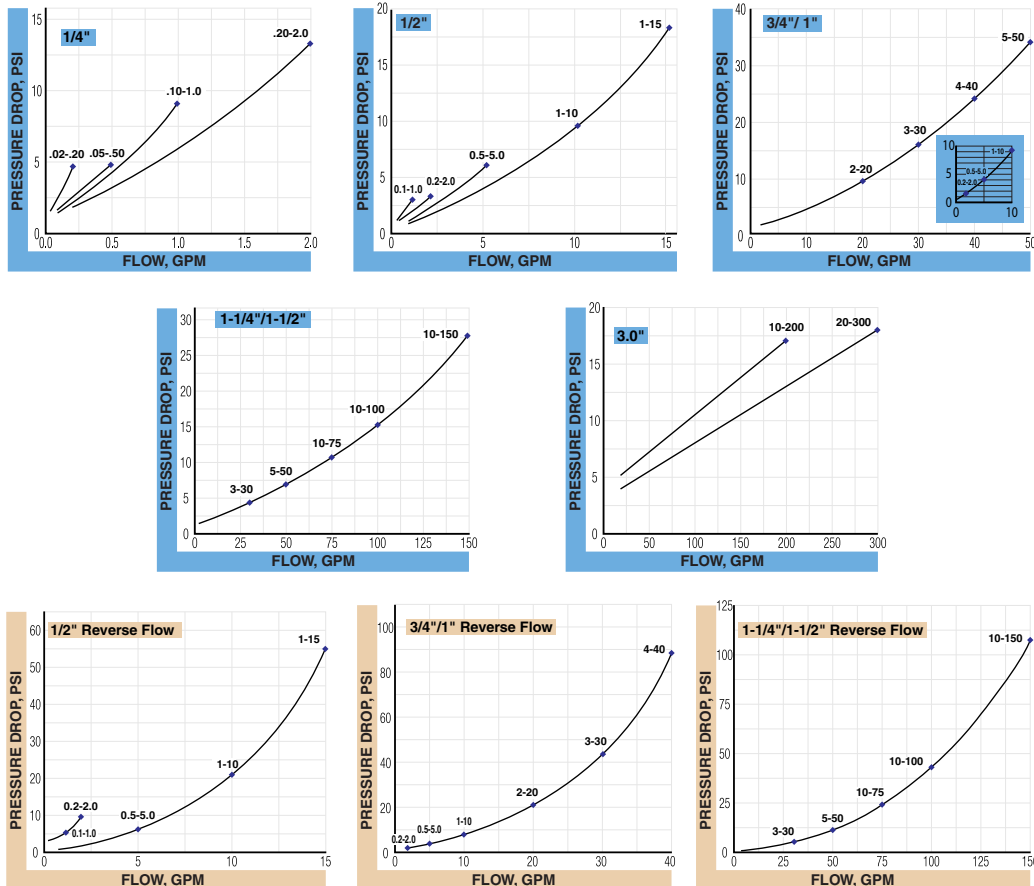

Petroleum Test Kits

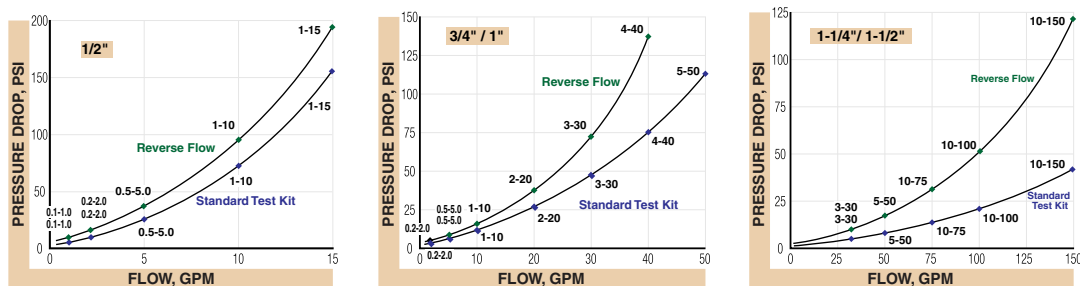

Phosphate Ester

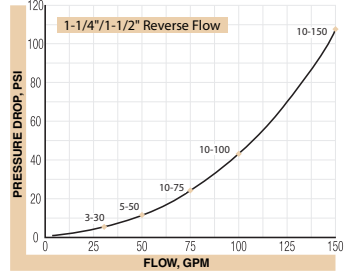
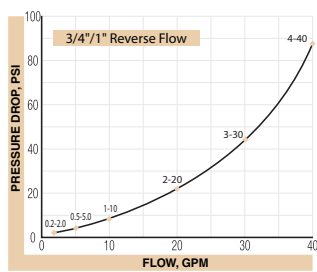
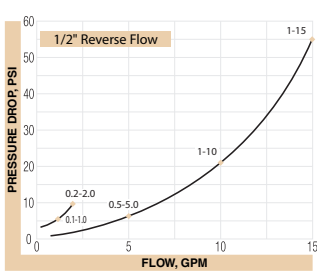
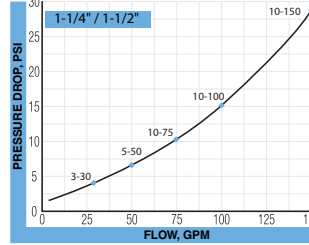
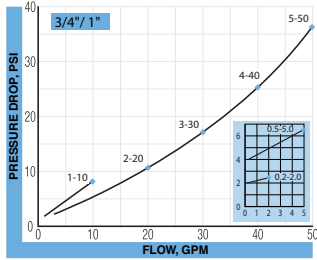
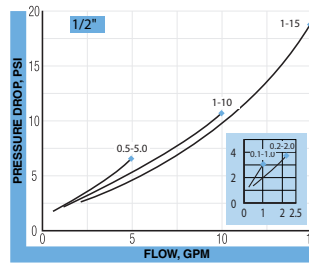
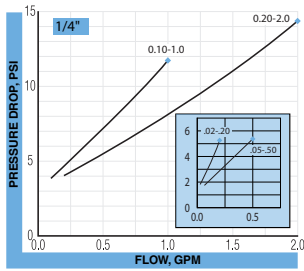

Phosphate Ester Test Kits

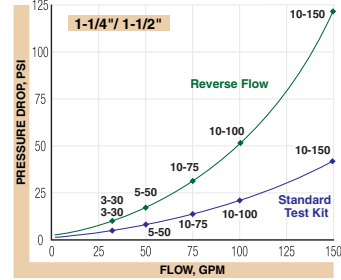
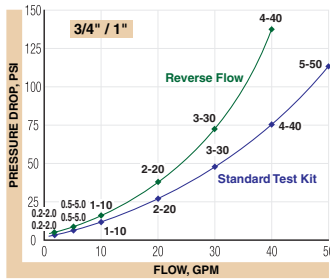
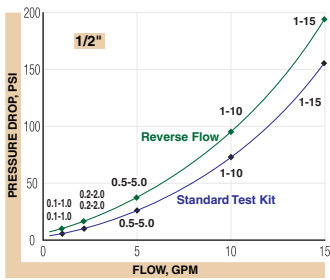

API Oil

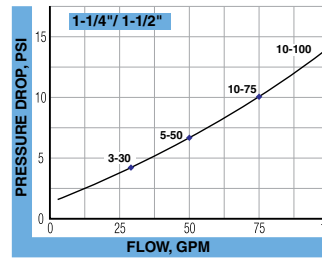
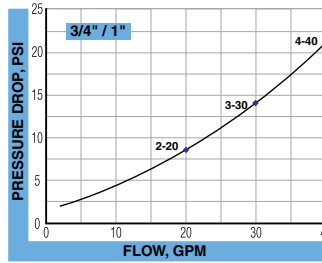
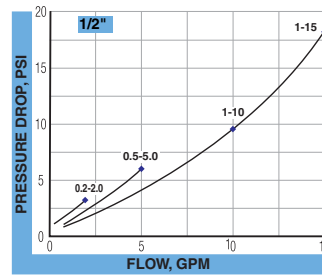
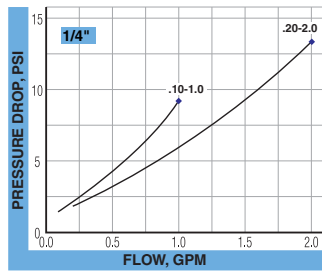

Water-Based Fluids

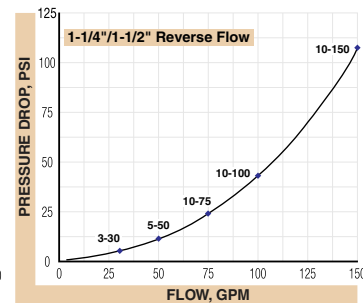
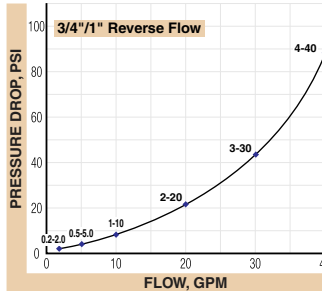
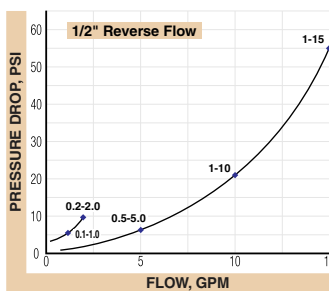
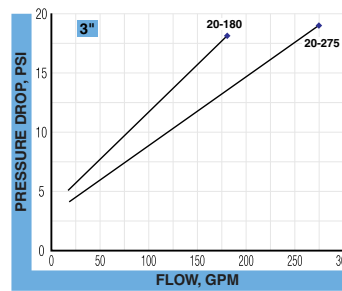
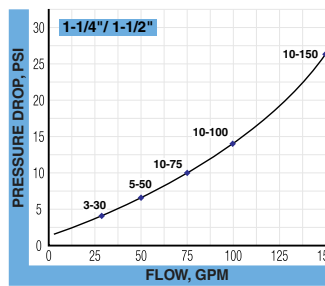
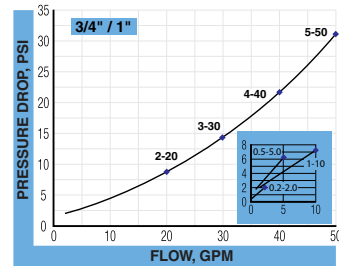
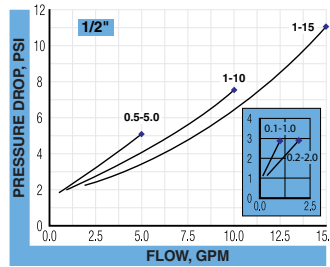
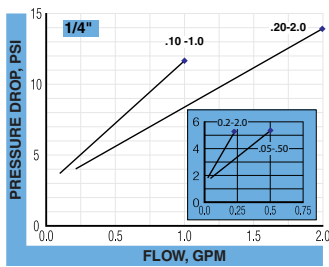

Water-Based Test Kits

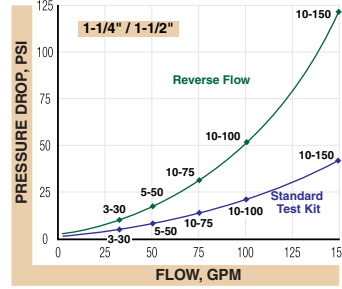
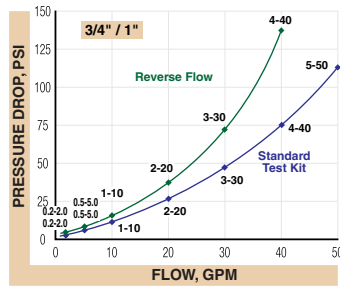
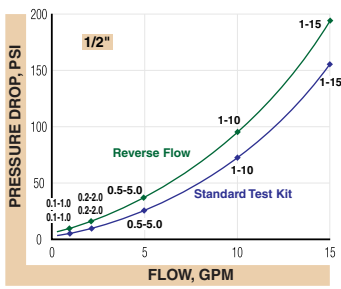

Water

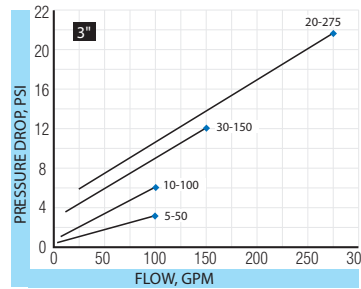
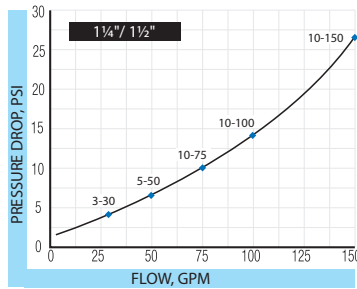
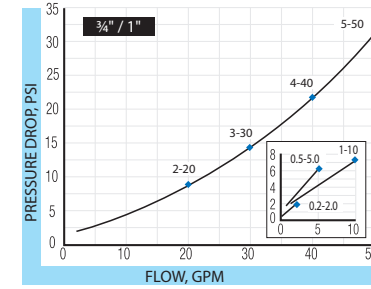
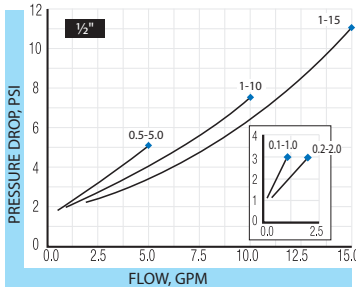
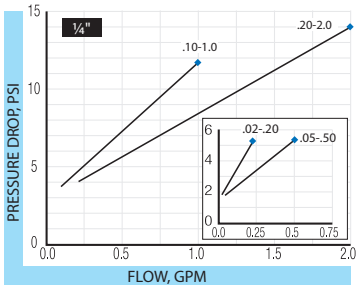

Caustic and Corrosive Liquids

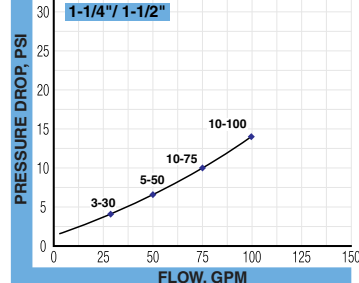
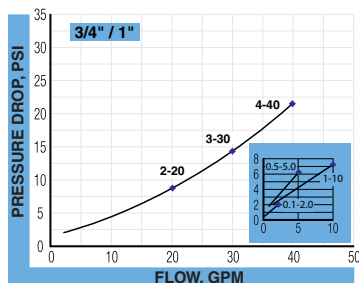
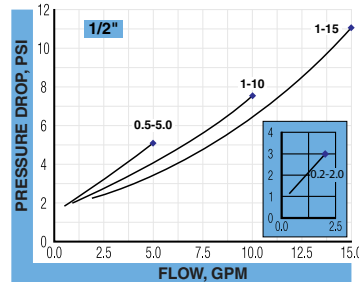
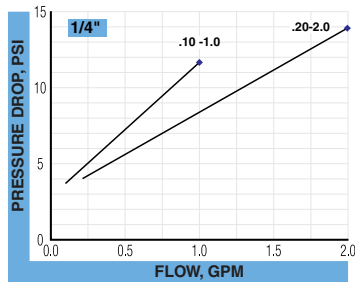

SPECIFICATIONS

Temperature Range	Standard	-20...240° F (-29...116° C)
	High temperature and hostile environment	-20...400° F (-29...205° C) continuous 400...500° F (205...260° C) intermittent
Pressure Rating (3:1 safety factor)	Aluminum/brass models	3500 psi (241 bar) maximum
	Stainless steel models	1/4 in. and 1/2 in. sizes 6000 psi (414 bar) maximum 3/4...1-1/2 in. sizes 5000 psi (345 bar) maximum
Pressure Drop	See "Flow vs Pressure Drop" on page 13 for specific meter information.	
Accuracy	±2% of full scale	
Repeatability	±1%	
Threads	SAE J1926/1, NPTF ANSI B2.2, BSPP ISO1179, Code 61 and Code 62: SAEJ518	
Test Kit Pressure Gauge, Glycerin Dampened	Aluminum/brass models	0...3500 psi (0...240 bar)
	Stainless steel models	0...6000 psi (0...400 bar)
Test Kit Load Valve	1/2 in., 3/4 in. and 1 in. sizes	Needle valve
	1-1/4 in. and 1-1/2 in. sizes	Ball valve
	Produce ΔP up to 3500 psi (241 bar) PSID and 6000 psi (414 bar) PSID	

Materials of Construction

Basic Flow Meters and Test Kits

Meter Model	Body	Piston	Cone	Spider Plate	Spring	Fasteners	Pressure Seals	Guard	Retaining Ring	Retaining Spring	Indicator & Internal Magnet	Guard Seal/Bumper	Scale Support	End Caps
Oil Basic & Test Kit	2024-T351 Anodized Aluminum		T316SS	T302SS	T303SS	Viton [*]	Polycarbonate	SAE 1070/1090 Carbon Steel	SAE 1070/1090 Carbon Steel	PPS/Ceramic	Buna N	6063-T6 Aluminum	Nylon ST	
	C360 Brass ¹													
	T303SS	2024-T351 Anodized Aluminum												
PE Basic & Test Kit	2024-T351 Anodized Aluminum		T316SS	T320SS	T303SS	EPR	Polycarbonate	SAE 1070/1090 Carbon Steel	SAE 1070/1090 Carbon Steel	PPS/Ceramic	EPR	6063-T6 Aluminum	Nylon ST	
	C360 Brass													
	T303SS	2024-T351 Anodized Aluminum												
WBF Basic & Test Kit	2024-T351 Anodized Aluminum		T316SS	T302SS	T303SS	Viton [*]	Polycarbonate	T316SS	T316SS	PPS/Ceramic	Buna N	6063-T6 Aluminum	Nylon ST	
	C360 Brass ¹													
	T303SS	2024-T351 Anodized Aluminum												
Water Basic Only	C360 Brass ¹		T316SS	T302SS	T303SS	Viton [*]	Polycarbonate	T316SS	T316SS	PPS/Ceramic	Buna N	6062-T6 Aluminum	Nylon ST	
	T303SS	C360 Brass												

¹ 3" Models have Celcon[®] piston/piston ring

API Oil/Caustic and Corrosive Liquids

Meter Model	Body	Piston	Cone	Spider Plate	Spring	Fasteners	Pressure Seals	Guard	Retaining Ring	Retaining Spring	Indicator & Internal Magnet	Guard Seal/Bumper	Scale Support	End Caps
Standard	T316SS			T316SS	T316SS	T316SS	Viton*	Polycarbonate	T316SS	T316SS	PPS/Ceramic	Buna N	6063-T6 Aluminum	Nylon ST
Hostile Environment	T316SS			T316SS	T316SS	T316SS	Viton*	Cylindrical Pyrex Glass	T316SS	T316SS	Indicator: T4155 Magnet: Teflon* Coated Alnico 8	T316SS	T316SS	T316SS

High Temp Flow

Meter Model	Body	Piston	Cone	Spider Plate	Spring	Fasteners	Pressure Seals	Guard	Retaining Ring	Retaining Spring	Indicator & Internal Magnet	Guard Seal/Bumper	Scale Support	End Caps
Oil	2024-T351 Anodized Aluminum		C360 Brass	T316SS	T302SS	T303SS	Viton*	Cylindrical Pyrex* Glass	SAE 1070/1090 Carbon Steel	SAE 1070/1090 Carbon Steel	Indicator: Nickel-plated Carbon Steel	Buna N	Scale: Polymide	2011-T3 Anodized Aluminum
	T303SS	2024-T351 Anodized Aluminum									Magnet: Teflon* Coated Alnico 8		Scale Support: T316SS	
PE	2024-T351 Anodized Aluminum		C360 Brass	T316SS	T320SS	T303SS	EPR	Cylindrical Pyrex* Glass	SAE 1070/1090 Carbon Steel	SAE 1070/1090 Carbon Steel	Indicator: Nickel-plated Carbon Steel	EPR	Scale: Polymide	2011-T3 Anodized Aluminum
	T303SS	2024-T351 Anodized Aluminum									Magnet: Teflon* Coated Alnico 8		Scale Support: T316SS	
WBF	2024-T351 Anodized Aluminum		C360 Brass ¹	T316SS	T302SS	T303SS	Viton*	Cylindrical Pyrex* Glass	T316SS	T316SS	Indicator: Nickel-plated Carbon Steel	Buna N	Scale: Polymide	2011-T3 Anodized Aluminum
	T303SS	2024-T351 Anodized Aluminum									Magnet: Teflon* Coated Alnico 8		Scale Support: T316SS	
Water	C360 Brass ¹		C360 Brass	T316SS	T302SS	T303SS	Viton*	Cylindrical Pyrex* Glass	T316SS	T316SS	Indicator: Nickel-plated Carbon Steel	Buna N	Scale: Polymide	2011-T3 Anodized Aluminum
	T303SS										Magnet: Teflon* Coated Alnico 8		Scale Support: T316SS	

¹ 3" Models have Celcon¹ piston/piston ring

DIMENSIONS

Standard Meter

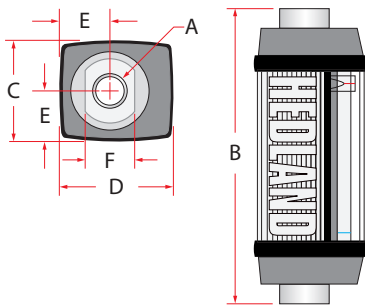

A Nominal Port Size	B Length in. (mm)	C Width in. (mm)	D Depth in. (mm)	E Offset in. (mm)	F Flats in. (mm)
1/4 in. (SAE 6)	4.80 (122)	1.68 (43)	1.90 (48)	0.82 (21)	0.88 (22)
1/2 in. (SAE 10)	6.60 (168)	2.07 (53)	2.40 (61)	1.04 (26)	1.25 (32)
3/4 in. (SAE 12)	7.20 (183)	2.48 (63)	2.85 (72)	1.24 (32)	1.50 (38)
1 in. (SAE 16)	7.20 (183)	2.48 (63)	2.85 (72)	1.24 (32)	1.75 (44)
1-1/4 in. (SAE 20)	12.20 (310)	4.12 (105)	4.72 (120)	2.06 (52)	2.75 (70)
1-1/2 in. (SAE 24)	12.20 (310)	4.12 (105)	4.72 (120)	2.06 (52)	2.75 (70)

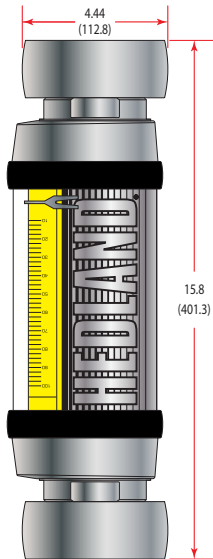
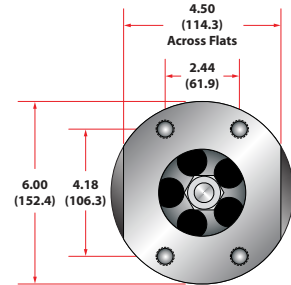
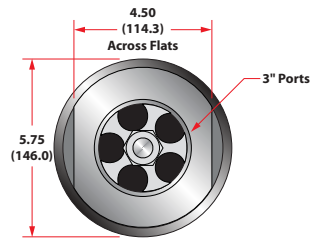
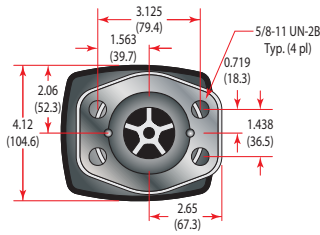

Figure 9: 1-1/2 inch; C62 Flange Inches (mm)

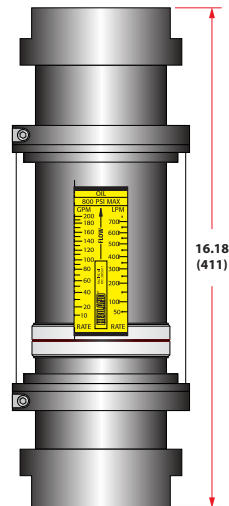

Figure 10: 3 inch; SAE, NPTF, BSPP Inches (mm)

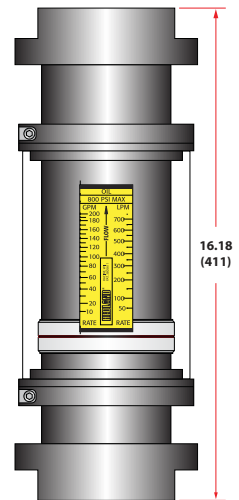
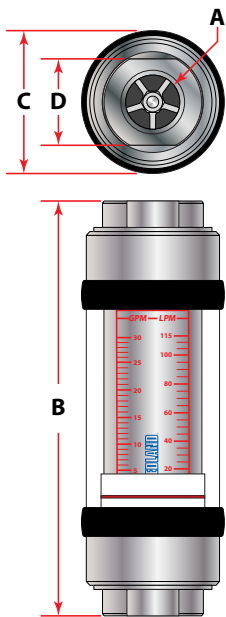

Figure 11: 3 inch; C61 Flange Inches (mm)

High Temp Meter



A Nominal Port Size	B Length in. (mm)	C Width in. (mm)	D Flats in. (mm)
1/4 in. (SAE 6)	6.60 (168)	2.01 (53)	1.25 (32)
1/2 in. (SAE 10)	6.60 (168)	2.01 (53)	1.25 (32)
3/4 in. (SAE 12)	7.20 (183)	2.48 (63)	1.50 (38)
1 in. (SAE 16)	7.20 (183)	2.48 (63)	1.75 (44)
1-1/4 in. (SAE 20)	12.20 (310)	4.20 (105)	2.75 (70)
1-1/2 in. (SAE 24)	12.20 (310)	4.20 (105)	2.75 (70)

Test Kit

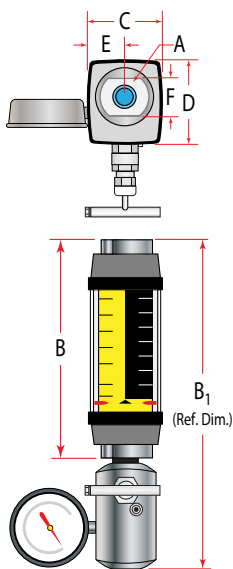

A Nominal Port Size	B Length in. (mm)	B ₁ Length in. (mm)	C Width in. (mm)	D Depth in. (mm)	E Offset in. (mm)	F Flats in. (mm)
1/2 in. (SAE 10)	6.60 (168)	9.60 (245)	2.07 (53)	2.40 (61)	1.04 (26)	1.25 (32)
3/4 in. (SAE 12)	7.20 (183)	10.70 (272)	2.48 (63)	2.85 (72)	1.24 (32)	1.50 (38)
1 in. (SAE 16)	7.20 (183)	10.70 (272)	2.48 (63)	2.85 (72)	1.24 (32)	1.75 (44)
1-1/4 in. (SAE 20)	12.20 (310)	20.50 (521)	4.12 (105)	4.72 (120)	2.06 (52)	2.75 (70)
1-1/2 in. (SAE 24)	12.20 (310)	20.50 (521)	4.12 (105)	4.72 (120)	2.06 (52)	2.78 (70)

Control. Manage. Optimize.

Hedland is a registered trademark of Badger Meter, Inc. Other trademarks appearing in this document are the property of their respective entities. Due to continuous research, product improvements and enhancements, Badger Meter reserves the right to change product or system specifications without notice, except to the extent an outstanding contractual obligation exists. © 2019 Badger Meter, Inc. All rights reserved.

www.badgermeter.com

The Americas | Badger Meter | 4545 West Brown Deer Rd | PO Box 245036 | Milwaukee, WI 53224-9536 | 800-876-3837 | 414-355-0400
 México | Badger Meter de las Americas, S.A. de C.V. | Pedro Luis Ogazón N°32 | Esq. Angelina N°24 | Colonia Guadalupe Inn | CP 01050 | México, DF | México | +52-55-5662-0882
 Europe, Eastern Europe Branch Office (for Poland, Latvia, Lithuania, Estonia, Ukraine, Belarus) | Badger Meter Europe | ul. Korfantego 6 | 44-193 Knurów | Poland | +48-32-236-8787
 Europe, Middle East and Africa | Badger Meter Europa GmbH | Nürtinger Str 76 | 72639 Neuffen | Germany | +49-7025-9208-0
 Europe, Middle East Branch Office | Badger Meter Europe | PO Box 341442 | Dubai Silicon Oasis, Head Quarter Building, Wing C, Office #C209 | Dubai / UAE | +971-4-371 2503
 Slovakia | Badger Meter Slovakia s.r.o. | Racianska 109/B | 831 02 Bratislava, Slovakia | +421-2-44 63 83 01
 Asia Pacific | Badger Meter | 80 Marine Parade Rd | 21-06 Parkway Parade | Singapore 449269 | +65-63464836
 Switzerland | Badger Meter Swiss AG | Mittelholzerstrasse 8 | 3006 Bern | Switzerland | +41-31-932 01 11