

Series D12

Gas Transmitter

With Infrared Sensor



Home Office

Analytical Technology, Inc.
6 Iron Bridge Drive
Collegeville, PA 19426

Ph: 800-959-0299
610-917-0991

Fax: 610-917-0992
Email: sales@analyticaltechnology.com

European Office

ATI (UK) Limited
Unit 1 & 2 Gatehead Business Park
Delph, New Road, Delph
Saddleworth OL35DE
Ph: +44 (0)1457-873-318

Fax: + 44 (0)1457-874-468
Email: sales@atiuk.com

Product Warranty

Analytical Technology, Inc. (Manufacturer) warrants to the Customer that if any part(s) of the Manufacturer's equipment proves to be defective in materials or workmanship within the earlier of 18 months of the date of shipment or 12 months of the date of start-up, such defective parts will be repaired or replaced free of charge. Inspection and repairs to products thought to be defective within the warranty period will be completed at the Manufacturer's facilities in Collegeville, PA. Products on which warranty repairs are required shall be shipped freight prepaid to the Manufacturer. The product(s) will be returned freight prepaid and allowed if it is determined by the manufacturer that the part(s) failed due to defective materials or workmanship.

This warranty does not cover consumable items, batteries, or wear items subject to periodic replacement including lamps and fuses.

Gas sensors carry a 12 months from date of shipment warranty and are subject to inspection for evidence of misuse, abuse, alteration, improper storage, or extended exposure to excessive gas concentrations. Should inspection indicate that sensors have failed due to any of the above, the warranty shall not apply.

The Manufacturer assumes no liability for consequential damages of any kind, and the buyer by acceptance of this equipment will assume all liability for the consequences of its use or misuse by the Customer, his employees, or others. A defect within the meaning of this warranty is any part of any piece of a Manufacturer's product which shall, when such part is capable of being renewed, repaired, or replaced, operate to condemn such piece of equipment.

This warranty is in lieu of all other warranties (including without limiting the generality of the foregoing warranties of merchantability and fitness for a particular purpose), guarantees, obligations or liabilities expressed or implied by the Manufacturer or its representatives and by statute or rule of law.

This warranty is void if the Manufacturer's product(s) has been subject to misuse or abuse, or has not been operated or stored in accordance with instructions, or if the serial number has been removed.

Analytical Technology, Inc. makes no other warranty expressed or implied except as stated above

Table of Contents



INTRODUCTION 5

IR GAS SENSOR..... 5

IR SENSOR VERSIONS 7

STANDARD LEL HYDROCARBON (HC) IR SENSOR, P/N 00-1375 7

LEL, UEL..... 9

%LEL..... 9

Target and Interferent Gases 9

Managing Interferent Gas Environments..... 9

Methane and High-Methane Target Gas Settings... 10

HIGH-RANGE HYDROCARBON (HHC) IR SENSOR, P/N 00-1376 11

STANDARD RANGE CARBON DIOXIDE (CO2) IR SENSOR, 0-5%VOL, P/N 00-1377 11

HIGH-RANGE CARBON DIOXIDE (HCO2) IR SENSOR, 0-50%VOL,P/N 00-1378 12

STANDARD RANGE NITROUS OXIDE (N2O) IR SENSOR, 0-1%VOL , P/N 00-1431 12

SPECIFICATIONS 13

INSTALLATION..... 14

HAZARDOUS LOCATIONS 14

MECHANICAL MOUNTING 15

Supporting the Transmitter 15

ELECTRICAL CONNECTIONS 16

External Power Supply..... 16

The Stack..... 16

Power Supply Board 17

 Relay Contacts 18

Wiring Examples 19

 ATI A17/B14, 3-Wire Mode 19

 Power Without 4-20mA Signaling 20

 4-20mA Signaling, Single Supply, 3-Wire Mode 21

 4-20mA Signaling, Dual Supply, 4-Wire Mode 22

 HART Transmitter, Point-to-Point, 3-Wire (Active Source) 23

 HART Transmitter, Multi-drop, 3-Wire (Active Source) 24

 RS485 Modbus Multidrop 25

 RS232 Modbus, PC Capture, or Printer 26

REMOTE SENSOR WIRING 27

CPU Board Configuration 28

OPERATION 30

Interface Panel..... 30

Startup Review Sequence 31

Main Display Page..... 32

 Five-minute Time-out Rule 32

 Esc Key Operation - Main Display Only 32

 Fault Indication..... 32

 Main Reading 33

Menu Page 33

 Setup Page 33

 Variable Editing..... 34

SENSORS..... 35

Sensor Setup Pages 35

 Sensor Target Gas, Range, Units, and LEL Variables .35

 Sensor Damping, Blanking, and Temperature Variables 36

 Sensor Cal History (Link)..... 36

Bump-Testing 37

Calibration 38

 Calibration Frequency 38

 Calibration Terminology 38

 Zero Calibration..... 38

 Span Calibration 38

 Calibration Kits 38

 Indications During Sensor Calibration..... 38

 Calibration Exceptions..... 38

 Zero Calibration with a Zero Gas Source 39

 Zeroing to the Atmosphere 39

 Zero Sensor Page 39

 Span Calibration Procedure 40

 Spanning for Safety – HC and HHC IR Sensors..... 41

Sensor Calibration Records 42

ALARMS AND RELAYS 43

Gas Concentration Alarms..... 43

 Manual Alarm Reset 43

 Remote Reset..... 43

 Gas Alarm Setup Pages 44

 Alarm Variable Functions..... 47

Fault Alarms..... 48

 Corrective Actions 48

 Alarm Relays 51

 Relay Setup Page 52

 Testing Alarm Relays 52

 Relay Test Page 52

Inhibiting Alarms..... 53

 Alarm Inhibit Setup page 53

4-20MA ANALOG OUTPUT 54

 Output Overrides 54

 4-20mA Setup Page 54

 4-20mA Control Page..... 55

 Loop Adjustment 55

DATA LOGGER 56

 Data-log Access Page 57

 Data-log Setup Page 57

 Data-log Graphic Report Page 58

 Data-log Tabular Report Page 58

 Data-log Printout 59

DISPLAY 60

 Display Setup Page..... 60

SYSTEM 61

 System Access Page 61

Real-time Clock..... 61

 Clock Setup Page..... 61



Security 62
 Security Control Page..... 62
 Activating Security..... 62
 Deactivating Security..... 63
 Changing the Password..... 63
Communications 64
 Communication Setup Page 64
 ASCII..... 65
 HART..... 65
 Modbus 67
Transmitter Version 67
Restart..... 68
Resets 68

SPARE PARTS..... 69

APPENDIX A..... 70

PRINTING DATA LOG REPORTS 70
 Serial Connection..... 70
 Communication Setup Page 70
 Flow Control..... 70
 Report Format..... 71
 Report Control 71
EXAMPLE: CHARTING A DATA LOG REPORT 72
 Starting the Report 75
 Charting with Microsoft Excel 78

List of Figures

FIGURE 1. D12 TRANSMITTER5
FIGURE 2. IR GAS SENSOR.5
FIGURE 3. SIGNAL OUTPUTS WITH AND WITHOUT GAS EXPOSURE.....5
FIGURE 4. ABSORPTION SPECTRUM AND SENSOR RESPONSE.....6
FIGURE 5. COMPARISON OF "METHANE" TO "HIGH-METHANE"
 LINEARIZATION FOR LOW CONCENTRATIONS 10
FIGURE 6. COMPARISON OF "METHANE" TO "HIGH-METHANE"
 LINEARIZATION FOR HIGH CONCENTRATIONS..... 10
FIGURE 7. OVERALL DIMENSIONS 15
FIGURE 8. ACCESSING ELECTRICAL CONNECTIONS 16
FIGURE 9. POWER SUPPLY BOARD CONNECTIONS..... 17
FIGURE 10 RELAY CONTACTS..... 18
FIGURE 11. ATI A17/B14 EXAMPLE..... 19
FIGURE 12. POWER WITHOUT 4-20mA SIGNALING EXAMPLE 20
FIGURE 13. 4-20MA SIGNALING, SINGLE SUPPLY, 3-WIRE EXAMPLE
 21
FIGURE 14. 4-20MA SIGNALING, DUAL SUPPLY, 4-WIRE EXAMPLE.. 22
FIGURE 15. HART TRANSMITTER, POINT-TO-POINT, 3-WIRE
 EXAMPLE 23
FIGURE 16. HART TRANSMITTER, MULTI-DROP, 3-WIRE EXAMPLE. 24
FIGURE 17. RS485 MODBUS MULTIDROP EXAMPLE 25
FIGURE 18. RS232 MODBUS, PC CAPTURE, PRINTER EXAMPLE 26
FIGURE 19. REMOTE SENSOR OPTION WIRING..... 27
FIGURE 20. CPU BOARD CONFIGURATION 28
FIGURE 21. OPERATORS INTERFACE PANEL 30
FIGURE 22. STARTUP REVIEW SEQUENCE..... 31
FIGURE 23. MAIN DISPLAY 32
FIGURE 24. MENU AND SETUP PAGES..... 33
FIGURE 25. VARIABLE EDITING 34
FIGURE 26. SENSOR SETUP AND GAS/RANGE/UNITS PAGES 35
FIGURE 27. DATA-LOG WARNING PAGE 35
FIGURE 28. SENSOR SETUP AND DAMP/BLANK/TEMP SETUP PAGE... 36
FIGURE 29. SENSOR CAL HISTORY (LINK) 36
FIGURE 30. ZERO CALIBRATION..... 39
FIGURE 31. ZERO_SENSOR PAGE 39
FIGURE 32 SPAN CALIBRATION..... 40
FIGURE 33. SPAN_SENSOR PAGE 40
FIGURE 34. SENSOR CALIBRATION HISTORY PAGES 42
FIGURE 35. DEFAULT ALARMS FOR COMBUSTIBLE GAS SENSORS. 43
FIGURE 36. MANUAL ALARM RESET..... 43
FIGURE 37. ALARM SETUP PAGES (EXAMPLE) 44

FIGURE 38. RISING ALARM (ACTIVE=ABOVE_SP, RESET=AUTO) 47
FIGURE 39. FALLING ALARM (ACTIVE=BELOW_SP, RESET=AUTO)
 47
FIGURE 40. FAULT ALARM (MAIN DISPLAY) 48
FIGURE 41. FAULT PAGE 48
FIGURE 42 ALARM RELAY SCHEMATIC 51
FIGURE 43. RELAY SETUP PAGE (EXAMPLE) 52
FIGURE 44. RELAY TEST PAGE EXAMPLE..... 52
FIGURE 45. INHIBITING ALARMS FROM THE MAIN DISPLAY..... 53
FIGURE 46. ALARM INHIBIT SETUP PAGE 53
FIGURE 47. CURRENT LOOP OUTPUT PLOT 54
FIGURE 48. 4-20MA SETUP PAGE 54
FIGURE 49. 4-20MA CONTROL PAGE 55
FIGURE 50. LOOP ADJUSTMENT PAGES..... 55
FIGURE 51. DATA LOG ACCESS PAGE 57
FIGURE 52. DATA LOG SETUP PAGE..... 57
FIGURE 53. DATA LOG GRAPHIC REPORT PAGE..... 58
FIGURE 54. DATA LOG TABULAR REPORT PAGE..... 58
FIGURE 55. DATA-LOG PRINTOUT..... 59
FIGURE 56. SYSTEM ACCESS PAGE 61
FIGURE 57. CLOCK SETUP PAGE 61
FIGURE 58. SECURITY CONTROL PAGE 62
FIGURE 59. ACTIVATING SECURITY..... 62
FIGURE 60. DEACTIVATING SECURITY 63
FIGURE 61. CHANGING THE PASSWORD..... 63
FIGURE 62. COMMUNICATION SETUP PAGE 64
FIGURE 63. HART SETUP PAGES 65
FIGURE 64. HART A) FIND-ME AND B) DEVICE FOUND PAGES 66
FIGURE 65. MODBUS SETUP PAGE 67
FIGURE 66. TRANSMITTER VERSION PAGE..... 67



INTRODUCTION

The D12-IR transmitter is used to continuously monitor for gas leaks in ambient air near process tanks, piping, or in enclosed spaces where gases may accumulate. The transmitter is explosion proof, and is rated for use in hazardous locations (see specifications). It features an NDIR (non-dispersive, infrared) sensor, a non-intrusive four button user interface with a back-lighted graphics display, three level alarm system with three (optional) alarm relays, high-resolution 4-20mA current loop output, real-time clock, data-logger, and optional HART™ or Modbus™ network interface.

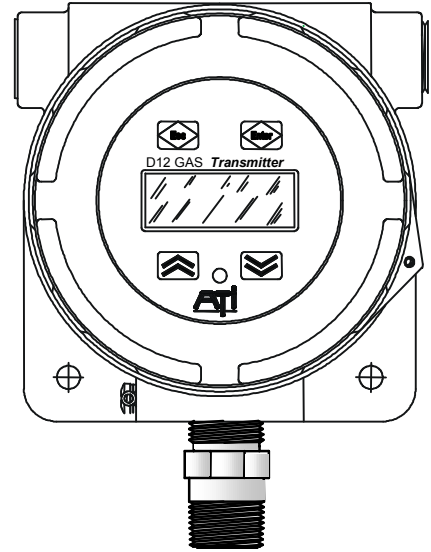
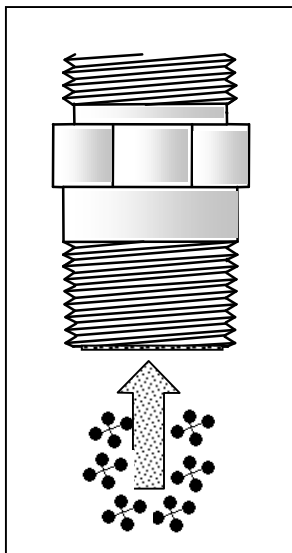

Figure 1. D12 transmitter



IR Gas Sensor

The IR sensor is housed in an explosion proof, stainless steel housing that is threaded into the base of the transmitter (or remote housing, if ordered). A porous, stainless steel frit is welded into the opposite end to permit gas entry, and to prevent possible ignition of a combustible atmosphere. Threads are cut into the sensor housing to accommodate various accessories, such as rain shields, and calibration adapters.

The working parts of the sensor consist of an infrared light source, detector, thermistor, and memory device. The light source is a thin wall, tungsten filament lamp, with an MTBF of over 5 years. It is pulsed at 2 Hz to provide excitation to the detector, and as a side benefit, warms the components of the sensor. This helps to prevent water vapor from condensing on the interior surfaces of the sensor, which could lead to excessive drift, or even false alarms.

Figure 2. IR gas sensor.

The detector is a dual element, pyroelectric design. The elements, labeled “active” and “reference”, are piezo crystals that distort when heated, and generate a small charge in response to radiation pulses emitted by the lamp. Specially designed, optical filters cover each element. The active element is covered by an optical filter that passes radiation in a band that will be absorbed by a target gas, such as Methane. Its output will decrease in amplitude when the gas is in the path of the lamp’s radiation. The “reference” element has an optical filter whose pass-band is outside of the active element’s filter, and is unaffected by the presence of the target gas. It is used primarily to compensate for slight variations of lamp intensity, humidity, and other environmental factors.

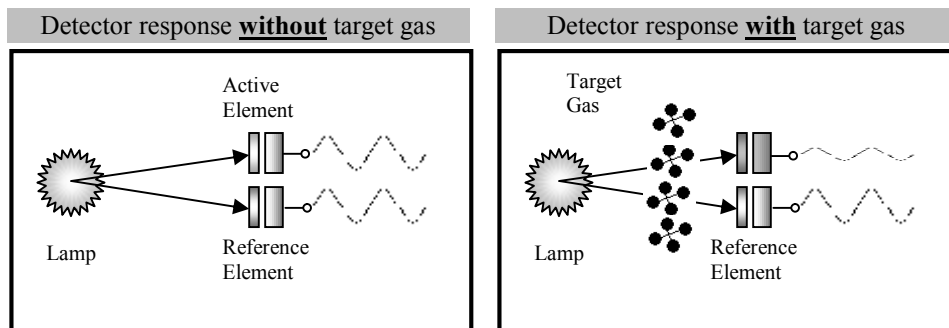

Figure 3. Signal outputs with and without gas exposure.

The signal output of an element is proportional to the amount of filtered radiation reaching it. When an IR absorbing gas enters the optical path, it reduces the radiation reaching the active element by an amount that is a function of the gas type, and concentration. The figure below illustrates the absorption spectra of both Methane and Propane at identical concentrations, overlaid with the filter pass-bands of the Standard LEL Hydrocarbon sensor (P/N 00-1375). To the right of each spectrum is a graph of the sensor's relative, fractional absorption (FA) plotted over the same concentration range.

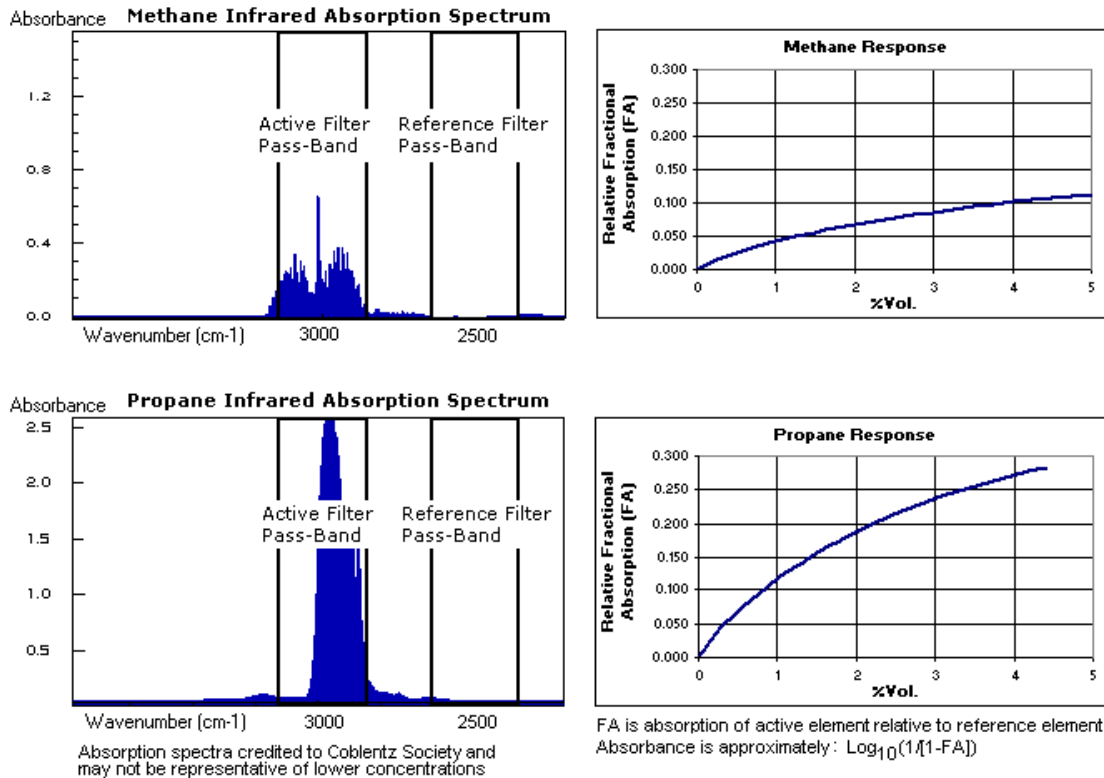

Figure 4. Absorption spectrum and sensor response

The transmitter's CPU monitors the output from each element, computes a fractional absorption value and linearizes it into a gas concentration reading in units of %LEL, or %V/V. The linearization function is derived from Beer's Law, The CPU also monitors the sensor's thermistor output and, if required, corrects the concentration readings over its specified temperature range.

The memory of the sensor stores a table of information about one or more target gasses, including names, ranges, alarm settings, linearity, sensitivity, and calibration status information. Once the factory has calibrated the sensor with one or more gasses listed in the table, any one of those gasses may be selected for monitoring at the customer site. In addition to the gas table, the sensor memory stores a calibration history. The history includes room for 63 zero, and 63 span calibration records, before rolling over.

IR Sensor Versions

Table 1. IR sensor versions.

Part No.	Abbreviation	Description
00-1375	HC	Standard LEL (low range) hydrocarbon sensor for Methane, Propane, Butane, Pentane, etc.
00-1376	HHC	High range hydrocarbon sensor for high concentrations (normally above the UEL) of Propane, Butane, LPG.
00-1377	CO2	Standard range Carbon dioxide sensor
00-1378	HCO2	High range Carbon dioxide sensor
00-1431	N2O	Standard range Nitrous oxide sensor

Sensors are not approved for monitoring Acetylene.

Standard LEL Hydrocarbon (HC) IR Sensor, P/N 00-1375

Table 2.

Target gas settings for the standard LEL hydrocarbon IR sensor

The HC version of the IR sensor is designed to detect leaks of Methane, Propane, Butane, and other combustible gasses.

With so many potentially explosive, hydrocarbon gasses in use today, this sensor has the largest table of target gases. Each gas must be span calibrated at the factory to permit its selection in the field.

Target Gas Setting	LEL %V/Air	UEL * %V/Air	Default FS Range %LEL	Default Caution %LEL	Default Warning %LEL	Default Alarm %LEL	FA% @LEL
Methane	5.0	15.0	100	-10 ▾	20 ▲	50 ▲	11
Ethane	3.0	12.4	100	-10 ▾	20 ▲	50 ▲	10
Propane	2.2	10.0	100	-10 ▾	20 ▲	50 ▲	20
n-Butane	1.8	9.0	100	-10 ▾	20 ▲	50 ▲	19
Pentane	1.5	7.8	100	-10 ▾	20 ▲	50 ▲	16
Hexane	1.2	7.4	100	-10 ▾	20 ▲	50 ▲	13
Cyclohexane	1.3	8.4	100	-10 ▾	20 ▲	50 ▲	4
Ethyl acetate	2.2	11.0	100	-10 ▾	20 ▲	50 ▲	11
Dimethyl - formamide (DMF)	2.2	15.2	100	-10 ▾	20 ▲	50 ▲	10
Acetone	2.6	13.0	100	-10 ▾	20 ▲	50 ▲	10
Toluene	1.2	7.1	100	-10 ▾	20 ▲	50 ▲	11
Benzene	1.3	7.1	100	-10 ▾	20 ▲	50 ▲	11
High-Methane ¹	5.0	15.0		Off	Off	Off	---

Contact factory for complete list.

* Information only, HC sensor **not approved** for monitoring above LEL concentrations, except on High-Methane setting.

¹ **Not approved** for monitoring concentrations at or below the LEL of any gas.

--- Not applicable, or not available at time of publication, contact factory.

Unlike a catalytic bead sensor, compounds of Silicon do not poison the sensor, nor does it rely on atmospheric Oxygen. Although not entirely accurate above the target gas LEL, readings will not decrease when exposed to a

100%Vol. concentration of the target gas. In addition, the sensor can operate in a 100%Vol. Methane environment (only on the High-Methane setting, see below).

LEL, UEL

Various hydrocarbon gases become explosive when mixed with air at, or above, a concentration limit referred to as the LEL (Lower Explosive Limit). For Methane, the LEL concentration is 5% by volume, in air, labeled as 5%V/Air. As more gas is mixed with air, the concentration rises and remains explosive, until it reaches the UEL (Upper Explosive Limit). Above the UEL, the concentration is considered non-explosive. For Methane, the UEL concentration is 15%V/Air.

%LEL

Various gas selections cause the transmitter to report combustible gas concentrations as a percentage of the LEL, or %LEL. For example, 2.5%V/Air of Methane would be reported as 50%LEL, and so on. A reading at or above 100%LEL indicates a dangerous, explosive environment exists at the transmitter, and every effort to evacuate personnel and prevent ignition should be taken.

By default, gasses listed in this sensor’s table report concentration in units of %LEL, have alarms set at: C=-10, W=20 and A=50 %LEL, and are not permitted to have alarms set above 60%LEL (exception: High-Methane).

Target and Interferent Gases

Any gas or vapor that absorbs IR in the pass-band of the active detector element will cause a positive response of the sensor. This principle permits a sensor to be used for monitoring more than one gas – but not at the same time. The IR sensor cannot distinguish one gas type from another, however; it can be calibrated for any gas that causes a positive response. Once calibrated (by the factory), that gas may be selected for monitoring at the customer site, and is referred to as a “target” gas. Once a target gas has been selected, any other gas that causes the sensor to respond (especially other target gases) is considered to be an “interferent” gas. Since the Standard LEL Hydrocarbon sensor has highest number of possible interferent gasses, a discussion of how to manage them appears below.

Managing Interferent Gas Environments

As mentioned above, the Standard LEL Hydrocarbon sensor has the largest number of possible target gases, and since it may only monitor one at a time, it also has the largest number of possible interferent gases. In the best case, an interferent gas may cause nuisance alarms. In the worst case, it may pose an undetected, explosive, or deadly toxic atmosphere.

In locations where one or more IR absorbing gases may be present, select the target gas with the lowest FA (fractional absorption) at the LEL of the gas. This value is shown for most target gases in the table above as FA%@LEL. For example, consider the case where both Methane and Propane are piped through a confined space that must be monitored for potential leaks. The fractional absorption levels are found in table 2 above:

Methane	5.0	15.0	100	-10▼	20▲	50▲	11
Ethane	3.0	12.4	100	-10▼	20▲	50▲	---
Propane	2.2	10.0	100	-10▼	20▲	50▲	20

In this case, Methane’s 11 is less than the 20 for Propane, so we would select Methane as the target gas. If, by mistake, we were to make Propane the target gas, and subsequently experience a leak of Methane, the fractional absorption level would need to rise to 12.5 (the 50%LEL level of Propane) before triggering the alarm. A Methane leak would form an explosive mixture below that level, and therefore go undetected. Although a Propane leak might result in a false Methane alarm, the space would not be explosive.

Methane and High-Methane Target Gas Settings

The sensor provides the “Methane”, and “High-Methane” settings to improve the accuracy of readings for low and high concentrations of Methane. As can be seen below, the “shape” of the sensor’s response at lower concentrations differs from that at higher concentrations, and the accuracy of readings can be improved by using a linearization function that more closely fits the response of the sensor.

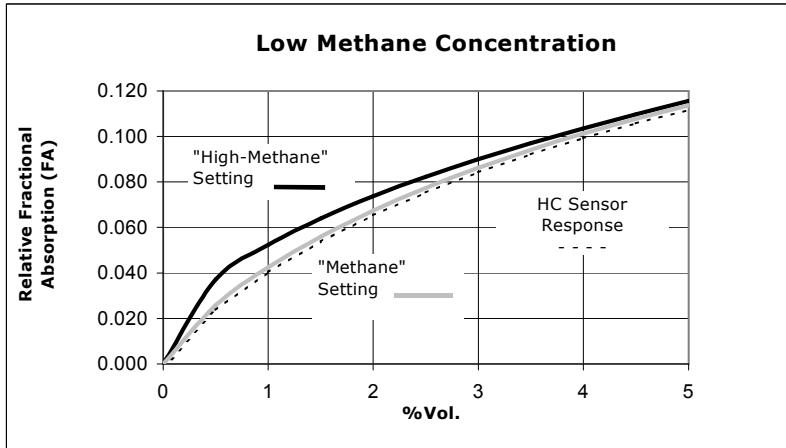

Choose the “Methane” setting when monitoring Methane concentrations below the LEL. This setting is typically used for detecting leaks in piping, and around storage tanks. This setting is not recommended for monitoring above the UEL (15%Vol).

Figure 5. Comparison of "Methane" to "High-Methane" linearization for low concentrations

Choose the “High-Methane” setting when monitoring Methane concentrations above the UEL (15%Vol.). This setting is typically used for process gas monitoring, or applications other than leak detection.

This setting is not recommended for monitoring below the LEL (5%Vol).

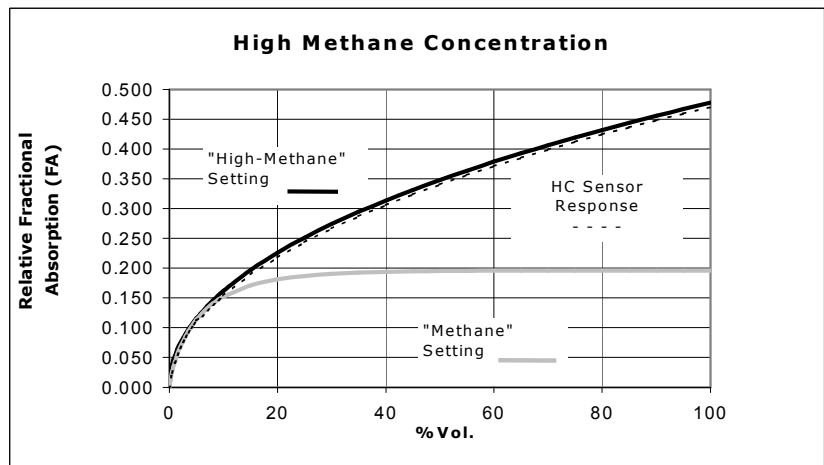

Figure 6. Comparison of "Methane" to "High-Methane" linearization for high concentrations.

High-range Hydrocarbon (HHC) IR Sensor, P/N 00-1376

This version is designed to monitor high concentrations of hydrocarbon gas in locations where high concentrations are likely to exist normally, and usually above the UEL of the respective gas. Gases listed in this sensor’s table include Propane, n-Butane, and LPG. Each gas must be span calibrated at the factory to permit its selection in the field. This sensor is **not recommended** for Methane, and is **not recommended** for monitoring concentrations at or below the LEL of any gas. For these applications, please use P/N 00-1375, Standard LEL Hydrocarbon IR Sensor.

Table 3. Target gas settings for the High-range Hydrocarbon IR Sensor

Target Gas Setting	FS Range (Min,Max)	Default Caution	Default Warning	Default Alarm
Propane	100 %V/V (10,100)	Off	Off	Off
n-Butane	100 %V/V (10,100)	Off	Off	Off
LPG	100 %V/V (10,100)	Off	Off	Off

Contact factory for complete list.
HHC sensor **not approved** for monitoring concentrations at or below the LEL of any gas.

By default, gasses listed in this sensor’s table report concentration in units of %V/V (equivalent to %V/Air, or %Vol), and have their alarms disabled. Alarms may be enabled, and programmed to activate on either rising or falling concentration levels.

Standard range Carbon Dioxide (CO2) IR Sensor, 0-5%Vol, P/N 00-1377

Table 4. Target gas settings for the Standard-range Carbon Dioxide IR Sensor

Target Gas Setting	FS Range (Min,Max)	Default Caution	Default Warning	Default Alarm
CO2	1.0 %V/V (1.0,5.0)	-0.1 %V/V ▼	0.2 %V/V ▲	0.5 %V/V ▲
Low-CO2	2000 PPM (2000,5000)	-200 PPM ▼	2000 PPM ▲	5000 PPM ▲

Contact factory for complete list.

This version provides a “CO2”, and “Low-CO2” setting to improve the accuracy of readings for high and low concentrations of Carbon dioxide. The “shape” of the sensor’s response at lower concentrations differs from that at higher concentrations, and the accuracy of readings are improved by using the linearization that more closely fits the response of the sensor.

High-range Carbon Dioxide (HCO₂) IR Sensor, 0-50%Vol,P/N 00-1378

Table 5. Target gas settings for the High-range CO₂ IR Sensor

Target Gas Setting	FS Range (Min,Max)	Default Caution	Default Warning	Default Alarm
CO ₂ ¹	10.0 %V/V (5.0,50.0)	Off	Off	Off

¹ **Not approved** for monitoring Carbon dioxide STEL (short-term exposure limit)
Contact factory for complete list.

Standard range Nitrous Oxide (N₂O) IR Sensor, 0-1%Vol , P/N 00-1431

Table 6. Target gas settings for the Standard-range N₂O IR Sensor

Target Gas Setting	FS Range (Min,Max)	Default Caution	Default Warning	Default Alarm
N ₂ O ¹	0.5 %V/V (0.2,0.5)	Off	Off	Off

¹ **Not approved** for monitoring Nitrous oxide STEL (short-term exposure limit)
Contact factory for complete list.



SPECIFICATIONS

Table 7. Specifications

Standard IR Sensor	<u>Standard LEL Hydrocarbon (HC) IR Sensor</u> , P/N 00-1375 For %LEL Methane, Ethane, Propane, n-Butane, and more (contact factory)
Optional IR Sensors	<u>High-range Hydrocarbon (HHC) IR Sensor</u> , P/N 00-1376 Range 10-100 %VOL Propane, n-Butane, and LPG <u>Standard/low range Carbon Dioxide (CO2) IR Sensor</u> , P/N 00-1377 Range: 1-5 %VOL / Low range: 2000-5000 PPM <u>High-range Carbon Dioxide (HCO2) IR Sensor</u> , P/N 00-1378 Range: 5-50 %VOL <u>Standard range Nitrous Oxide (N2O) IR Sensor</u> , P/N 00-1431 Range: 0.2-1.0 %VOL
Response Time	T90 < 30 seconds
Accuracy	Standard IR sensor: ±2%LEL (0.1%VOL) Methane Optional sensors: +/- 2% of minimum range of target gas
Repeatability	Standard IR sensor: ±2%LEL (0.1%VOL) Methane Optional sensors: ±2% of minimum range of target gas
Zero Drift	Standard IR sensor: ±1%LEL (0.05%VOL) Methane, per month Optional sensors: +/-1% of minimum range of target gas, per month
Span Drift	Standard IR sensor: ±1%LEL (0.05%VOL) Methane, per month Optional sensors: ±1% of minimum range of target gas, per month
Humidity Range	0 to 95 %RH non-condensing
Analog Output	4-20mA, 675 ohms max. at 24 VDC, current sourcing
AO Range	Standard IR sensor: 4mA is 0%LEL, 20mA is 100%LEL (programmable down to 50%LEL) Optional sensors: 4mA is 0, 20mA is programmed gas range.
Serial Interface	HART® 1200 baud modem interface, registered DDL file, or Modbus ® 1200-600,14.4k,28.8k, RS232/RS485, or ASCII text output for printing data log
Power	12 to 30 VDC (250 mA @ 24VDC maximum, 3-wire mode)
Alarm Relays	(3) SPST, contacts are rated at 5A@250 VAC, resistive load
Relay Coils	Normally energized or de-energized, programmable
Enclosure	Explosion-proof, Class 1, Div. 1, Groups B, C, & D.
Controls	Non-intrusive (4 magnetic switches on front of transmitter)
Operating Temp	-40° to +75° C
Weight	4 Lbs. (1.8 Kg.)
Remote Sensor	Optional, 25ft. Max.



INSTALLATION

HAZARDOUS LOCATIONS

D12-IR transmitters are designed for use in hazardous locations rated Class 1, Division 1, Group B, C, or D. The transmitter should not be used in Group A environments (atmospheres containing Acetylene).

When installing in a hazardous locations:

- 1) Connect the transmitter housing to earth ground.
- 2) Run wires in explosion-proof conduit and use an explosion-proof seal at the transmitter entry.
- 3) Seal the conduit entry both inside and outside of the transmitter housing to prevent condensation from leaking into the enclosure.
- 4) Follow national, state, and local electrical codes.

The transmitter can detect a variety of combustible gases and vapors. For gases that are heavier than air, such as Butane, sensors should be mounted near the floor. If the gas vapor has a density near that of air, locate the sensor about 5 feet above the floor in enclosed areas. Gas sensors mounted outdoors should be located near anticipated leak sources (valves, flanges, and compressors) and the location will depend on normal wind patterns and anticipated employee activity areas.

The following table lists common gases, along with their relative density (air = 1.00). Densities less than one indicate gases that are lighter than air while those with densities greater than one are heavier than air. Combustible vapors from most solvents, such as Benzene, n-Hexane, Methanol, Ethanol, and MEK, are heavier than air and will tend to accumulate near the floor in enclosed spaces with little air movement.

Table 8. Gas densities relative to air.

Gas Name	Density Relative to Air
Methane	0.55
Ethane	1.05
Propane	1.55
Butane	2.11
Carbon dioxide	1.53
Nitrous oxide	1.53

MECHANICAL MOUNTING

Figure 6 shows the dimensions of the transmitter enclosure, and location and size of the electrical conduit opening. When used in a classified area, an explosion-proof seal should be installed as required by the local electrical code. If conduit is used, it must also be sealed internally at the housing entry to prevent condensation inside the conduit draining into the enclosure.

Failure to seal the conduit entry or cable gland will result in water entering the enclosure causing damage to, or failure of, the transmitter electronics.

The transmitter should be mounted with the sensor facing down. Transmitters are shipped with a protective plastic cap over the sensor that should be left in place during installation, and removed before placing the transmitter in service (leave the cap installed whenever painting around the transmitter).

Remove protective cap from sensor prior to operation.

Supporting the Transmitter

The transmitter should be secured to a wall or flat surface through two mounting holes in the enclosure, as shown in Figure 7. If proper conduit fasteners are used, the transmitter enclosure may be supported by conduit alone.

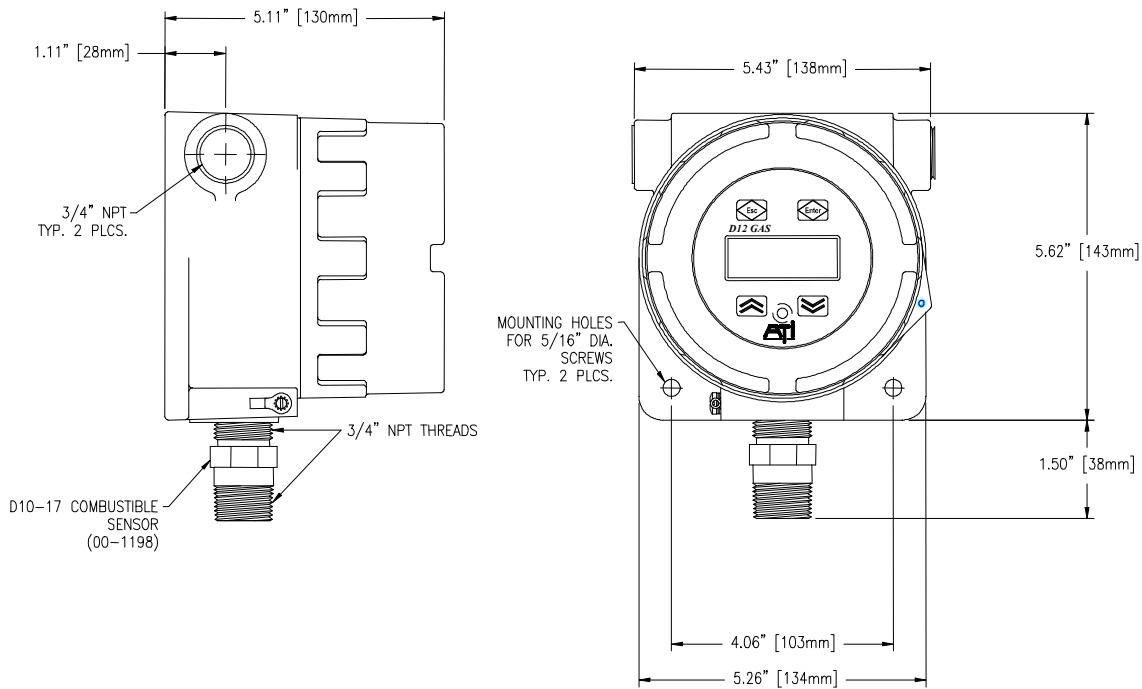

Figure 7. Overall dimensions

ELECTRICAL CONNECTIONS

External Power Supply

The transmitter requires a regulated DC supply, operating between 12 and 30 VDC. Transmitters ordered with relays will require a maximum current of 250mA, worst case (all relays energized). Power supplies for operating multiple units should be sized for twice the calculated load to allow for start-up (inrush) current.

The Stack

The transmitter consists of three circuit boards, known collectively as the “stack”. From top to bottom, they are the, Display, CPU, and Power Supply. The top two boards, Display and CPU, are fastened together with metal standoffs, and plug into the Power Supply board, which is fastened to the lower housing with similar metal standoffs. Since most external wiring connections are made to terminals on the Power Supply board, it will be necessary to remove the top two boards.

Please be aware of the hidden ribbon cable that connects the top two boards to the sensor. This cable is only long enough to permit the boards to come free from the housing.

To remove the top boards, unscrew the transmitter housing cover and turn off the power switch, SW5, located at the 12 o’clock position on the CPU board. Grasp the outer edge of the metal faceplate covering the Display board and gently rock it side to side, while pulling it up, and away from the housing. Once the top boards come free, lift them out and disconnect the sensor ribbon cable (note: this connector is keyed for ease of reconnecting later).

Set switch SW5 to OFF before removing the upper board stack from the transmitter. Since SW5 does not disconnect power at the terminals of the Power Supply Board, declassify hazardous areas prior to opening the transmitter housing.

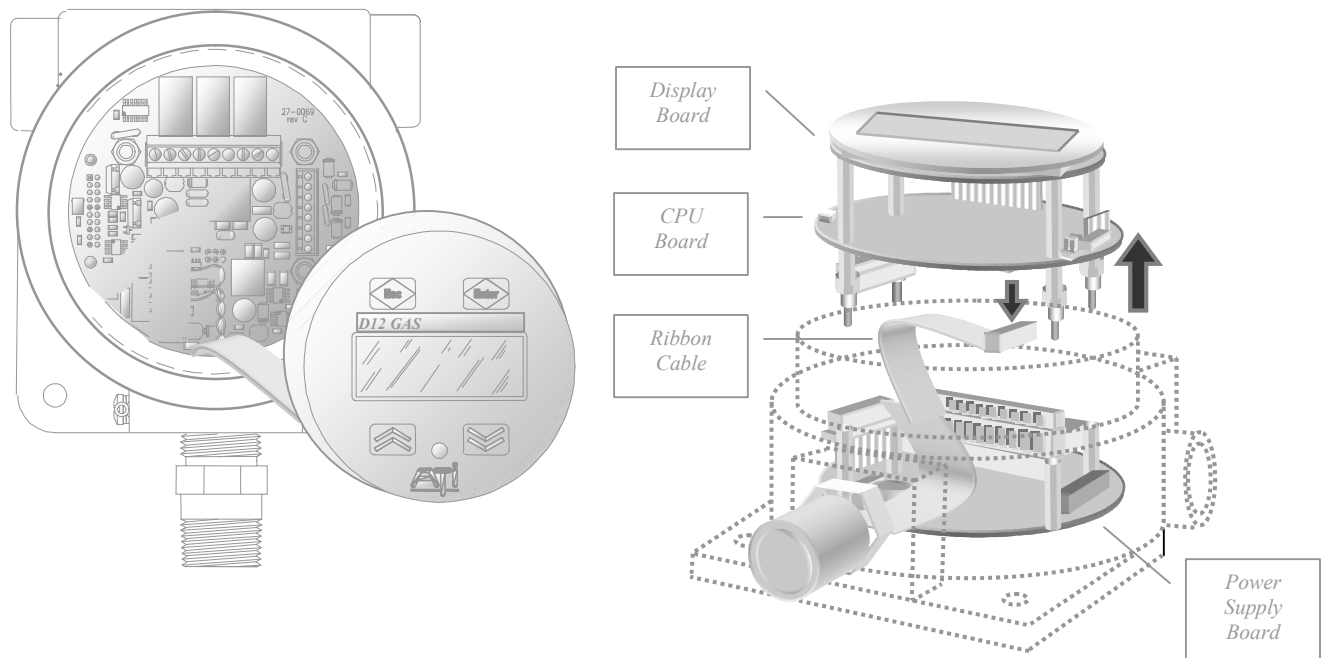

Figure 8. Accessing Electrical Connections

Power Supply Board

Electrical connections are made to terminal blocks TB1 and TB2. The 4-20mA current loop, optional digital communications, and remote alarm reset, are connected at TB1. Connections to the three optional relays are made at TB2. It is recommended to power the transmitter, and all controls and indicators, from separate, uninterruptable supplies.

Note: This version of the transmitter cannot operate on loop power alone.

The transmitter requires primary power in the range of 12 to 30 VDC applied to pins 7 and 8 on TB1. Current loop operation requires power in the same range on pin 5 (mA+), from which the transmitter sources a positive, 4-20mA output on pin 6 (mA-).

IMPORTANT

The loop supply voltage on pin 5 must not exceed the primary supply voltage on pin 8.

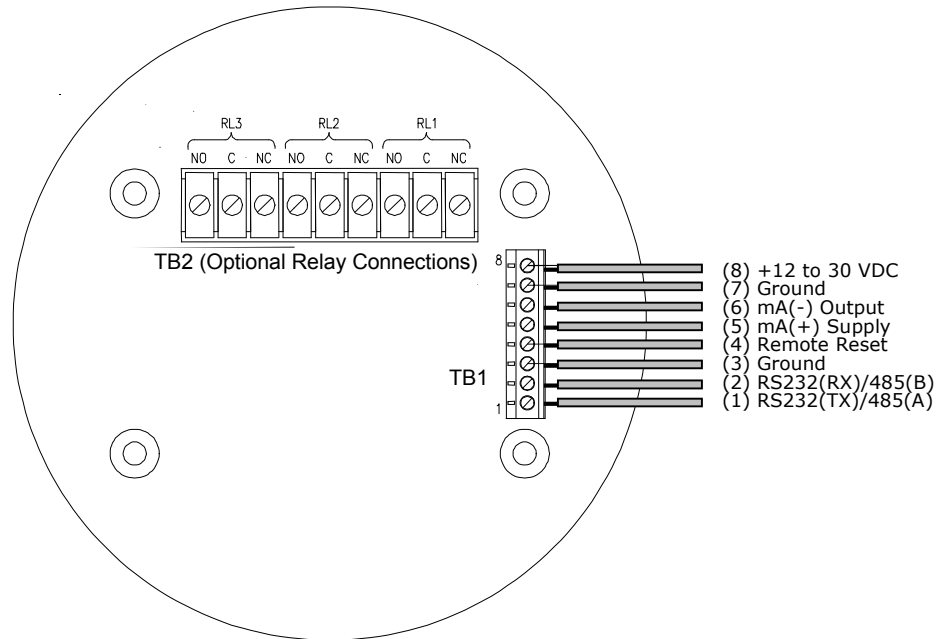

Figure 9. Power supply board connections.

In 3-wire mode, the transmitter requires a maximum of 250 mA, with all relays active. Power supplies operating multiple units should be sized for twice the calculated current requirement to allow for inrush current during startup.

The housing has limited space for wire. Use the smallest gauge wire available that is compatible with electrical code and current requirements. When powering a group of transmitters in 3-wire mode from the same power supply, 12 AWG wire is recommended for long runs, with smaller (higher gauge) wire drops to each transmitter.

Internal relays are best used as pilot relays if heavy load switching is desired. Use suitable arc suppression devices across loads switched through internal relays.

The transmitter housing may be grounded through explosion proof conduit. In the absence of such conduit, use a suitable grounding strap to bond the transmitter's housing to earth ground.

Always follow wiring practices governed by local, state, and national electrical codes.

Relay Contacts

Note: the behavior described below is determined by the default relay settings, which may be reprogrammed through the operator or communication interface.

By default, RL1 is de-energized until the gas concentration reaches the Warning level, and is then energized until the alarm is cleared, or power fails. Likewise, RL2 is de-energized until the gas concentration reaches the Alarm level, and is then energized until the alarm is cleared, or power fails. In contrast, RL3 is energized until a Fault condition is detected, or power fails, and is then de-energized until the condition is cleared.

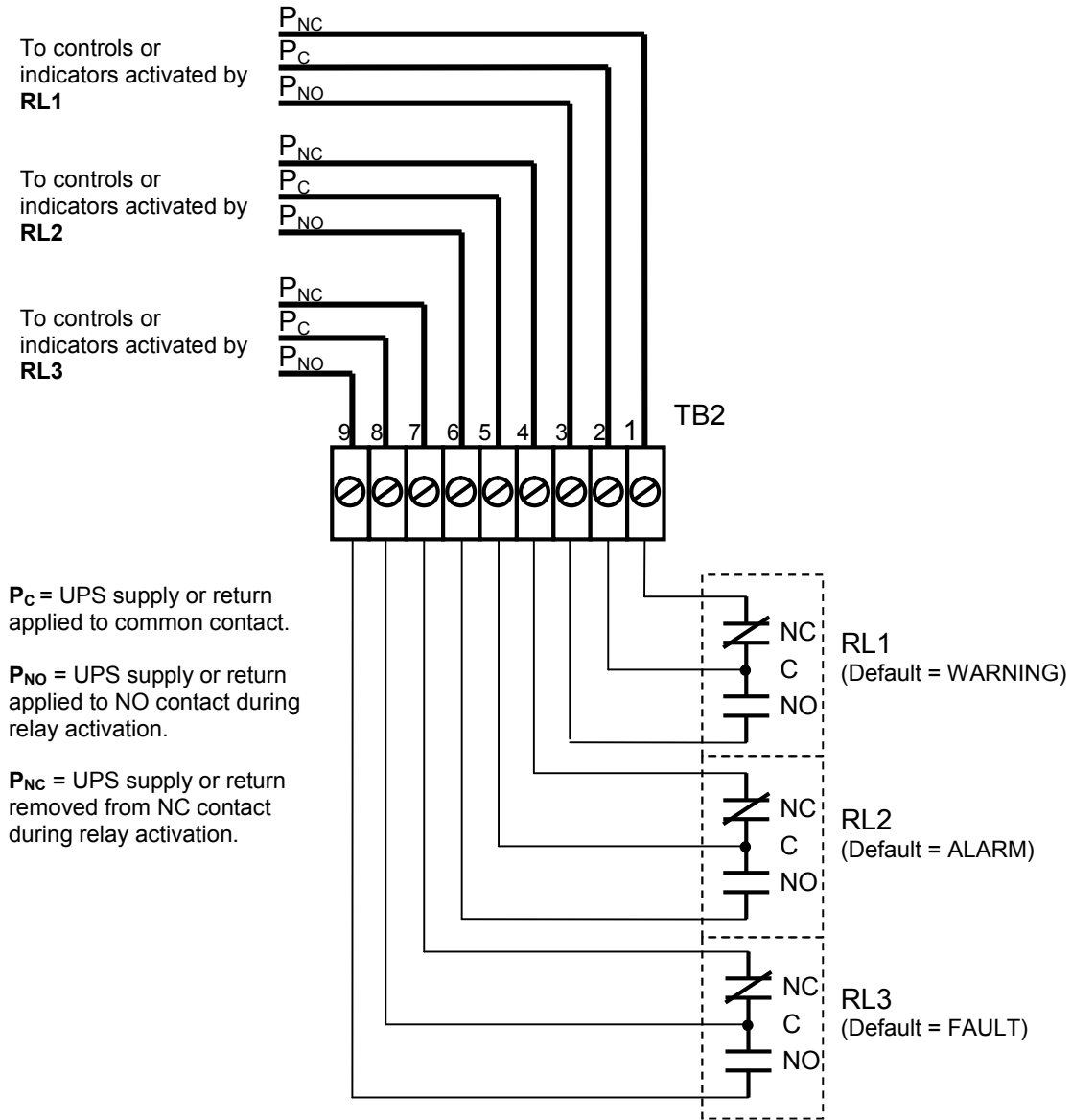

Figure 10 Relay Contacts

Wiring Examples

ATI A17/B14, 3-Wire Mode

A single ATI A17 may be used to power one D12-IR transmitter in 3-wire mode and one ATI B14 receiver (see B14 Monitor O&M Manual).

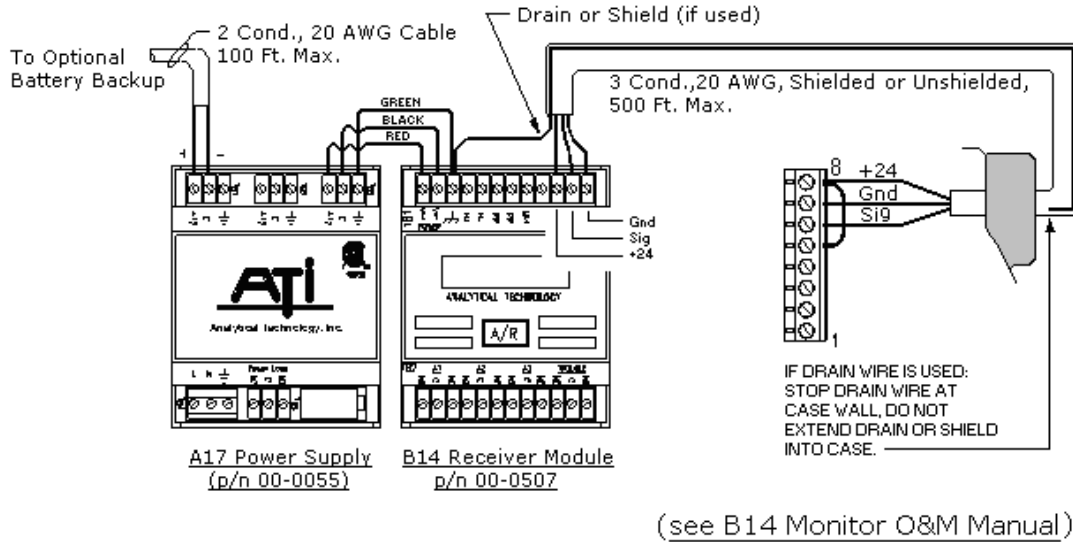

Figure 11. ATI A17/B14 Example

Power Without 4-20mA Signaling

Power without 4-20mA signaling is not common practice, except when signaling digitally over HART multidrop and Modbus connections. There are several examples of those in the pages that follow.

When 4-20mA signaling is not used, the transmitter may be powered solely from TB1-7 and 8, which are connected directly to the supply (note 1). Multiple transmitters may be powered this way, as shown. Size each power supply according to the number of transmitters, the current demand of each (see specifications), and the wire resistance. The wire resistance must not be allowed to drop the primary supply voltage below 10V at the primary supply terminals of any transmitter. Hint: If possible, use 12-14 AWG wire on primary supply connections, keep the number of transmitters low, and verify the voltage on the on the transmitter furthest from the supply.

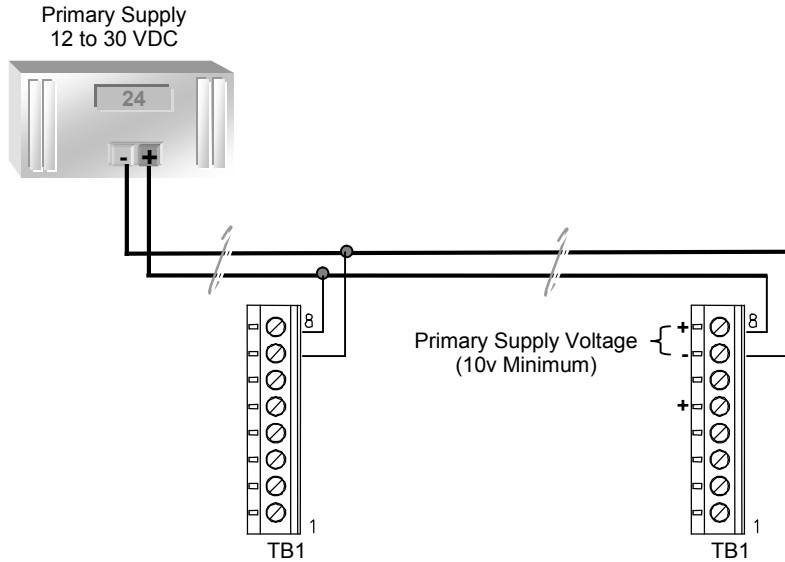

Figure 12. Power Without 4-20mA Signaling Example

Notes

1. Power without 4-20mA signaling is not common practice, except for HART multidrop or Modbus connections that use digital signaling (not shown), providing a local alarm, or both. Power shown above is sufficient for Modbus connections, relays, and LCD backlight operation.

4-20mA Signaling, Single Supply, 3-Wire Mode

The transmitter will source current to a loop receiver as shown. A single power supply provides both primary and loop power to the transmitter. Size each power supply according to the number of transmitters, the current demand of each (see specifications), and the wire resistance. The wire resistance must not be allowed to drop the Primary Supply Voltage below 10V at the terminals of any transmitter. Hint: if possible, use 12-14 AWG wire on supply connections (shown in bold).

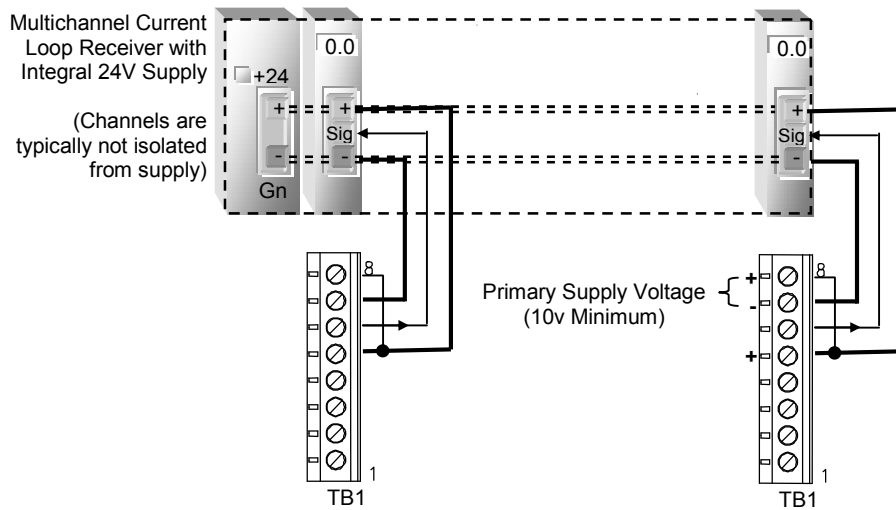

Figure 13. 4-20mA Signaling, Single Supply, 3-Wire Example

4-20mA Signaling, Dual Supply, 4-Wire Mode

To reduce the power requirement of a single current loop supply, the transmitter may be powered from both a primary and loop supply, providing the following conditions are met.

1. Supply grounds are directly connected to minimize ground loops, and,
2. The Primary Supply Voltage must not drop below the Loop Supply Voltage, as measured at instrument terminals.

Size each power supply according to the number of transmitters, the current demand of each (see specifications), and the wire resistance. The wire resistance must not be allowed to drop the Primary Supply Voltage below the Loop Supply Voltage, as measured at the terminals of any transmitter. Hint: select a Primary Supply with a higher voltage output than the Loop Supply, and use 12-14 AWG wire, if possible. Keep the number of transmitters supplied by the Primary Supply low, and verify the voltages at the terminals of the transmitter furthest from the Primary Supply.

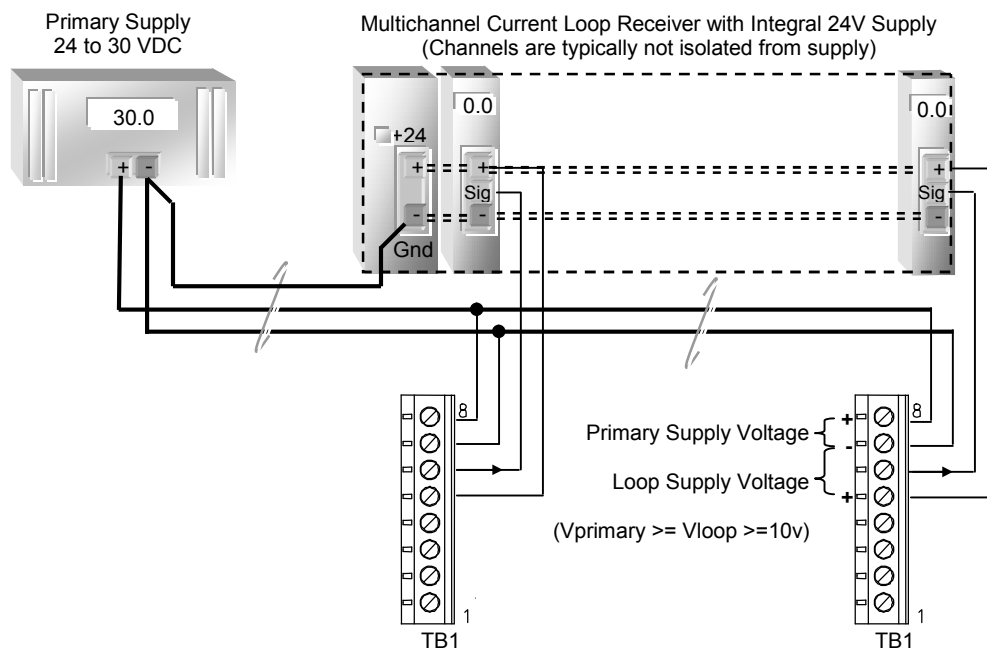

<p>IMPORTANT Primary Supply Voltage must not drop below Loop Supply Voltage at terminals of any transmitter.</p> <p>Hint: Use 12 AWG wire on Primary supply connections to minimize voltage drops.</p>	<p>1 Select a Primary Supply with a higher voltage output, and,</p> <p>2 Connect supply commons to minimize ground loops and voltage drops that might reduce the Primary Supply Voltage below the Loop Supply Voltage, at transmitter.</p>
------------------------------------------------------------------------------------------------------------------------------------------------------------------------------------------------------------------------------------	--------------------------------------------------------------------------------------------------------------------------------------------------------------------------------------------------------------------------------------------

Figure 14. 4-20mA Signaling, Dual Supply, 4-Wire Example

HART Transmitter, Point-to-Point, 3-Wire (Active Source)

The HART “Point-to-Point” connection permits the transmitter to communicate digitally, while retaining the functionality of its 4-20mA current loop. Setting the transmitter’s polling address to 0 permits the current loop to function normally. According to HART specifications, the current loop must be terminated with a load resistor between 230 and 1100 ohms; however, transmitter specifications restrict the maximum analog output resistance to a lower value (see Specifications). The term, “active source”, refers to a transmitter that is not loop powered, and sources current from power applied to it on separate terminals. Size the power supply according to the number of transmitters, the current demand of each transmitter (see specifications), and wire resistance. Wire resistance must not be allowed to drop the Primary Supply Voltage below 10V at the terminals of any transmitter. Hint: use at least 14 AWG wire on supply connections (shown in bold).

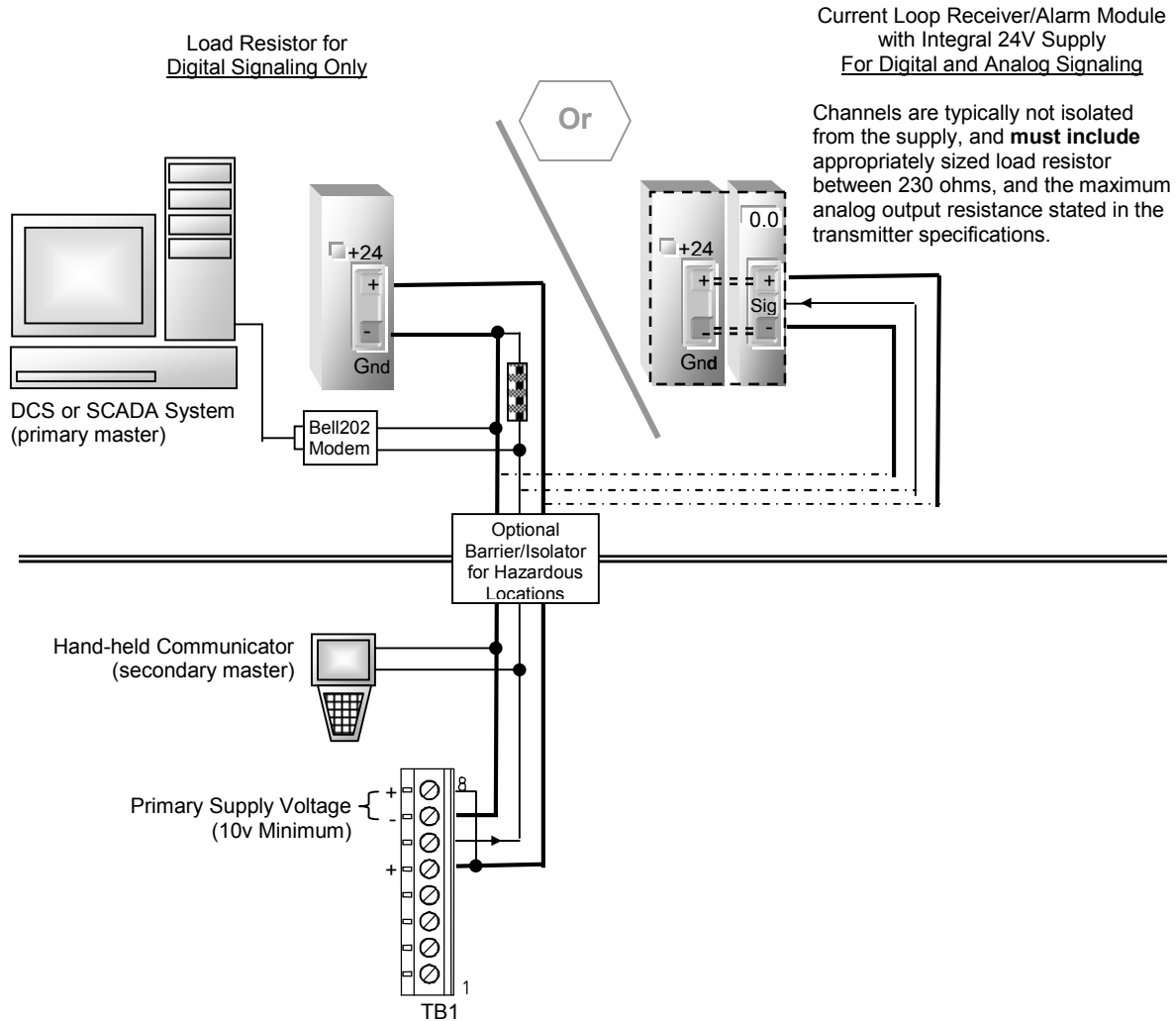

Figure 15. HART Transmitter, Point-to-Point, 3-Wire Example

HART Transmitter, Multi-drop, 3-Wire (Active Source)

The HART “Multi-drop” connection permits up to 15 transmitters to communicate digitally on the same bus, but at the cost of analog current signaling. Setting the transmitter’s polling address from 1 to 15 fixes the current loop output at 4mA. According to HART specifications, the current loop must be terminated with a load resistor between 230 and 1100 ohms; however, transmitter specifications restrict the maximum analog output resistance to a lower value (see Specifications). The term, “active source”, refers to a transmitter that is not loop powered, and sources current from power applied to it on separate terminals. Size the power supply according to the number of transmitters, the current demand of each transmitter (see specifications), and wire resistance. Wire resistance must not be allowed to drop the Primary Supply Voltage below 10V at the terminals of any transmitter. Hint: use at least 14 AWG wire on supply connections (shown in bold).

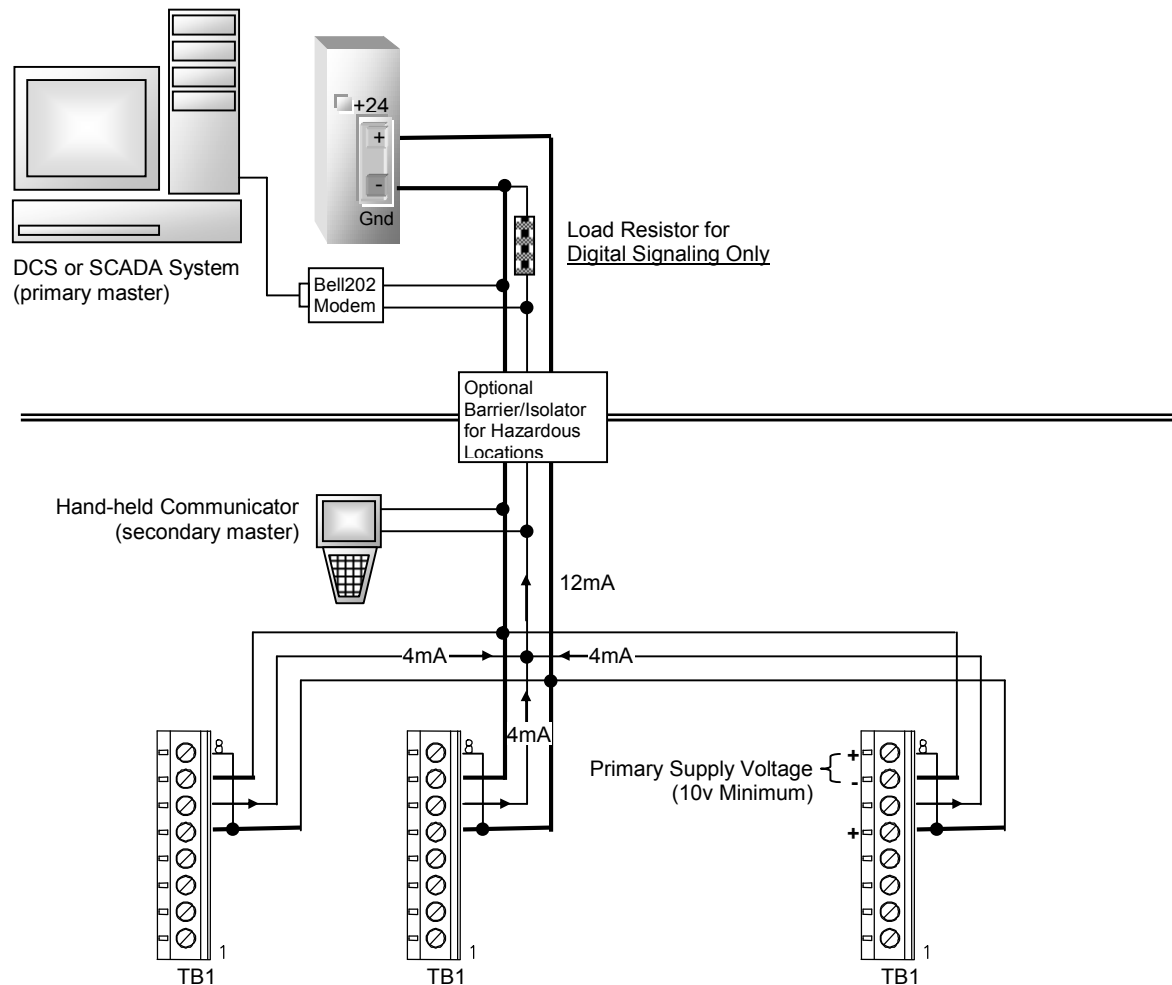

Figure 16. HART Transmitter, Multi-drop, 3-Wire Example

RS485 Modbus Multidrop

RS485 operation requires the transmitter to be wired in 3- or 4- wire mode. In addition, the RS485 or RS485 UNTERMINATED COM jumper must be installed at JP4 on the CPU. Modbus permits up to 247 devices to communicate digitally on the same bus; however, RS485 limits this to 32. Refer to the **Modbus Interface Manual** for details on Modbus connections and implementation.

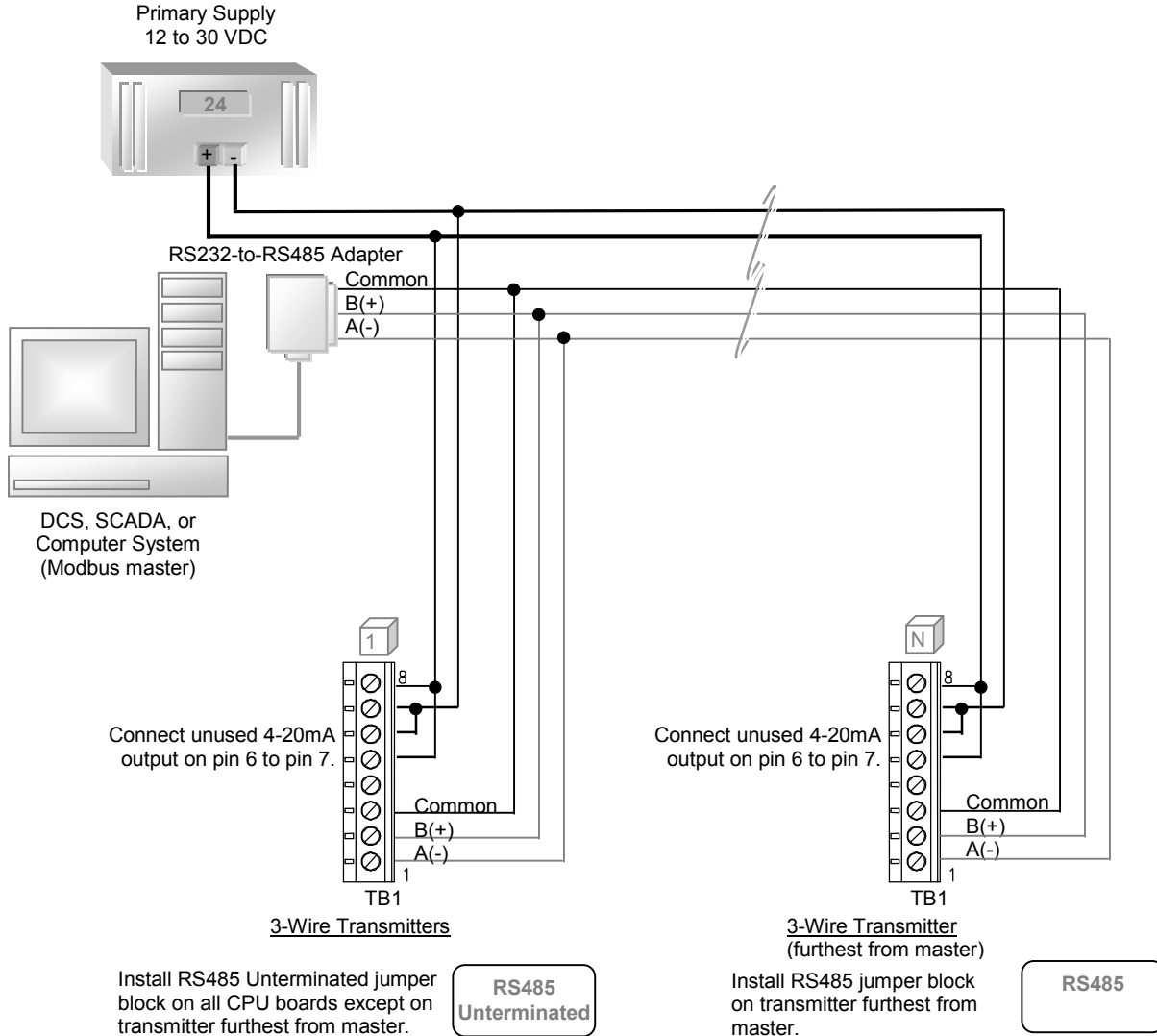

Figure 17. RS485 Modbus Multidrop Example

RS232 Modbus, PC Capture, or Printer

RS232 operation requires the transmitter to be wired in 3- or 4- wire mode. In addition, the RS232 COM jumper must be installed at JP4 on the CPU board. The RS232 connection may be used for a Modbus connection, capturing the data log output using a PC, or printing the data log output to an Epson compatible printer. Refer to the **Modbus Interface Manual** for details on Modbus connections and implementation, and to Appendix A on page 70 for details on outputting data log reports.

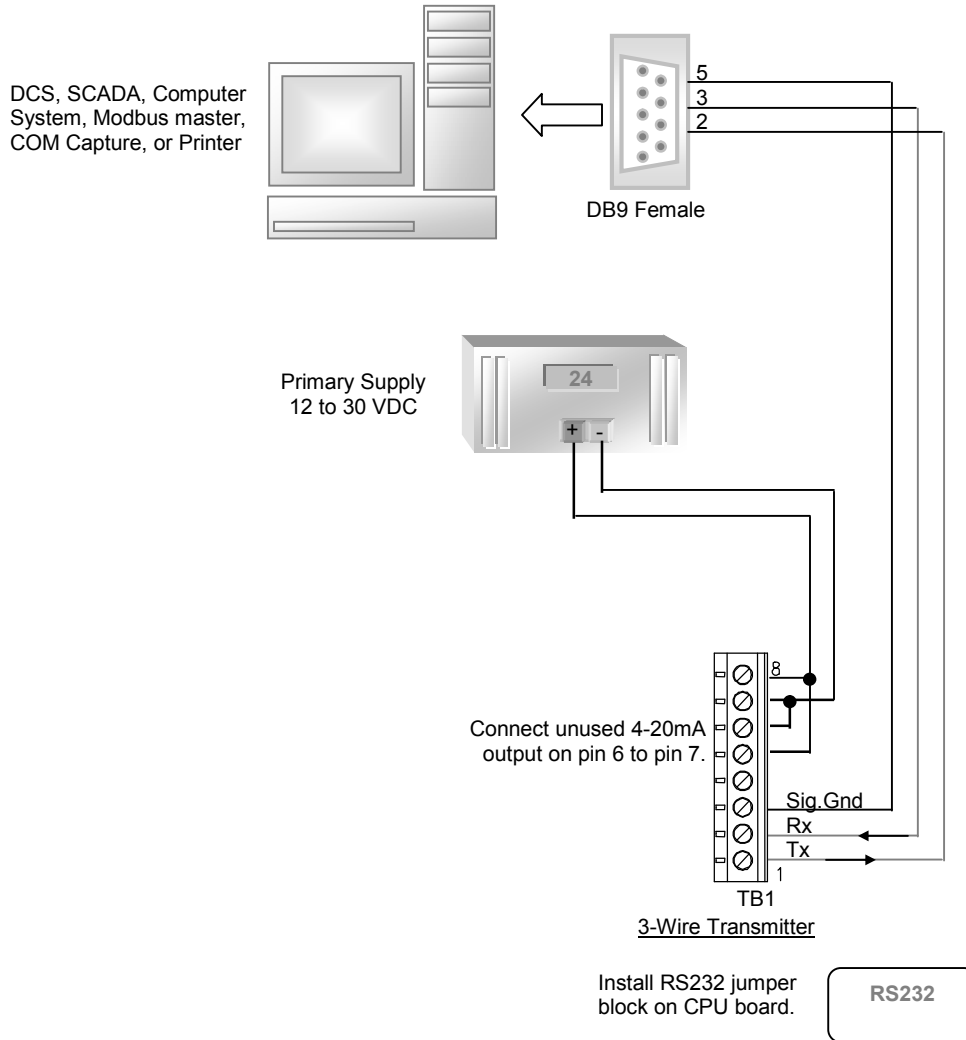

Figure 18. RS232 Modbus, PC Capture, Printer Example

Remote Sensor Wiring

The remote sensor option allows separation of the sensor and transmitter by up to 25 feet. The sensor is threaded into a junction box, and connected to the transmitter using a supplied cable, which may be shortened, if necessary. The figure below shows the wiring connections at each end.

Run wires through metal conduit.

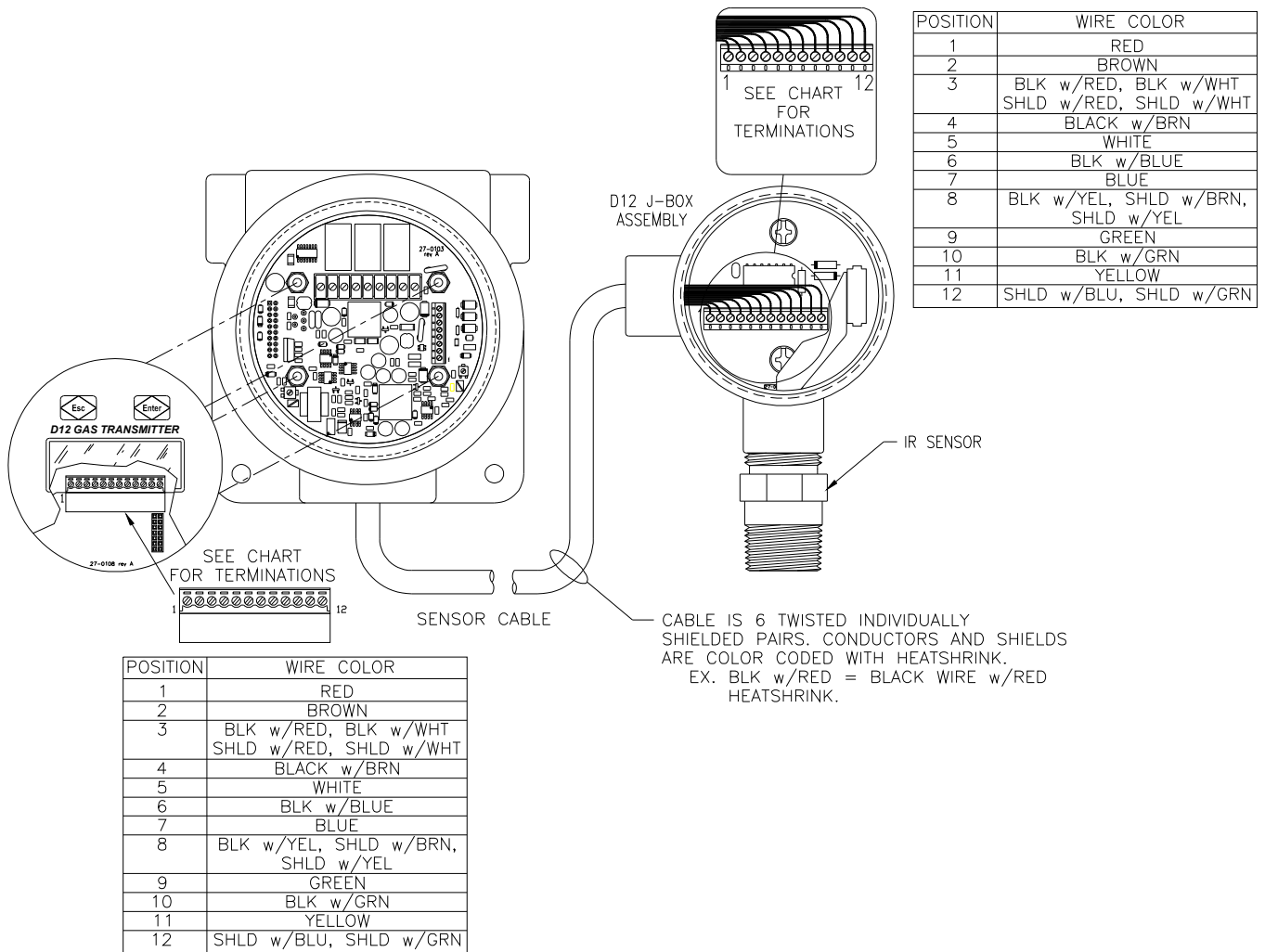

Figure 19. Remote Sensor Option wiring

CPU Board Configuration

If required, install a communications jumper plug on JP4 based on the protocol and interface options shown in Table 9. If equipped with relays, install a jumper on JP1, pins 3-4.

Table 9. Communication option jumpers

Protocol	Interface	Jumper Plug Label	Comments
HART	Bell 202	None Required	Okay to install any.
Modbus	RS232	"RS232"	Use to connect one transmitter to a master device in a "point-to-point" configuration. See "D12 Modbus Manual" for details.
Modbus	RS485	"RS485"	Use to connect up to 4 transmitters to a master device in a "multi-drop" configuration. Each transmitter connection biases and terminates the transmission line, as shown below. See "D12 Modbus Manual" for details.
Modbus	RS485	"RS485 Unterminated"	Use to connect more than 4 transmitters to a master device in a "multi-drop" configuration. Transmitters are connected without adding bias or termination. Install one (terminating) "RS485" jumper plug on transmitter at furthest end of transmission line. See "D12 Modbus Manual" for details.
ASCII	RS232	"RS232"	Use to connect one transmitter to a printer, or system terminal (see Datalogging section).

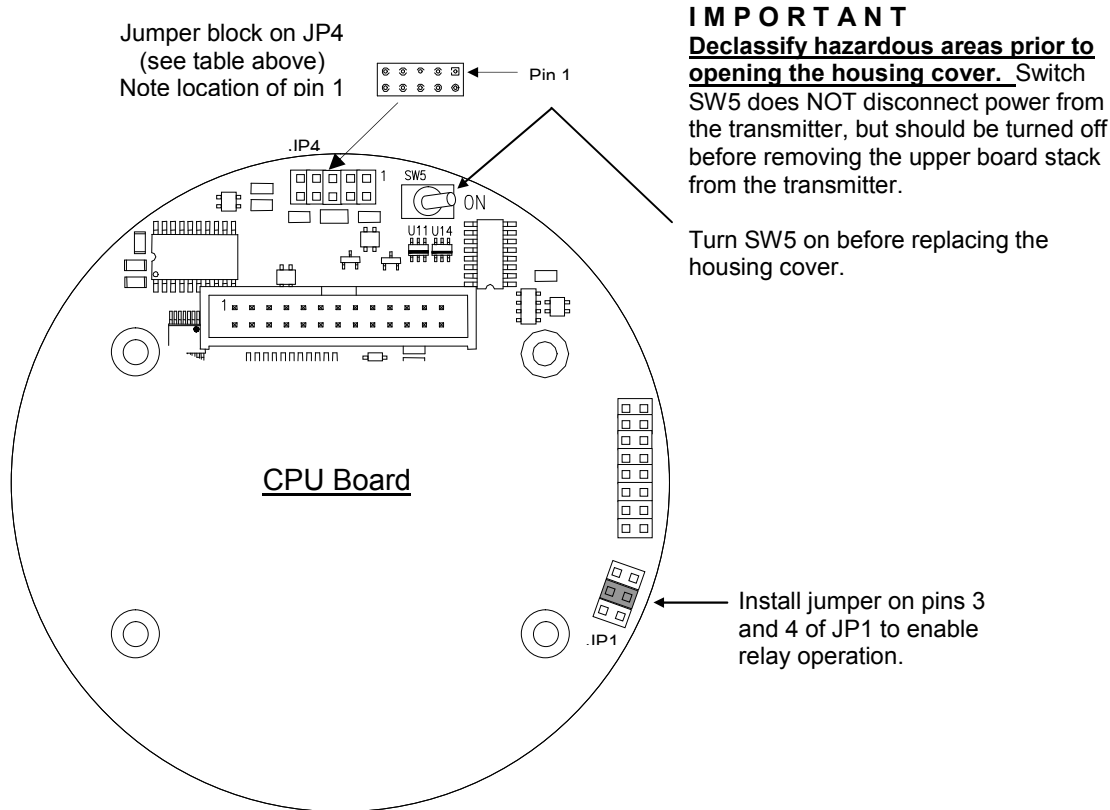

IMPORTANT
Declassify hazardous areas prior to opening the housing cover. Switch SW5 does NOT disconnect power from the transmitter, but should be turned off before removing the upper board stack from the transmitter.

Turn SW5 on before replacing the housing cover.

Figure 20. CPU Board configuration





OPERATION

Interface Panel

The D12 operator interface is non-intrusive, so you do not have to remove the housing cover to view the display, configure the transmitter, or calibrate the sensor. It features a back lighted*, 96x32 dot LCD display, and four “keys”. The keys are implemented as four magnetic switches, each centered below a graphic icon, and activated when a magnet is held approximately 1/4” above the icon. The transmitter is provided with a powerful, magnetic-screwdriver, designed specifically for activating the switches through the housing’s thick, glass window. Throughout this manual, activating keys in this manner is referred to as, “touching” the keys, even though it is not necessary to make physical contact.

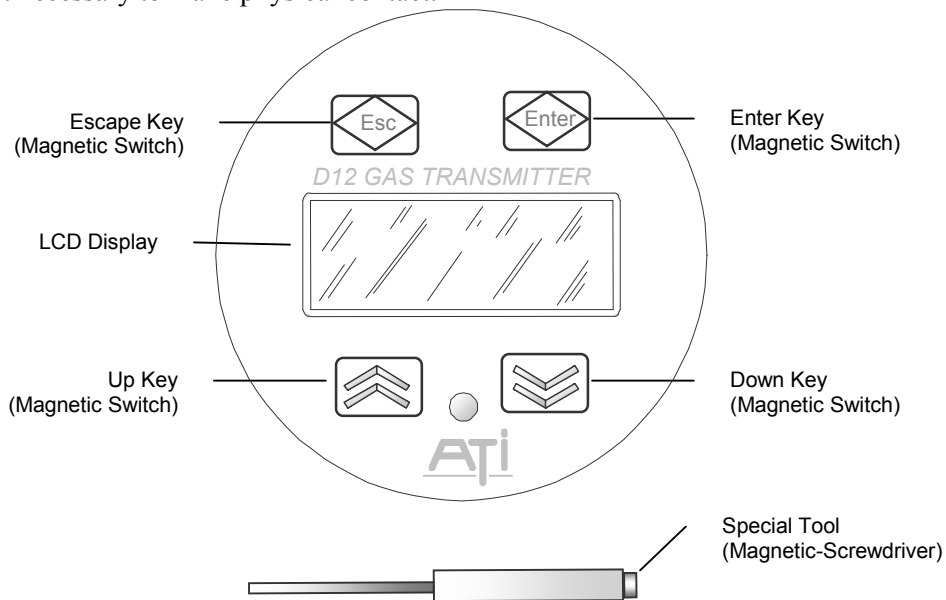

Figure 21. Operatore Interface Panel

The operator interface is organized into pages that consist mostly of text objects representing readings, indicators, variables, functions, and links to other pages. Navigating the pages of objects is simplified through the use of a “point-and-click” interface, using an arrow cursor that may be moved from one object to the next by “touching” the up or down key. While the cursor is “pointing” at an object, touching the magnet to the Enter key is said to “select” the object, and the action performed depends on the type of object. If the object is a function, the Enter key executes the function. If a variable is selected for editing, the Up and Down keys change its value, and the Enter key saves it. Touching the Esc key aborts the edit and restores the previous value. If not executing a function, or editing a variable, touching the Esc key returns to the previous page.

(* back-lighting available in 3- or 4-wire mode, only)

Startup Review Sequence

When the transmitter starts, the display cycles through a series of pages to review the configuration of the transmitter, sensor, and generator. Alarms are inhibited, and the output of the transmitter is held at 4.0 mA. This state is maintained for 5 minutes to provide time for the sensor readings to stabilize.

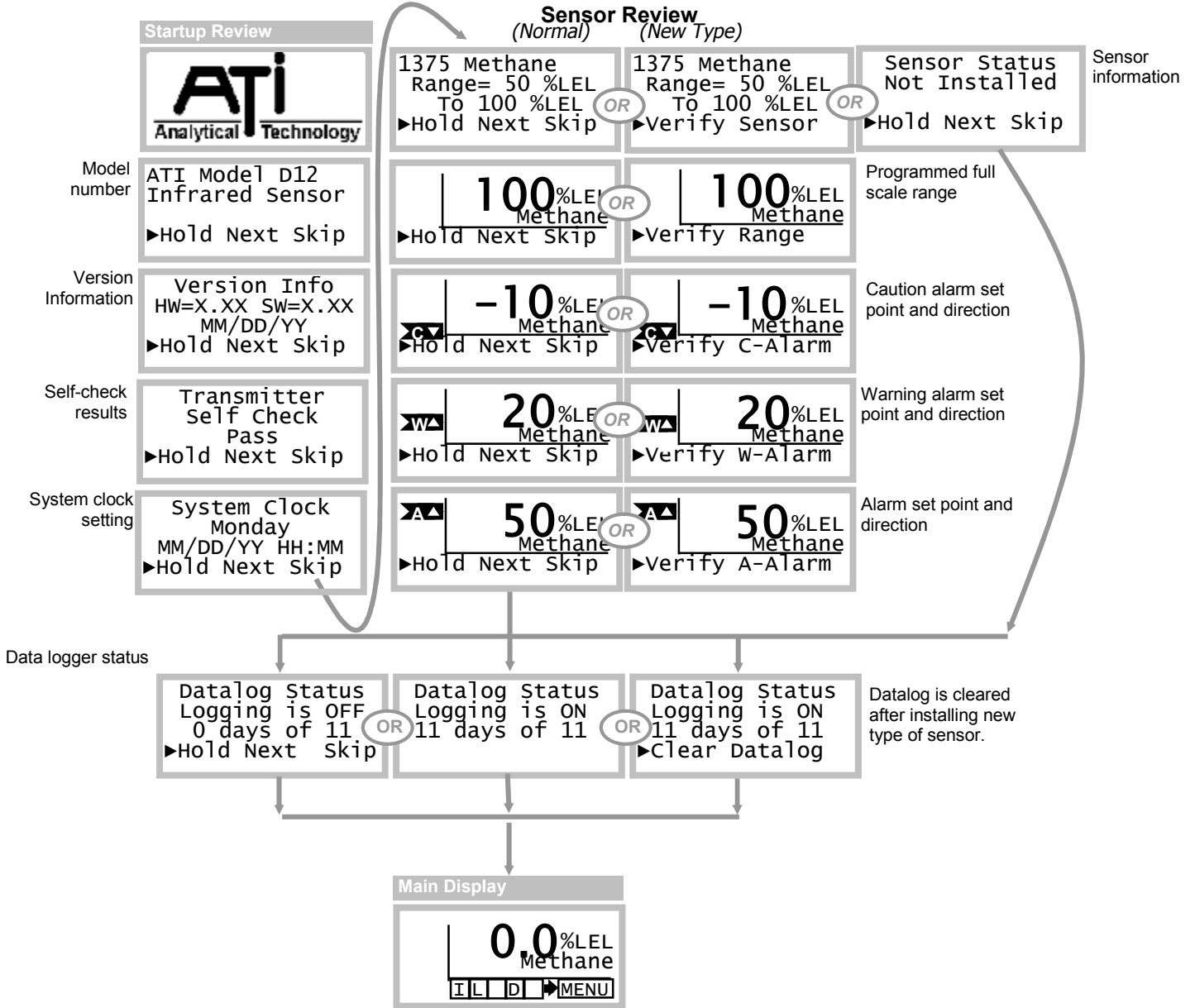

Figure 22. Startup review sequence

Main Display Page

The Main Display Page shows the name and concentration of the target gas, and units of measurement (%LEL, %V/V, PPM, etc). Indicators on the left and below show alarm and operating status.

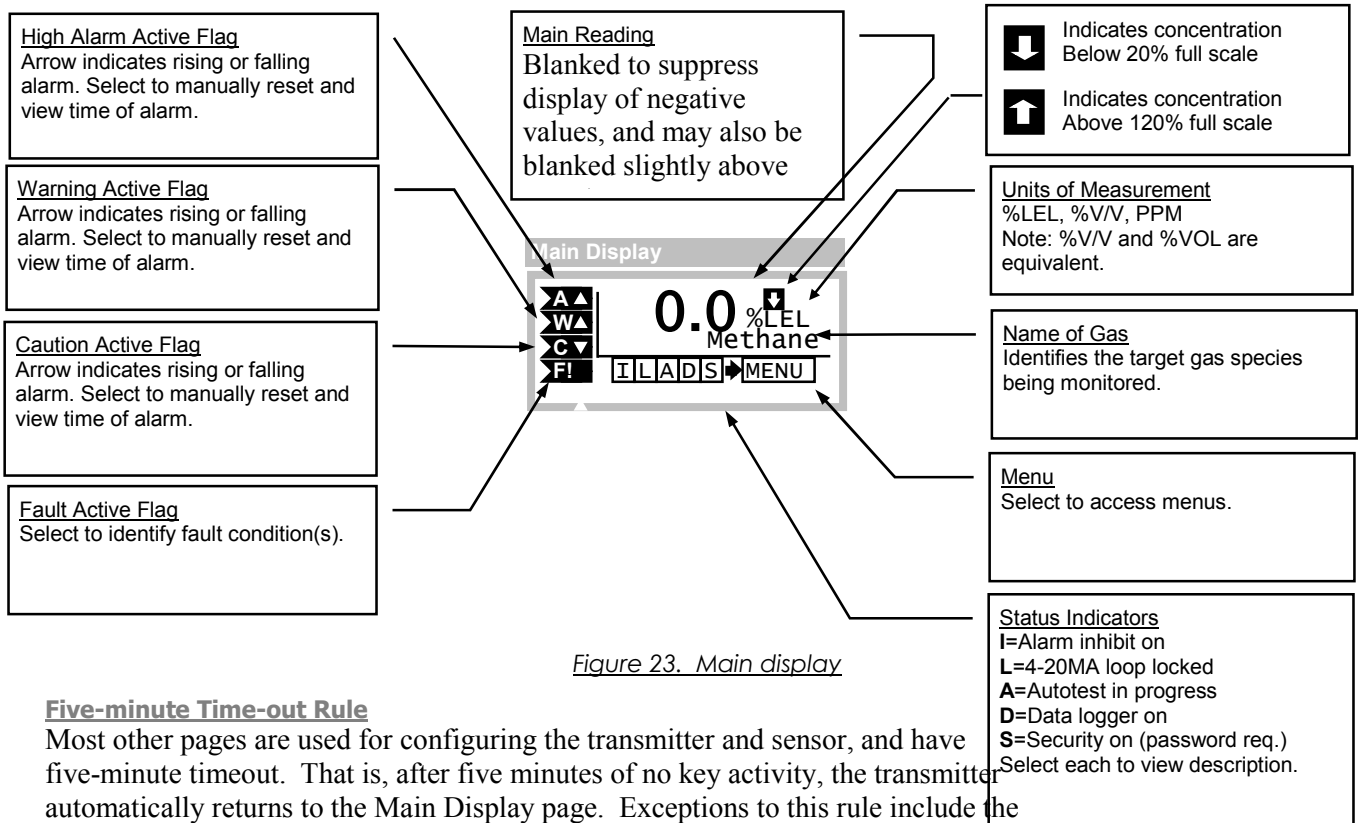
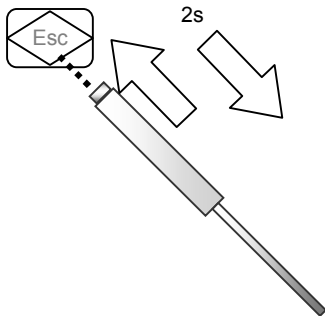

Figure 23. Main display

Five-minute Time-out Rule

Most other pages are used for configuring the transmitter and sensor, and have five-minute timeout. That is, after five minutes of no key activity, the transmitter automatically returns to the Main Display page. Exceptions to this rule include the zero and span calibration pages.



Esc Key Operation - Main Display Only

Holding the magnet over the ESC key for 2 seconds, then removing, toggles alarm inhibit mode on and off. If the alarm inhibit mode was off, it is turned on for 15 minutes (default value). If alarm inhibit was on, it is turned off immediately. Alarm inhibit mode is on when the "I" status indicator is visible.

Fault Indication

Faults are indicated on the Main Display Page as shown below.

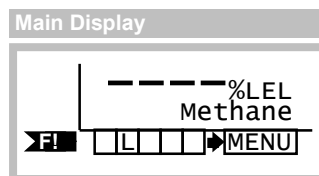

Main Reading

The main reading represents the gas concentration value and appears on the Main Display, along with the sensor name, and units of concentration. It is reported on the 4-20mA output¹, and is the PV (Primary Variable) reported on the optional HART™ interface. It also appears at register 40043 (D12_SYS_CONCBL) on the optional Modbus interface.

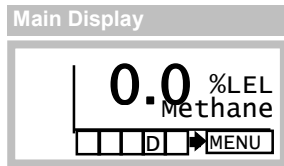

By default, the main reading is blanked to suppress the display of negative values. That is, the reading is reported as zero if the concentration should dip below zero, which can occur over time as a result of sensor aging. If the concentration falls to – 20% of the full-scale range, a fault alarm is generated. Blanking is typically extended slightly above zero, as a means of stabilizing the main reading in the presence of excessive external noise, or other environmental factors (see Sensor Setup Pages).

During zero and span calibration, the “un-blanked” gas concentration value is displayed, primarily to assess the amount of positive or negative drift. The “un-blanked” reading is also available on the Modbus interface (request “D12 Transmitter Modbus Interface Manual”, for more information).

Menu Page

The MENU page provides direct access to the zero and span calibration functions, and to the data log graphics page. It also provides access to the setup page for configuring the transmitter. To access it from the Main Display page, touch the magnet to the up or down key until the cursor is pointing to the **MENU** icon, then touch the Enter key.

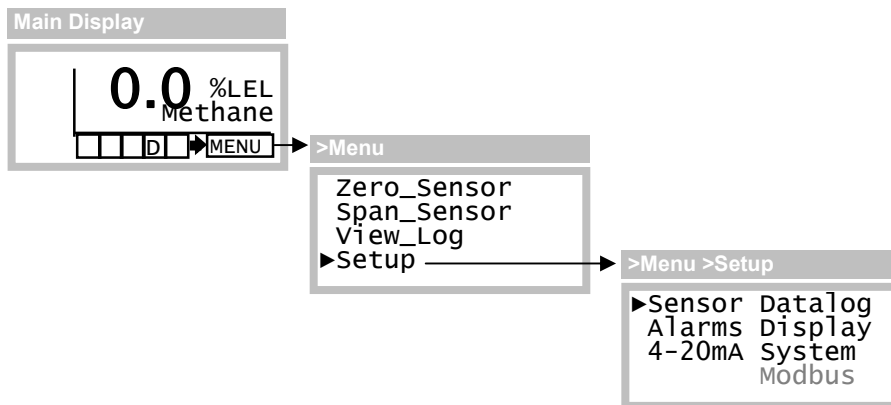

Figure 24. Menu and Setup pages.

Setup Page

The Setup page lists the pages used to configure the operation of the transmitter. The contents of each of these pages are included as part of the description of each function, in the sections that follow.

¹ The 4-20mA may not correspond to the reading when the “L” status indicator is visible on the Main Display, or when the output is in a physical limit.

Variable Editing

When a variable is selected, the edit cursor appears. The shape of the cursor symbolizes the up-down scroll nature of the value being edited. To provide feedback about which key is being activated, the cursor changes to a solid up-arrow when the magnet is touching the Up key, and to a solid down-arrow when the magnet is touching the Down key. When the variable has been adjusted to the desired value, touching the magnet to the Enter key changes the cursor to an hourglass shape while the program is saving the new value (recalculating associated variables and updating non-volatile memories). Touching the magnet to the Esc key discards the edited value and restores the original value.

Cursors

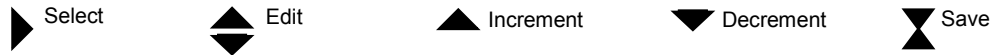

<p>1. On entry, the select cursor points to the first variable for editing.</p>		<p>6. Touch the magnet to the ENTER key to save the edited value, or...</p>
<p>2. Touch the magnet to the UP or DOWN key to move the cursor to the desired item.</p>		<p>7. Touch the magnet to the ESC key to cancel the edit without saving.</p>
<p>3. Touch the magnet to the ENTER key to edit the item, the edit cursor appears.</p>		<p>8. If no key activity is detected for 5 minutes, the transmitter cancels the edit and reverts to normal operation.</p>
<p>4. Touch the magnet to the UP key to increment the value, and the increment cursor appears.</p>		<p>Main Display </p>
<p>5. Touch the magnet to the DOWN key to decrement the value, and the decrement cursor appears.</p>		

Figure 25. Variable editing

² Range is restricted between 100 and 50 when equipped with the HC sensor.

Sensors

The operator interface includes several pages for configuring the sensor, and accessing its calibration history.

Sensor Setup Pages

Sensor Target Gas, Range, Units, and LEL Variables

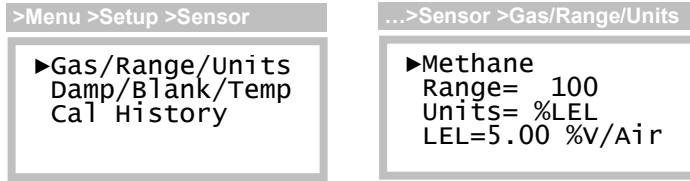

Figure 26. Sensor setup and Gas/Range/Units pages

Table 10. Sensor target gas, range, units, and LEL variables

Variables	Description
Gas Name (line 1)	The name of the target gas appears on line 1. During edit, the setting may be scrolled up and down to select a different gas. Only gasses that have been span calibrated at the factory will appear.
Range	The Range variable sets the full-scale value of the transmitter, which corresponds to the 20mA output value. Changing the range value also changes the Blanking value, which is computed as a fraction of the range. If data logging is enabled, a warning is displayed when the value is changed (see below).
Units	The Units variable affects all concentration readings appearing at the transmitter, and over the Modbus and HART interface. Selections are dependent on the target gas selection, and in some cases, the setting is restricted to only one selection.
LEL	The LEL variable is read only and appears for gasses that may be displayed in units of %LEL (explosive gasses). The displayed value is the volumetric mixture ratio corresponding to 100 %LEL, and is provided to overcome any ambiguity in the %LEL reading.

The data-logger records readings as a fraction of the sensor range. If data logging is turned on (indicated by “D” status indicator on the Main Display), changing the Range variable causes a warning message to appear prior to saving the value. Select “Save” to save the new Range variable, or “Abort” to leave it unchanged.

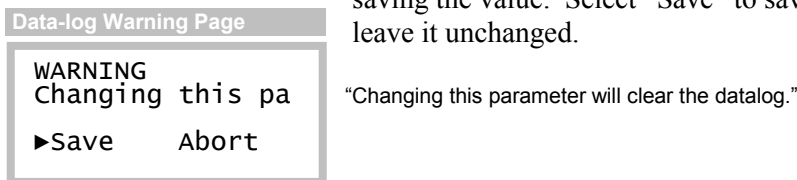

Figure 27. Data-log warning page

Sensor Damping, Blanking, and Temperature Variables

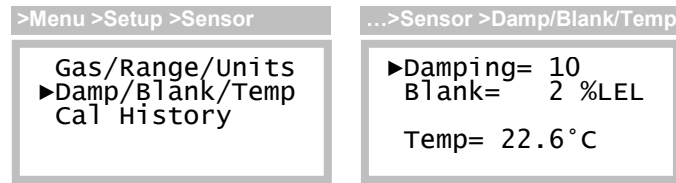

Figure 28. Sensor setup and Damp/Blank/Temp setup page

Table 11. Sensor damping, blanking, and temperature variables.

Variables	Description
Damping	The Damping variable allows minor adjustment of the transmitter’s auto-damping feature, used to stabilize readings. It is a unit-less value from 1 to 100, where a value of 1 corresponds to a T90 ³ response of approximately 20s, and 100 is a T90 of approximately 30s. The default value is 10, resulting in a T90 response of approximately 21s.
Blank	<p>The Blank (blinking) variable is used to force the main reading to zero, whenever the gas concentration is below the programmed value. Blanking is normally limited from 0 to 10 % of Range, but varies by target gas selection. Note that the transmitter always performs negative blanking, even when Blank is set to 0.</p> <p>The Blank variable is recomputed when the Range variable changes, so that same fraction of range is maintained. Doubling, or halving the Range variable, doubles or halves the Blanking variable, respectively.</p>
Temp	The Temp variable displays the sensor temperature in degrees Celsius. Due to the internal heating effect of the sensor, the reading may appear low when the transmitter is initially powered on. Allow at least 30 minutes for the reading to stabilize.

Sensor Cal History (Link)

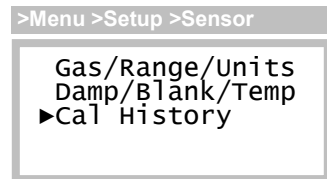

Figure 29. Sensor Cal History

Table 12. Sensor Cal History

Variables	Description
Cal_History	Cal_History is a link to the Calibration History page (see Sensor Calibration Records).

³ T90 is the time required for the transmitter to reach 90% of its final value, after a step change in gas concentration.

Bump-Testing

“Bump-testing” refers to a test whereby the sensor is briefly exposed to gas in order to verify the reading moves upscale from zero. It is recommended that it be performed at least once a month, using a small amount of bottled span gas.

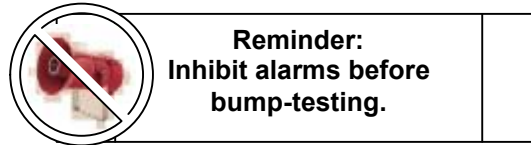

Exposing the sensor to any reactive gas could cause false alarms, and can be avoided by temporarily inhibiting them. The most convenient method for doing so is from the Main Display, using the Esc key. This also allows you to view the transmitter reading to verify the sensor’s response.

To quickly inhibit alarms...

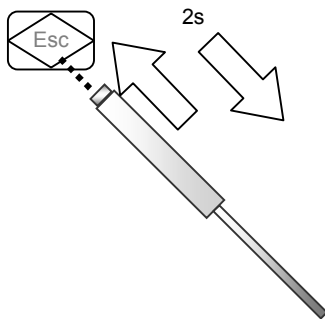

Hold the magnet over the ESC key for 2 seconds, and remove it. This will toggle the alarm inhibit mode on for 15 minutes (default value), hold the current loop at 4mA, and cause the “I” and “L” status indicators to appear. Repeat the procedure when finished with the bump-test, and verify the flags disappear. See “Inhibiting Alarms” for more details.

Calibration

Calibration Frequency

While the D12 transmitter requires no periodic calibration, it is recommended that the IR sensors be zero and span calibrated every 3-6 months. The frequency of calibration may depend on environment factors. Sensors frequently exposed to dirt, oil mist, vapors, or very dry air, may require more frequent calibration.

Calibration Terminology

The zero calibration is referred to as, “zero”, “zeroing”, and “zeroed”. Likewise for the span calibration, which appears as, “span”, “spanning”, and “spanned”. IR sensors have an inherently non-linear response to gas that causes zero errors to magnify span errors. Therefore, zero calibration must be performed before span. Further, an appropriate bottled zero gas source must be used to zero, if span is to be performed.

Zero Calibration

As the name implies, zero calibration corrects the transmitter reading to zero in the absence of any gas that causes a response by the sensor. During zero calibration, the transmitter offset error is stored and subsequently used to normalize readings.

HC and HHC IR sensors may be zero calibrated to the atmosphere under the following conditions.

- a) the atmosphere is known to be free of hydrocarbon gases
- b) the sensor will not be subsequently span calibrated

If either of the above is not true, HC and HHC sensors must be zero calibrated with bottled zero air, or nitrogen (N₂). CO₂ and N₂O IR sensors must always be zero calibrated with bottled nitrogen.

Span Calibration

The role of span calibration is to correct the transmitter reading to a known concentration of target gas. During span calibration, the transmitter stores the response of the sensor and uses it to compute subsequent readings. As mentioned above, zero calibration with a bottled zero gas source must be performed before span.

Calibration Kits

Bottled calibration kits containing calibrated zero and span gases are available from ATI. Contact ATI, or your local ATI representative, if you have questions about calibration gas kits or gas sources.

Indications During Sensor Calibration

The “un-blanked” gas concentration value is displayed during zero and span calibration, primarily to observe any slight amount of positive or negative drift. In addition, alarms are cleared and inhibited, and the 4-20mA output of the D12 transmitter is locked at 4.0mA. The 4-20mA output will not change when gas is applied and removed, and for 15 minutes thereafter (the default value). While viewing the calibration pages, the LCD display will indicate the changing gas concentration.

Calibration Exceptions

Zero and span calibration are not allowed during the following conditions:

- ❖ transmitter is in the 5-minute⁴ warm-up period
- ❖ a transmitter fault is active

To help prevent calibration errors, zero and span are not allowed if the sensor output, or span value entered, is too high or too low.

Zero Calibration with a Zero Gas Source

In addition to the bottled zero gas source, you will need a 500 cc/min regulator, calibration adapter, and a convenient length of 1/4" tubing. Referring to Figure 30, screw the calibration adapter onto the exposed end of the sensor and connect one end of the tubing (1), connect the other end of tubing to the cylinder's regulator (2). Do not open the gas valve until instructed and skip to the Zero Sensor Page below.

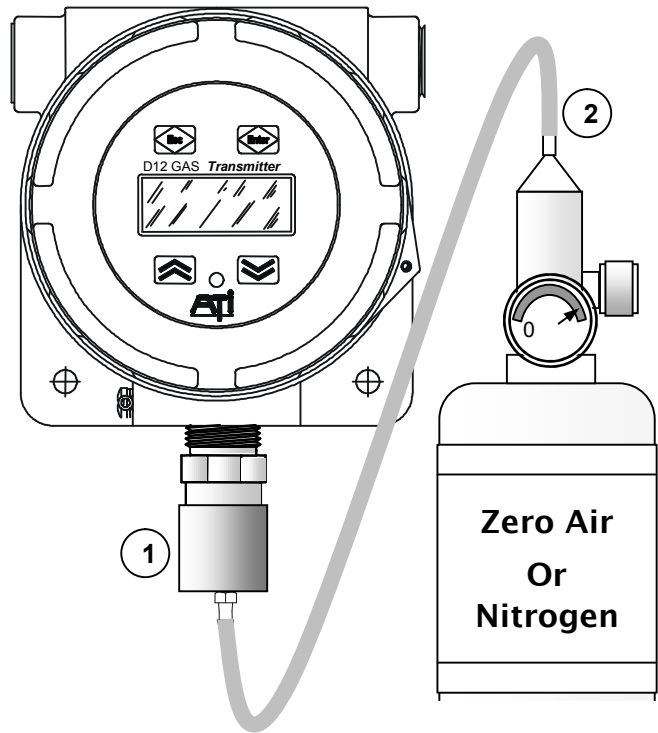

Zeroing to the Atmosphere

This procedure is permitted only for HC and HHC IR sensors, providing that:

- a) the atmosphere is known to be free of hydrocarbon gasses, and,
- b) span calibration will not be subsequently performed

Continue with the Zero Sensor Page below.

Figure 30. Zero calibration

Zero Sensor Page

From the Main Display, select Menu, then Zero_Sensor, as shown in

Figure 31. This will clear and inhibit alarms at the transmitter, and hold the current loop output at 4mA.

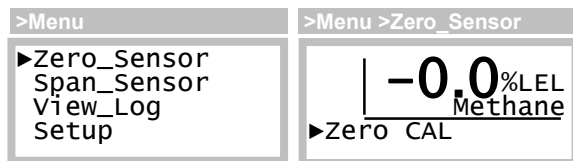

Figure 31. Zero Sensor page

Open the regulator to flow gas to the sensor. After approximately four minutes, select Zero. The “Cal” message will appear at the bottom of the page and remain while the transmitter adjusts its input amplifier circuitry. When finished with the adjustment, the reading will be forced to 0. Since the reading is not blanked, it may show a negative indication, like “-0”, which is normal.

Touch the Escape key twice to leave the Zero_Sensor page and return to the Main page. By default, alarms will remain inhibited, and the current loop fixed for 15 more minutes (the default value).

Span Calibration Procedure

Span calibration* requires a cylinder of “span” gas with a 500 cc/min regulator, calibration adapter, and a convenient length of ¼” tubing. Referring to

Figure 32, screw the calibration adapter onto the exposed end of the sensor and connect one end of the tubing (1) to it, connect the other end of tubing to the cylinder’s regulator (2). Do not open the gas valve until instructed below.

* Perform the Zero calibration prior to the Span calibration.

From the Main Display, select Menu, then Span_Sensor, as shown in Figure 33. This will clear and inhibit alarms at the transmitter, and hold the current loop output at 4mA.

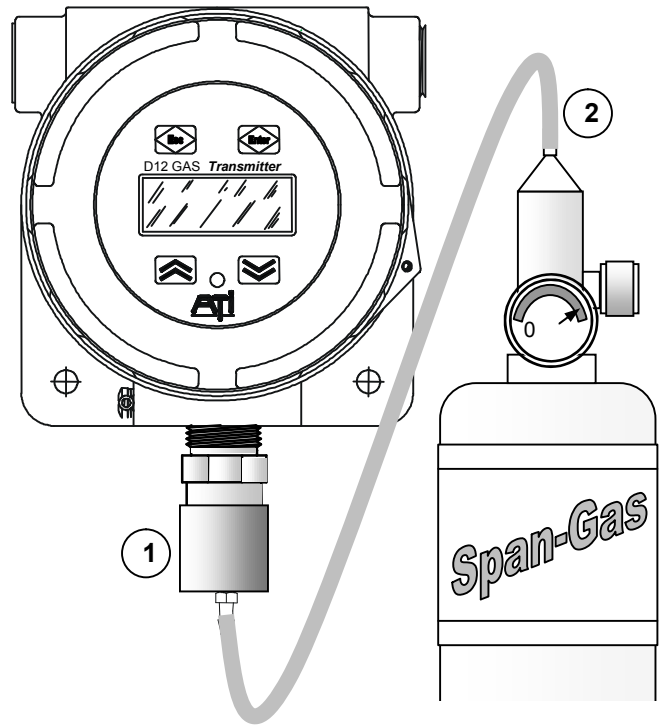

Figure 32 Span calibration

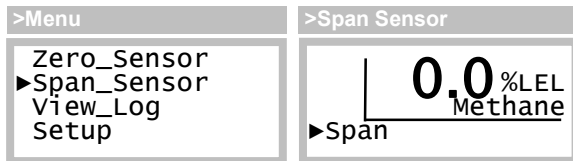
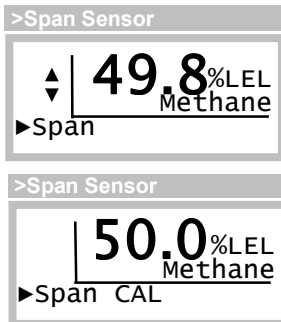

Figure 33. Span_Sensor page

Open the regulator and allow span gas to flow to the sensor. Observe the displayed reading begins to increase, and at the end of four minutes, the reading should be stable.



Select Span, the concentration reading will become fixed, and the blinking Up/Dn edit cursor will appear just to the left of the reading. Touch the Up or Down key to correct the reading to match the known concentration of gas, then touch Enter.

The ‘Cal’ message will appear briefly at the bottom of the page. The procedure may be cancelled by selecting Undo. The Undo function is only possible while remaining on the Span_Sensor page. Leaving the page will disable the possibility of canceling the span calibration.

Touch the Escape key twice to leave the Span_Sensor page and return to the Main page. Disconnect the calibration adapter from the sensor and permit the readings to return to zero. By default, alarms will remain inhibited and the current loop fixed for 15 more minutes (the default value). Once the reading is below any of the alarm set points, you may terminate the alarm inhibit (and fixed loop output) using the Esc key on the Main Display (see Esc Key Operation - Main Display in the Main Display Page section).



Spanning for Safety – HC and HHC IR Sensors

It is usually best to avoid situations where the HC or HHC IR sensor may be exposed to more than one combustible gas at the same time, due to differences in LEL and sensitivity. In situations where it cannot be avoided, calibrate the sensor to the gas exhibiting the lowest sensitivity at its corresponding LEL. This will provide the highest margin of safety. Although a false alarm may result if a leak develops by one of the other gases, this strategy safeguards against potentially explosive conditions developing at the sensor location. Contact the factory for information about the sensitivity of IR sensors.

Sensor Calibration Records

A calibration record is written into the sensor memory each time a zero or span calibration is performed. Enough memory is reserved for 63 zero calibrations and 63 span calibrations. After that, new calibration records overwrite older ones (ie, 64 replaces 1, 65 replaces 2, and so on). Zero and span calibration records are accessed from the Cal_History page as shown below.

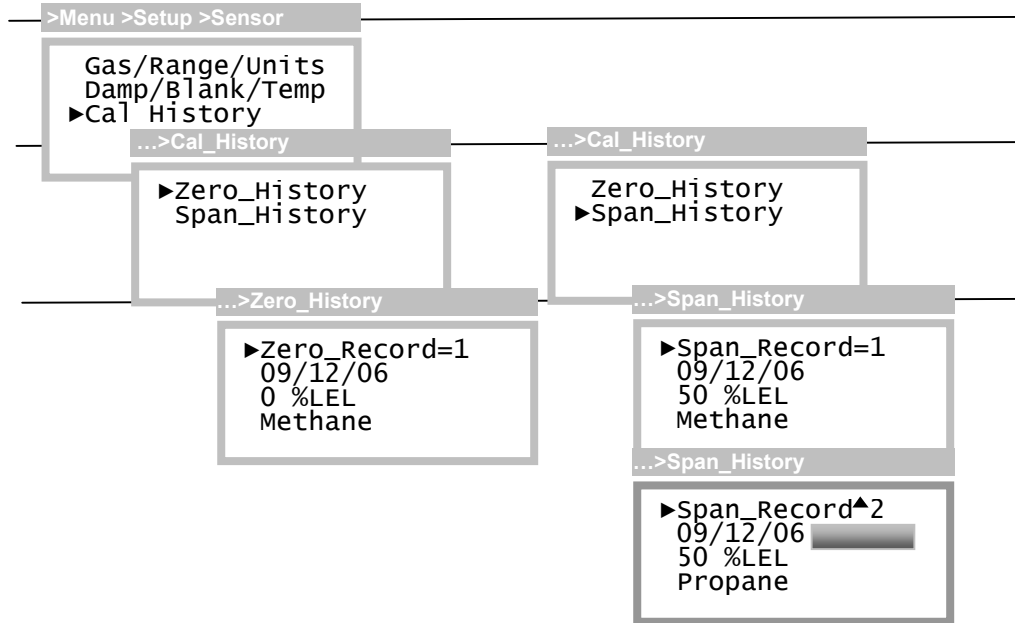

Figure 34. Sensor calibration history pages

Zero calibration records are accessed in the Zero_History menu and include the index, date, and concentration reading just prior to calibration. The concentration reading is displayed in the currently programmed units, and can be thought of as the sensor “drift” from the previous zero calibration. The target gas at the time of the calibration is also displayed. Upon entry, the index number is set to the most recent calibration and may be scrolled down to view earlier calibration records.

Span calibration records are accessed in the Span_History menu and include the index, date, and concentration of span gas used during calibration, in the currently programmed units. The target gas at the time of the calibration is also displayed. If the gas was used to calibrate a group of other gasses, the word “Group” appears as shown. Like the zero records, the index number is set to index the most recent calibration and may be scrolled down to view earlier calibration records.

ALARMS and RELAYS

The standard D12 transmitter features three gas alarms, and one fault alarm. The alarm status indicators appear on the Main Display, and status is available over the optional Modbus® or HART® serial interface. Alarms may be assigned to activate one or more of the three optional relays, which are discussed below in Alarm Relays.

Gas Concentration Alarms

The gas alarms are labeled, Caution, Warning, and Alarm. Although not strictly enforced, Alarm usually has the highest priority, followed by Warning and Caution. Figure 35 depicts the default relationship between the alarms.

For combustible gasses, no alarm may be set higher than 60 %LEL. The default setting for the Warning alarm is 20 %LEL, and 50%LEL for Alarm. Caution is used to alarm on negative drift of -10 %LEL or more (a fault alarm occurs if the reading drifts to -20 %LEL, or below).

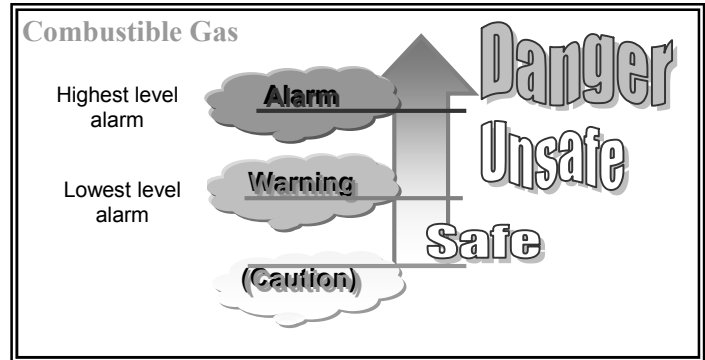

Figure 35. Default alarms for combustible gas sensors.

Manual Alarm Reset

Alarms programmed for manual reset (see below) are held active, or latched, even after alarm conditions have subsided. On the combustible sensor version of the transmitter, Alarm is always programmed for manual reset. Latched alarms are reset from the Main Display page by selecting the respective flag (A, W, or C). The Alarm Reset page appears and displays the date and time of the alarm. If alarm conditions have subsided, you may reset just the selected alarm (Reset), or all alarms (ResetAll). A link to the Alarm Inhibit page is provided for convenience.

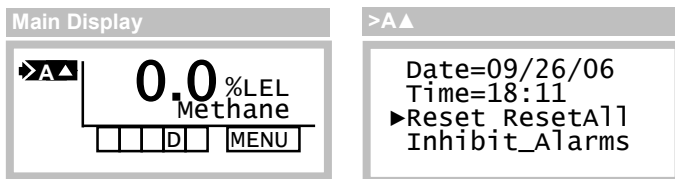

Figure 36. Manual alarm reset

Remote Reset

Grounding the “Remote Reset” input resets all latched alarms, if the respective alarm conditions have subsided (see Figure 9. Power supply board connections.).

Gas Alarm Setup Pages

Variables for the gas alarms are configured on the respective setup pages, as shown in Figure 37, and described in Table 13.

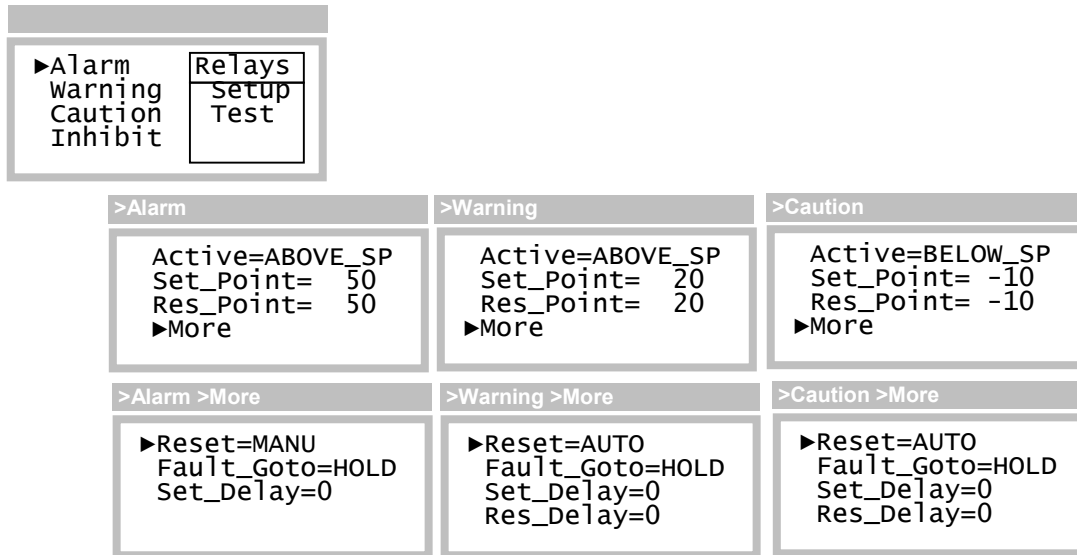

Figure 37. Alarm setup pages (example)

Table 13. Alarm variables

Variable	Description
Active	The Active variable is used to specify the concentration range where the alarm is active. When set to ABOVE_SP, the alarm becomes active at and above the set point (referred to as a rising alarm). When set to BELOW_SP, the alarm becomes active at and below the set point (referred to a falling alarm). Setting the value to DISABLED permanently deactivates the alarm. The variable setting is stored in the transmitter memory.
Set_Point	The Set_Point variable defines the concentration level that the alarm becomes active. The alarm becomes active immediately if the set delay variable is 0, otherwise, it becomes active at the expiration of the set delay period. When the set point is reprogrammed, the reset point value is also reprogrammed to the same value.
Res_Point	The Res_Point variable defines the concentration level that the alarm becomes inactive. Once the alarm is active, it will remain active until the concentration level reaches the reset point. The alarm then becomes inactive immediately if the set delay variable is 0, otherwise, the alarm becomes inactive at the expiration of the reset delay period (only if the reset variable is programmed as AUTO – see below). The limits for the reset point are defined below. Active=ABOVE_SP Upper limit = current set point value Lower limit = lowest set point value Active=BELOW_SP Upper limit = highest set point value Lower limit = current set point value When the set point is reprogrammed, the reset point value is reprogrammed to the same value.



Reset The Reset variable defines how the alarm is permitted to transition from active, to inactive. When the variable is set to AUTO, the alarm will transition without operator intervention, as soon as conditions permit (concentration reaches the reset point, and the reset delay period expires). When the variable is set to MANU, the reset conditions must prevail, and an operator must acknowledge the alarm manually, through the operator interface, the serial interface, or through the remote reset (see Electrical Connections, page 16). On the combustible sensor version of the transmitter, Alarm is restricted to MANU only.

Note: Res_Delay is operational for AUTO only. Setting the Reset variable to MANU suppresses display of the Res_Delay variable.

Fault_Goto The Fault_Goto variable specifies alarm behavior during transmitter faults, and overrides all other alarm settings. If the fault alarm should become active, you may program the concentration alarm to behave in one of three ways:
HOLD - the transmitter will attempt to hold the alarm in its current state. If the alarm is active, it will remain active. If the alarm is inactive, it will be inhibited from becoming active until after the fault is cleared.
SET - activates the alarm immediately, the set delay period is ignored. This feature permits the alarm to signal both concentration and fault conditions.
RESET – deactivates the alarm immediately, the reset delay period is ignored.

Set_Delay The set delay variable is used to configure the amount of time in seconds that the concentration must be in the alarm active region before becoming active. It may be used to avoid triggering alarms on relatively short gas exposures. Also, it may be used to help prevent alarm relay chattering when the concentration level is varying between the set point and reset point. The variable may be programmed between 0 (its default) and 10 seconds.

Res_Delay The reset delay variable is only displayed when the Reset variable is set to AUTO. It is used to configure the amount of time in seconds that the concentration must be in the alarm inactive region before becoming inactive. Like the set delay variable, it may be used to help prevent alarm relay chattering and is preferred over using set delay. The variable may be programmed between 0 (its default) and two hours (7200 seconds).

Alarm Variable Functions

Figure 38 depicts relationships between variables associated with a rising gas alarm, and how they function in the presence of a gas leak, and recovery.

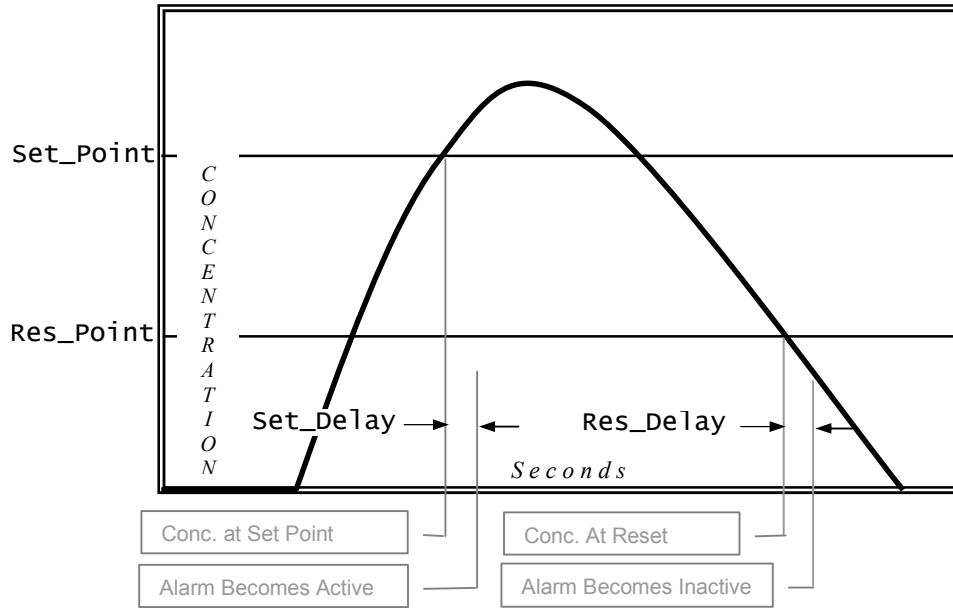

Figure 38. Rising alarm (Active=ABOVE SP, Reset=AUTO)

Figure 39 depicts relationships between variables associated with a falling gas alarm (such as for Oxygen deficiency), and how they function in the presence of a gas displacement, and recovery.

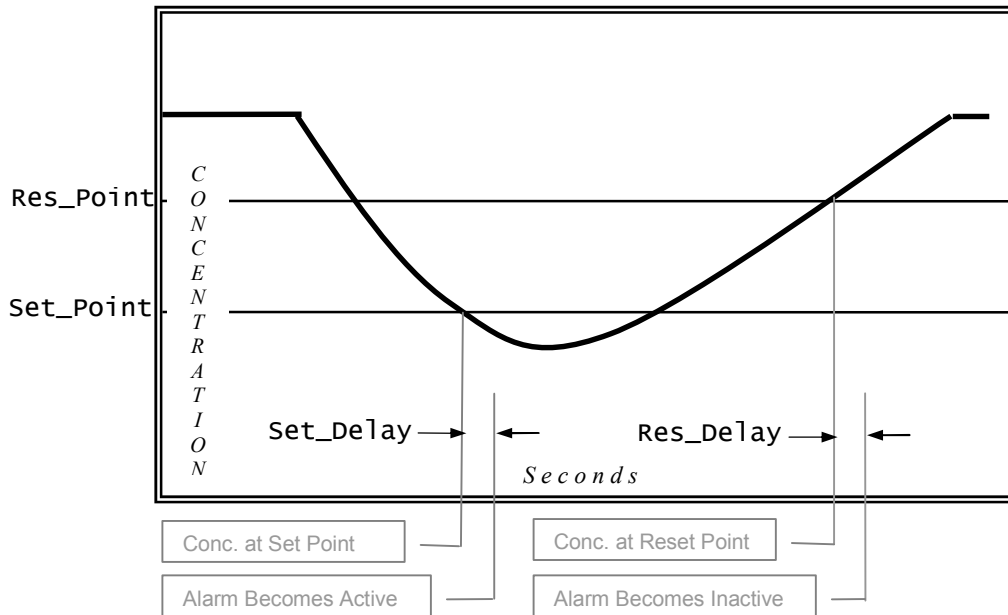

Figure 39. Falling alarm (Active=BELOW SP, Reset=AUTO)

Fault Alarms

When a fault alarm occurs, the Main Display appears as shown below. By default, new alarms are inhibited, and active alarms are held so that relays controlling lights, sirens, and fans may continue to operate (this behavior may be modified on the Alarms Setup pages). Faults are permitted to clear automatically, without operator intervention, if they do not persist.

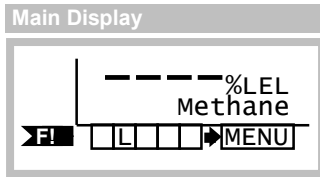

Figure 40. Fault alarm (Main Display)

Selecting the fault alarm flag causes the transmitter to display the fault code on line 1, and a description of the problem(s) on line 2. Selecting the Next function causes line 2 to display the next fault, if any.

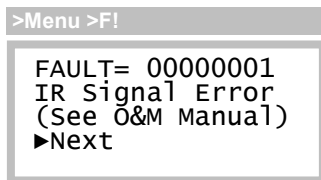

Figure 41. Fault page

Corrective Actions

Improper wiring, ground loops, power supply sizing, current loop receivers, and other external factors may cause transmitter faults.

1. At power on, transmitters can demand 2 or 3 times the normal amount of supply current. If the supply is not sized properly, transmitters may not power on, or may produce a fault in the external power supply. If this is suspected, try starting transmitters one at a time using switch SW5 on the CPU Board.
2. Check that each transmitter has the proper supply voltage at TB1 on its Power Supply Board. The D12 Combustible Gas Transmitter requires at least 10v in all wiring modes.
3. When troubleshooting, it is permissible to temporarily swap sensors, generators, and board stacks with other transmitters. When finished, you MUST RE-VERIFY all transmitter settings, especially sensor, alarm, and 4-20mA settings. Also note that swapping components may result in losing data log records, since the log is dependent on sensor part numbers, and the full-scale range.

Table 14 lists transmitter faults and corrective actions that should be attempted in the order shown. Remember to maintain safety when attempting to diagnose or perform corrective actions.



Never enter an area, and never open a transmitter, without first making sure it is safe to do so.

Table 14. Fault descriptions

Bit No.	Fault	Description	Corrective Action(s)
0	IR Signal Error	One or both of the IR sensor signal inputs have failed, or are out of limits. This may indicate a wiring or environmental problem, or an actual failure of the sensor or transmitter hardware.	<ol style="list-style-type: none"> 1. Cycle power 2. Re-zero the sensor 3. If remote, check sensor wiring 4. Replace upper stack 5. Replace sensor 6. Replace lower stack
1	LCD Busy Error	The LCD driver chip cannot recover from an internal error.	<ol style="list-style-type: none"> 1. Cycle power 2. Replace upper stack 3. Replace lower stack
2	SPI Bus Error	Serial peripheral interface bus has faulted.	<ol style="list-style-type: none"> 1. Cycle power 2. Replace upper stack 3. Replace lower stack
3	ADC1 Read Error	The sensor's temperature signal is out of limits, or the analog-to-digital converter channel assigned to it has failed.	<ol style="list-style-type: none"> 1. Cycle power 2. Replace upper stack 3. Replace sensor 4. Replace lower stack
4	Sensor (-)Range	The sensor has drifted -20% range (below zero).	<ol style="list-style-type: none"> 1. Zero sensor 2. Replace sensor 3. Replace upper stack 4. Replace lower stack
5	Sensor Removed	The sensor cannot be detected. This appears when the transmitter cannot detect the sensor's temperature input signal.	<ol style="list-style-type: none"> 1. Cycle power 2. Reconnect sensor 3. Replace sensor 4. Replace upper stack 5. Replace lower stack
6	Sensor Mem Error	One or more configuration variables in the sensor memory failed checksum.	<ol style="list-style-type: none"> 1. Cycle power 2. If remote, check sensor wiring 3. Replace sensor 4. Replace upper stack

7	Sensor Cfg Error	One or more sensor configuration variables are outside of expected range.	<ol style="list-style-type: none"> 1. Cycle power 2. Replace sensor 3. Replace upper stack
8	Gas Gen Removed	Not applicable to IR sensors.	
9	Gen Incompatible	Not applicable to IR sensors	
10	System Mem Error	A checksum error has been detected in the system (hardware) setup memory.	<ol style="list-style-type: none"> 1. Cycle power 2. Replace upper stack 3. Replace lower stack
11	Alarm Mem Error	A checksum error has been detected in the alarm setup memory.	<ol style="list-style-type: none"> 1. Cycle power 2. Replace upper stack 3. Replace lower stack
12	Operator Mem Err	A checksum error has been detected in the operator setup memory.	<ol style="list-style-type: none"> 1. Cycle power 2. Replace upper stack 3. Replace lower stack
13	HART Mem Error	A checksum error has been detected in the HART setup memory.	<ol style="list-style-type: none"> 1. Cycle power 2. Replace upper stack 3. Replace lower stack
14	Autotest Failed	Not applicable to IR sensors.	
15	Use 3-wire Power	Not applicable to IR sensors (always powered in 3- or 4-wire mode)	
16	UNCALIBRATED	This appears on the Main Display, in place of the gas name, when the transmitter has not been factory calibrated, or the calibration memory has become corrupted.	<ol style="list-style-type: none"> 1. Cycle power 2. Replace upper stack 3. Replace lower stack
17	Stack Overflow	An internal error occurred in the CPU program or data stack.	<ol style="list-style-type: none"> 1. Cycle power 2. Replace upper stack
18	Fault Alarm Test	Fault alarm is being tested locally, or remotely (not a fault).	No action required.
19	Not Used		
20	Factory Cal Err	An error has been detected in the factory calibration memory.	<ol style="list-style-type: none"> 1. Cycle power 2. Replace upper stack

Alarm Relays

The D12 transmitter provides three optional SPDT mechanical relays rated for 5 amps, non-inductive loads at 250VAC. These relays are suitable for switching small loads, such as horns and warning lights, but should not be used to switch motors or other high current, inductive loads.

Each relay is assigned to one of the four alarms, and may be programmed as normally energized (failsafe), or normally de-energized. A normally energized relay will have electrical continuity between its C and NO contacts (while the transmitter is powered on), and will be open between its C and NC contacts. Conversely, a normally de-energized relay will have continuity between its C and NC contacts, and will be open between its C and NO contacts. Figure 42 illustrates the function of alarm and relay variables on the operation of the relays.

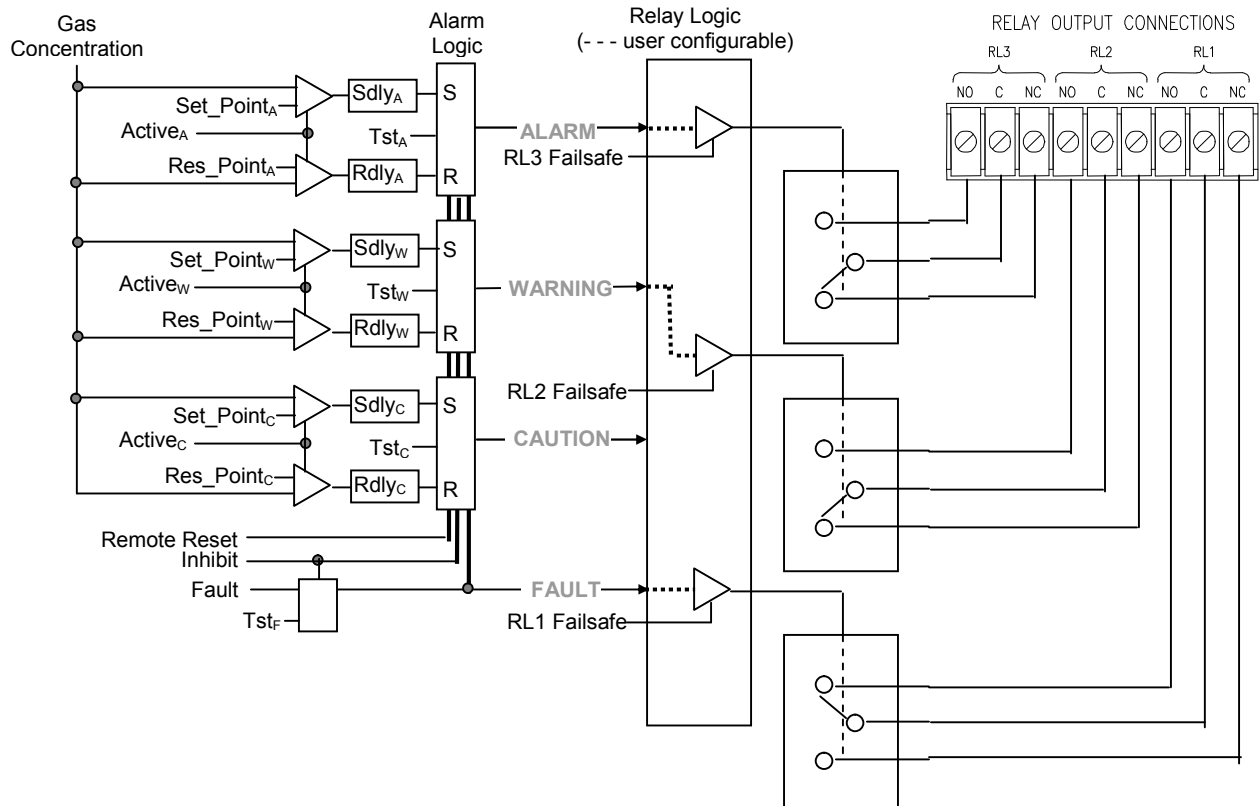

*Figure 42 Alarm relay schematic
(default configuration – no alarms active)*

Relay Setup Page

Relays are configured in the Relays Setup page, which is accessed by selecting Menu, Setup, Alarms, and (Relays) Setup. Select the alarm trigger source (Alarm, Warning, Caution, Fault), and failsafe property (Normal-On or Normal-Off).

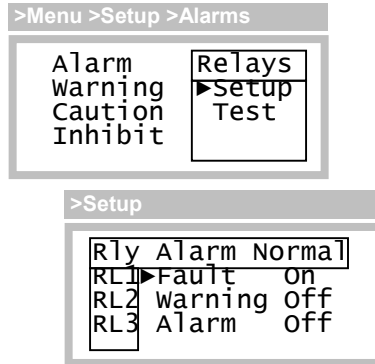



Figure 43. Relay setup page (example)

Testing Alarm Relays

Relays are tested by triggering (simulating) their assigned alarms on the Relay Test page. To trigger an alarm, scroll the “Select” variable up and down until an X appears below the letter representing the alarm. Save the selection by touching the Enter key, and move the cursor to the function labeled “Start”.

	<p>Caution: devices wired to the relays may activate when “Start” is selected. Be sure to inform proper personnel before performing the test.</p>	
--	----------------------------------------------------------------------------------------------------------------------------------------------------------	---------------------------------------------------------------------------------------

When ready, select “Start” to begin the test. “Start” will be replaced by, “Any key to Stop”, and touching any key will end the test.

Relay Test Page

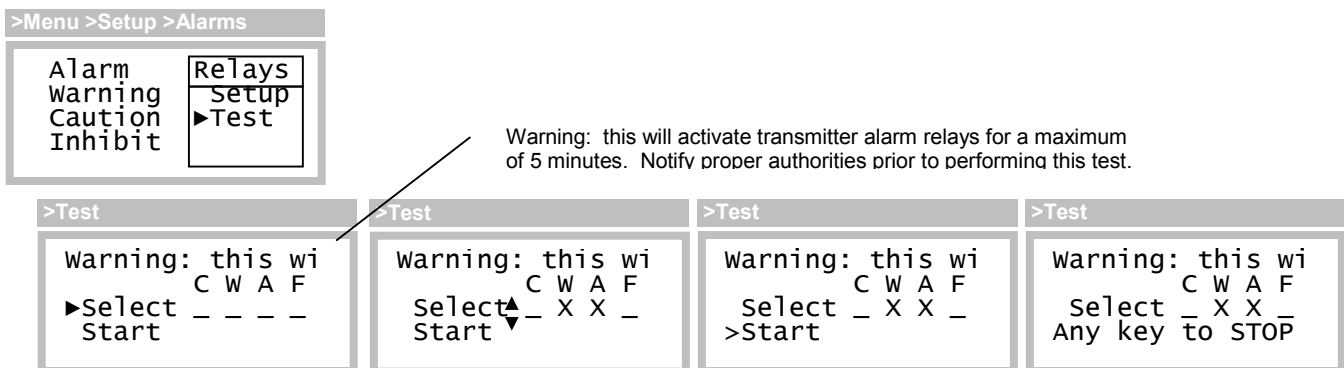

Figure 44. Relay test page example

Inhibiting Alarms

Alarms should be inhibited to prevent false activation, such as done just prior to “bump-testing” the sensor.

The most convenient method for temporarily inhibiting alarms is from the Main Display. Hold the magnet over the ESC key for 2 seconds, and remove it. This will toggle the alarm inhibit mode on for 15 minutes, which will clear and inhibit alarms, hold the current loop at 4mA, and cause the “I” and “L” status indicators to appear. Repeating the procedure toggles alarm inhibit mode off immediately, restores the current loop to normal operation, and clears the “I” and “L” status indicators. Both the inhibit duration, and loop output, are programmable and may be accessed on the Alarm Inhibit setup page (see below).

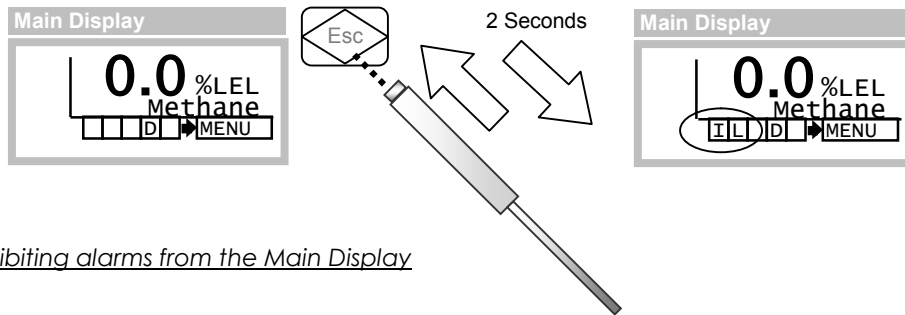

Figure 45. Inhibiting alarms from the Main Display

Alarm Inhibit Setup page

Variables and controls associated with the alarm inhibit mode are accessible on the Alarm Inhibit setup page (below), and are detailed in Table 15.

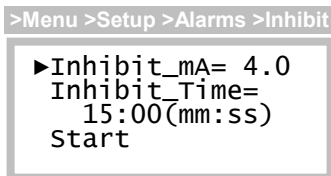

Figure 46. Alarm inhibit setup page

Table 15. Alarm inhibit variables and controls

Variables	Description
Inhibit_mA	The Inhibit_mA variable is output on the current loop during alarm inhibit. It ranges from 3.5 to 22.0 mA (this is the same value that appears on the 4-20mA Setup page).
Inhibit_Time	<p>Alarm Inhibit Off</p> <p>The Inhibit_Time variable is the duration of the alarm inhibit mode, and is programmable from 00:00 to 99:59 (mm:ss).</p> <p>Alarm Inhibit On:</p> <p>The variable counts down from its programmed duration. Selecting it temporarily freezes the count and permits it to be scrolled up and down. If Enter is touched, counting resumes from the new value. If Esc is touched, counting resumes at the previous value. These changes are temporary, and are not saved as the programmed value.</p>
Start (Stop)	The Start function turns on alarm inhibit, which clears and inhibits alarms, holds the current loop at 4mA, causes the “I” and “L” status indicators to appear, and starts the Inhibit_Time variable to begin ticking down. The label then changes to “Stop”, and selecting it again turns off alarm inhibit, restore the current loop to normal operation, clears the “I” and “L” status indicators, and restores the Inhibit_Time variable to its programmed value.

4-20mA Analog Output

The 4-20mA output normally sources positive current to a receiver, proportional to the main reading. The output is 4 mA at zero, and rises 20mA at the full-scale range (see “Range” variable in Sensor Target Gas, Range, Units, LEL Variables), and may go as high as 24mA (125%LEL) in case of gas flooding. Since reading is blanked below zero, the output never go below 4mA in the course of normal operation.

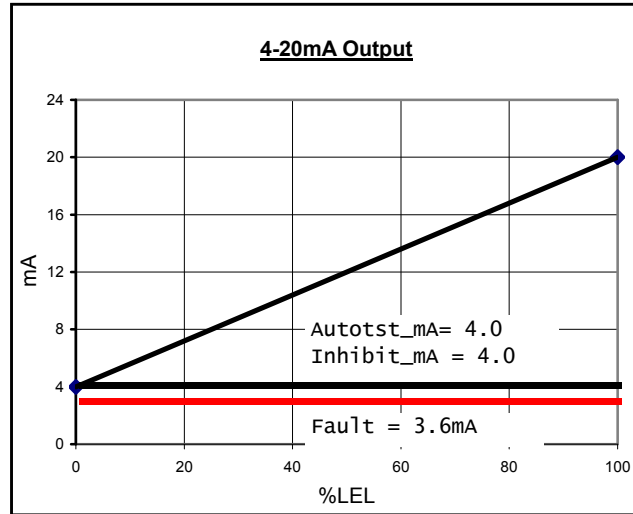

to
and
the
should

Figure 47. Current loop output plot

Output Overrides

By default, the output is forced to 3.6mA to signal fault alarms to the receiver. During alarm inhibit and auto-test modes, the loop is fixed at 4.0mA to prevent false alarms at the receiver. These are the default values, which may be changed on the 4-20mA Setup page.

4-20mA Setup Page

Variables listed on this page are described below.

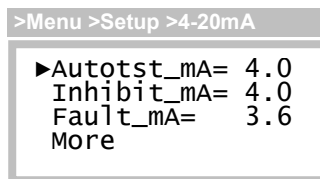

Figure 48. 4-20mA setup page

Table 16. 4-20mA variables

Variables	Description
Autotst_mA	The Autotst_mA variable is the mA value output during Auto-test mode – to prevent false alarms at the receiver. The default is 4.0mA, and is limited between 3.5 ⁵ and 22.0 mA.
Inhibit_mA	The Inhibit_mA variable is the mA value output during the Alarm Inhibit mode – to prevent false alarms at the receiver. The default is 4.0, and is limited between 3.5 ² and 22.0 mA.
Fault_mA	The Fault_mA variable is the mA value output during Fault alarms. The default is 3.6mA, and is limited between 3.5mA ² and 22.0mA. The value should be recognized as a fault by the loop receiver.
More	More is a link to the 4-20mA control page.

⁵ Since the transmitter may be powered from the current loop, 3.5mA is the lower limit for all settings.

4-20mA Control Page

The 4-20mA Control page permits adjustment of the analog output, and provides a method for manually forcing it to a fixed value to overcome leakages, verify linearity, or test receiver alarms.

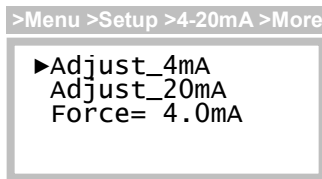

Figure 49. 4-20mA control page

Table 17. 4-20mA control variables

Variables	Description
Adjust_4mA	The Adjust_4mA variable is used to adjust the 4mA level on the 4-20mA output.
Adjust_20mA	The Adjust_20mA variable is used to adjust the 20mA level on the 4-20mA output.
Force	The Force variable is used to force the 4-20mA output to a fixed value. While the variable is not selected, the displayed value is updated to show the real-time output level. The loop is fixed at the instant the variable is selected, and the value may be scrolled up and down as desired, between 3.5 and 22.0 mA.

Loop Adjustment

Loop adjustment consists of adjusting the 4 and 20 mA levels (order does not matter) by scrolling the corresponding DAC⁶ value. This may be accomplished by reading a current meter connected across the mA(+) and mA(-) terminals of TBI on the transmitter’s Power Supply Board, or reading the display of a calibrated, current loop receiver.

Warning:
Disable current loop receiver alarms before proceeding.

Select Adjust_4mA or Adjust_20mA and observe the following displays. Select DAC_Value and scroll the displayed value up and down to achieve the desired output level, and touch Enter to save, or Esc to exit without saving.

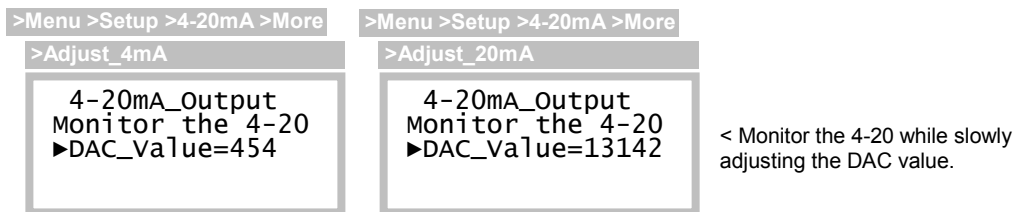

Figure 50. Loop adjustment pages
 (DAC values shown may not match)

⁶ Digital-to-Analog-Converter value ranging 0 to 16383 (14-bits). Adjustment is performed at factory, values will vary from transmitter to transmitter. This range may increase on future versions.

Data Logger

The D12 transmitter data logger records gas concentration in one of 12 discrete intervals ranging from 1 to 60 minutes, providing data from 11 to 474 days. Table 18 details sampling intervals and the associated metrics.

Table 18. Data-log sampling metrics

Sampling (Minutes)	Samples/Day	Days
1	1440	11
2	720	22
3	480	32
4	360	43
5	288	54
6	240	64
10	144	104
12	120	124
15	96	152
20	72	196
30	48	278
60	24	474

Gas concentration (see

Main Reading) is recorded as an instantaneous value, and is not averaged or filtered in any way. When the data log memory is filled, new records will overwrite older ones.

Data-log Access Page

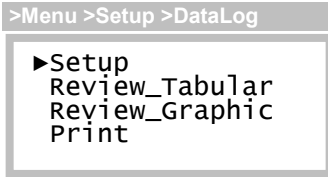

The Data Log Access page provides links to pages described below.

Figure 51. Data log access page

Data-log Setup Page

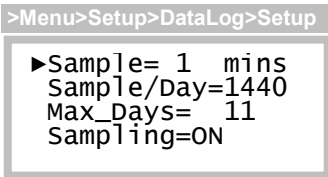

The Data Log Setup page provides variables used to select one of the 12 discrete sampling intervals listed in Table 18, and a control for starting and stopping data-logging, and clearing the data log.

Figure 52. Data log setup page

Table 19. Data-log setup variables

Variables	Description
Sample, Sample/Day, Max_Days	These variables are used to select one of the 12 sampling intervals listed in Table 18. Each variable functions identically. Scrolling any one of the variables updates the other two. Warning: changing the sampling interval will clear the data-log.
Sampling	The Sampling variable is used to control data recording, which starts when set to ON, and stops when set to OFF. The data-log is cleared when set to CLR, after which the control is returned to its previous value (ON or OFF).

Data may be displayed on the LCD graphically, or in a tabular report format. Data may also be output to a terminal, terminal program, or serial printer. Dates formats are configurable as MM/DD or DDMMM (see System Clock), and samples are displayed in the concentration units shown on the Main Display Page.

In place of numeric data samples, a report may display special text to indicate samples were unavailable, not yet sampled, or some condition prevented sampling.

Table 20. Data log special text

Special Text	Description
----	Sample unavailable (transmitter powered off, or sample not yet recorded)
FFFF	Fault alarm active at time of sample
TEST	Auto-test active at time of sample (not applicable on IR sensor versions)
CLNR	Auto-clean option active at time of sample (Wet-H ₂ S sensor, only)
****	Data is corrupted, or unreliable

Data-log Graphic Report Page

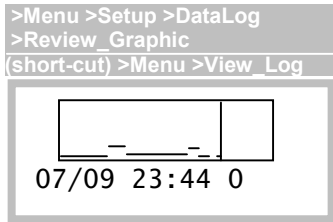

The Graphic Report page plots samples on the LCD from left to right, where older samples are on the left, and newer samples are to the right. Touching the Up and Down keys moves the vertical cursor line right and left, respectively, while updating the date, time, and sample data text on the bottom line.

Figure 53. Data log graphic report page

Upon entry, the cursor is parked at the most recent sample. Moving the cursor left displays the date, time, and values of earlier samples (moving it right will show “- - -”, not sampled yet). Touching the Enter key switches to the Tabular Report page, shown in Figure 54, and touching the Esc key returns to the Menu page. Data is not plotted while viewing the page.

Data-log Tabular Report Page

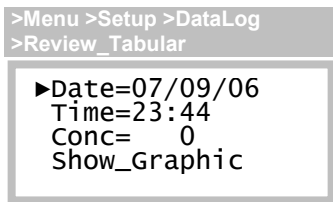

The Tabular Report page displays samples in the text field labeled “Conc”(gas concentration) and provides direct access to data by scrolling to an exact date and time.

Figure 54. Data log tabular report page

Upon entry, the Date, Time, and Conc variables are set to the most recent sample. Scrolling the Time variable up increments it by the sampling interval, and causes the next, successive sample to be displayed at Conc. Scrolling Time down displays the previous sample time, and value. Scrolling Time up and down will cause a date rollover at midnight. Scrolling the Date variable up increments it by one day, while holding the Time variable fixed. This is an expedient method to access specific data, and is useful for examining samples recorded at the time of day.

Once the date and time are set, select the Show_Graphic link to switch to the Graphic Report page. Data is not updated while viewing the page.

Data-log Printout

Data-log reports may be sent to serial printer, terminal, or terminal emulation program, such as Microsoft Hyperterminal®. See Appendix A. details on how to setup print reports.

Date	Time	S0	S1	S2	S3
07/09/06	22:40	1	0	0	1
07/09/06	22:44	-0	0	0	-0
07/09/06	22:48	1	TEST	TEST	TEST
07/09/06	22:52	TEST	TEST	TEST	TEST
07/09/06	22:56	TEST	TEST	TEST	TEST
07/09/06	23:00	1	0	0	1
07/09/06	23:04	1	0	0	1
07/09/06	23:08	1	0	0	1
07/09/06	23:12	1	0	0	1
07/09/06	23:16	1	1	1	0
07/09/06	23:20	0	0	0	-0
07/09/06	23:24	-0	0	0	0
07/09/06	23:28	----	----	----	----
07/09/06	23:32	----	----	----	----
07/09/06	23:36	----	----	----	----
07/09/06	23:40	FFFF	FFFF	0	0

and

Figure 55. Data-log printout

Display

The D12 Transmitter features a back-lighted, 96w x 32h graphics LCD.

Display Setup Page

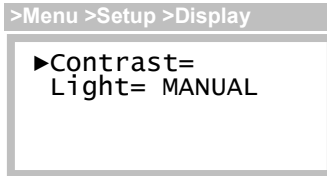

The Display Setup page variables are used to control the display contrast, and manage the backlight.

Table 21. Display page variables

Variables	Description										
Contrast	The Contrast variable is used to adjust the LCD contrast. Scroll the variable up to increase contrast (darker text), or down to decrease it (lighter text). The default value is 68%, and is adjustable between 0 and 100%.										
Light	The Light variable is used to control when the LCD backlighting is turned on and off.										
	<table border="1"> <thead> <tr> <th>Setting</th> <th>Backlight is ...</th> </tr> </thead> <tbody> <tr> <td>MANUAL</td> <td>On when any key is touched Off when no key touched for 5 minutes</td> </tr> <tr> <td>AUTO</td> <td>On when any key is touched or alarm is active Off when no key touched for 5 minutes, and no alarms active</td> </tr> <tr> <td>NEVER_ON</td> <td>Off permanently</td> </tr> <tr> <td>ALWAYS_ON</td> <td>On permanently (not recommended)</td> </tr> </tbody> </table>	Setting	Backlight is ...	MANUAL	On when any key is touched Off when no key touched for 5 minutes	AUTO	On when any key is touched or alarm is active Off when no key touched for 5 minutes, and no alarms active	NEVER_ON	Off permanently	ALWAYS_ON	On permanently (not recommended)
Setting	Backlight is ...										
MANUAL	On when any key is touched Off when no key touched for 5 minutes										
AUTO	On when any key is touched or alarm is active Off when no key touched for 5 minutes, and no alarms active										
NEVER_ON	Off permanently										
ALWAYS_ON	On permanently (not recommended)										

System

System pages provide version information and configure the internal clock, security access, communication protocols, and to reset various memory defaults.

System Access Page

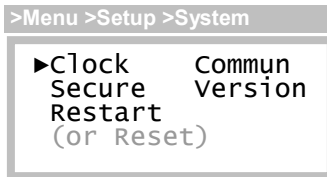

The System Access page provides links to the clock, security, communications, and version pages (the Reset link has been replaced with the Restart function on transmitters beginning with version 2.23).

Figure 56. System access page

Real-time Clock

Clock Setup Page

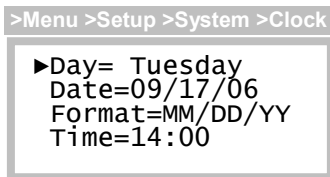

The Clock Setup page is used to set the transmitters real-time clock, which is referenced during sensor calibrations and data logging, and used to trigger Auto-test.

Figure 57. Clock setup page

Variables	Description
Day	Monday, Tuesday, Wednesday, Thursday, Friday, Saturday, and Sunday
Date	Used to configure the month, date, and year, in the format specified by the Format variable (below). Built-in support for leap year.
Format	Selects the date format: MM/DD/YY, example: 09/19/06 DDMMMYY, example: 09Sep06
Time	24-hour format, 00:00 to 23:59

Security

The transmitter protects its configuration using a 4-digit, numeric password, from 0000 to 9999. When security is active, the “S” status indicator appears on the Main Display, variables may be read, but not modified, and functions will not execute, including the sensor verification function during startup review.

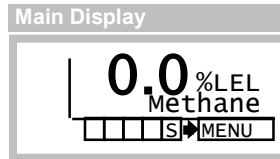

Security Control Page

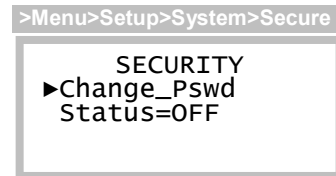

Security is off by default, and may be toggled on and off by entering the 4-digit password.

Figure 58. Security control page

Activating Security

Select the Status variable on the Security Control page, which doubles as a link to the Password Entry page. When the page appears, select Enter Pswd, scroll to the password value (0 by default), and touch Enter. If successful, “PASS” appears briefly and you are returned to the Security Control page where the Status variable is set to ON. If not successful, “FAIL” appears and Status remains OFF.

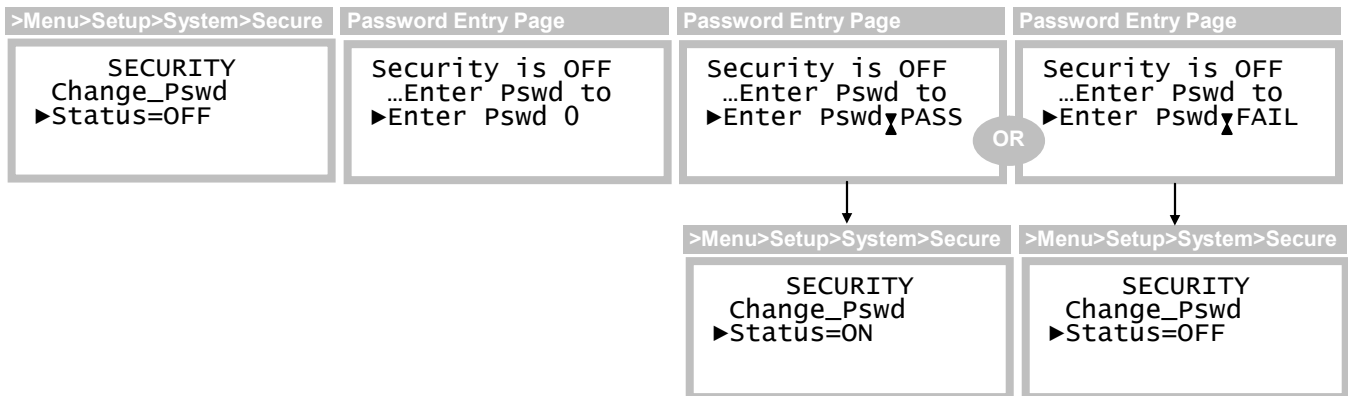

Figure 59. Activating security

Deactivating Security

The procedure to deactivate security is identical to that used for activating it, and if successful, the transmitter presents an option to automatically reactivate it after a timed interval.

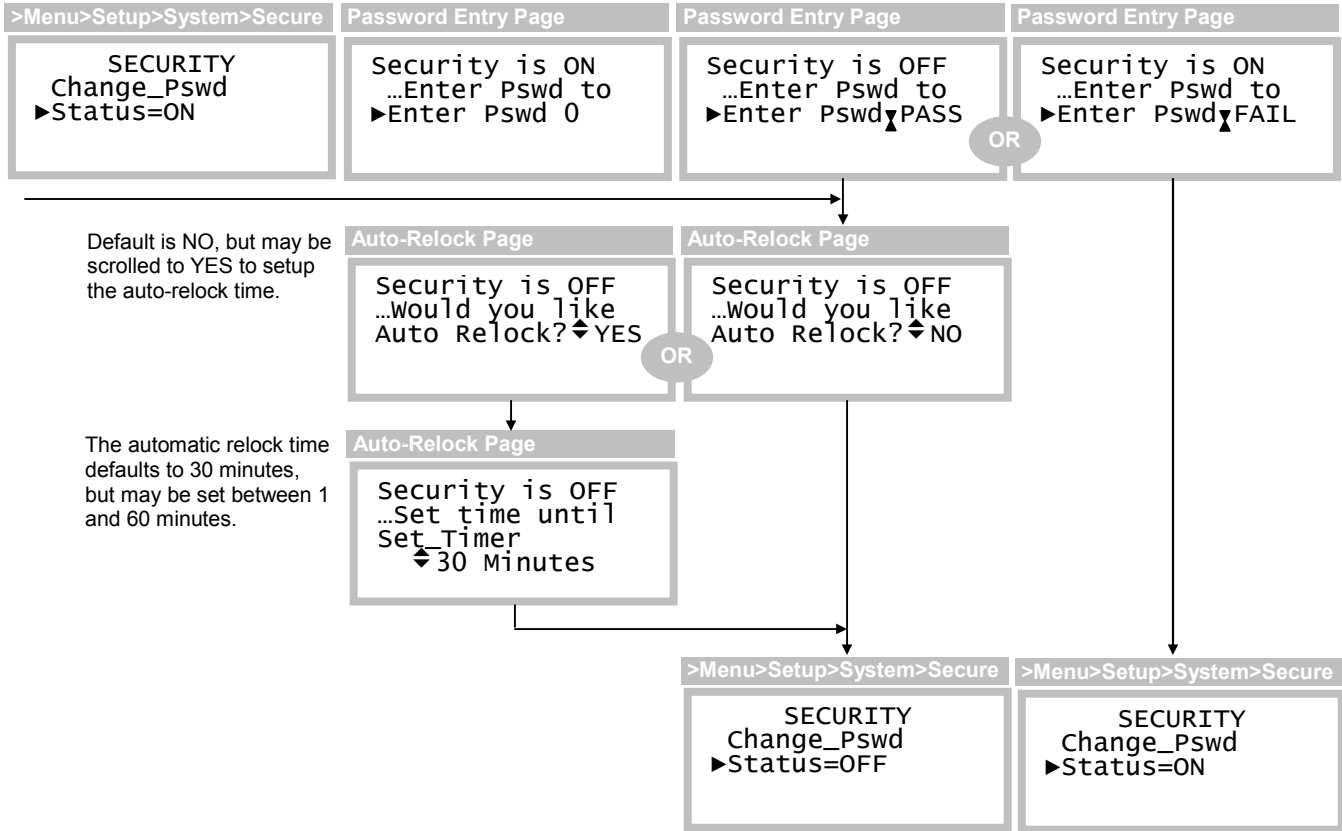

Figure 60. Deactivating security

Changing the Password

The security password is changed by selecting Change_Pswd from the Security Control page. Start by entering the old password, then enter the new one, and repeat it.

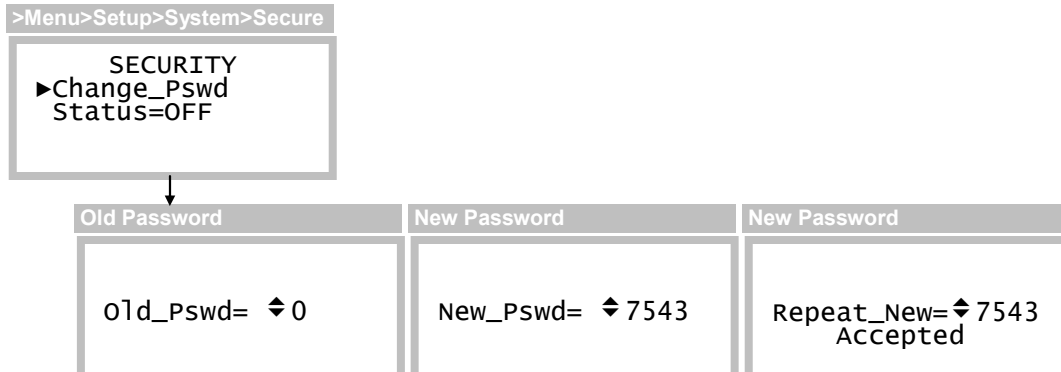
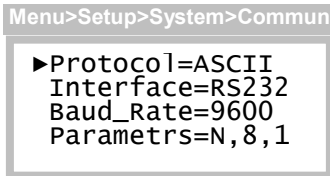

Figure 61. Changing the password

Communications

The D12 Transmitter supports ASCII, HART 5, and Modbus communications. ASCII is the default protocol if the HART or Modbus option is not ordered.

Communication Setup Page



Communication Setup page variables are used to configure the protocol and settings of the physical communication interface. The protocol selection is performed at the factory, and may not be changed. Settings for the physical communication interface may be changed for ASCII and Modbus protocols, however, they are restricted for the HART protocol).

Figure 62. Communication setup page

Table 22. Communication setup variables

Variables	Description
Protocol	<p>The Protocol variable identifies the installed protocol driver:</p> <ul style="list-style-type: none"> • None • ASCII (default) • Modbus (option) • HART (option)
Interface	<p>The Interface variable selects the physical communication interface that the transmitter will control during transmit and receive functions:</p> <ul style="list-style-type: none"> • RS232 (available for ASCII or Modbus, not for HART) • RS485 (available for ASCII or Modbus, not for HART) • MODEM (available for HART only) <p>The transmitter must be wired in accordance with this selection (see ELECTRICAL CONNECTIONS starting on page 16).</p>
Baud_Rate	<p>The Baud_Rate variable is used to configure the baud rate of the transmitter's UART, and may be set to: 300,600,1200,2400,4800,9600,14.4k, or 28.8k</p> <p>The value is fixed at 1200 for HART protocol, and defaults to 9600 for Modbus and ASCII.</p>
Parameters	<p>The Parameters variable is used to configure parity, the number of data bits, and number of stop bits of the transmitter's UART:</p> <ul style="list-style-type: none"> • N,8,1 ...no parity, 8 data bits, 1 stop bits • N,8,2 ...no parity, 8 data bits, 2 stop bits • E,8,1 ...even parity, 8 data bits, 1 stop bit • O,8,1 ...odd parity, 8 data bits, 1 stop bit <p>The value is fixed at O,8,1 for HART protocol, and defaults to N,8,1 for Modbus and ASCII.</p>

Protocol specific settings are configured on separate pages that are accessible from links on the Setup page, and are discussed below.

ASCII

ASCII is used for sending the data log to a serial printer, terminal, or terminal program, using RS232 (RS485 might be used under certain conditions). Handshaking is XON/XOFF only, and the Communication Setup page may be used to configure the interface, baud rate, and communication variables. See RS232 Modbus, PC Capture, or Printer for connection details. There are no additional pages for protocol variables.

HART

HART is a master/slave protocol that supports 1 or 2 masters, and up to 15 slave devices. Devices communicate digitally at an effective rate of 1200 baud by modulating the 4-20mA loop. Modulation is performed by a modem that conforms to the BELL 202 standard, which uses FSK (frequency shift keying), where 1200Hz represents a logic 1, and 2200Hz represents logic 0, and does not affect the loop's DC level. Connections are typically point-to-point, which enables bi-directional digital communication and preserves the transmitter's analog output signal. Up to 15 devices may be connected in a multi-drop configuration for digital communication, but requires each device to fix its output at 4mA. See HART Transmitter connection examples in ELECTRICAL CONNECTIONS on page 16, or consult the HART Foundation for additional details on connecting a HART transmitter.

When the HART protocol driver is installed, a link to the HART Setup page appears on the main Setup page.

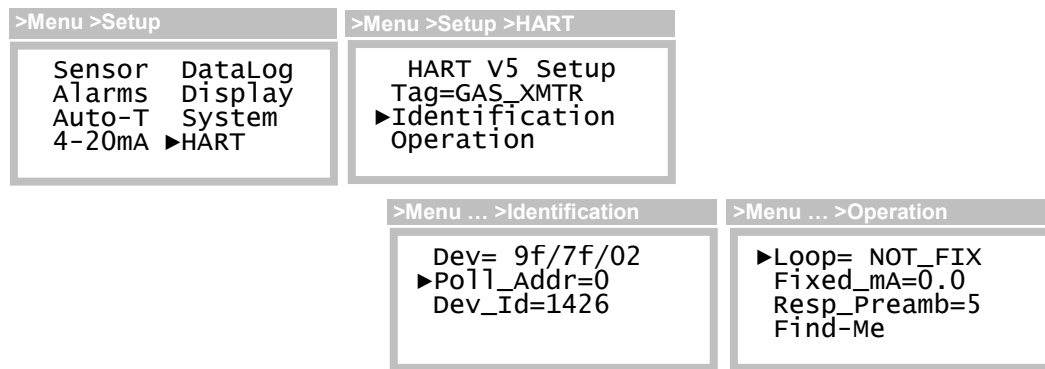

Figure 63. Hart setup pages

Table 23. HART setup variables

Variables	Description
Tag	The Tag variable can be used as a unique identifier for communicating to the transmitter. The variable is read only at the operator interface, but may be modified using HART network management commands.
Dev	The Dev variable displays read-only device information used in long-frame address commands, and by devices capable of utilizing the transmitter's DDL (device description language) file. The format of the information is, MFG_ID/DEV/REV. The MFG_ID is 9f, and identifies Analytical Technology, Inc as the manufacturer. DEV is 7f, and identifies the device as a D12 transmitter. REV is the revision level of the transmitter, currently set at 2 (may increment in the future).

Poll_Addr	The Poll_Addr variable sets the polling address of the transmitter. The default value is 0, which allows the transmitter to communicate digitally, while preserving the function of the 4-20mA output. The value may be set from 1 to 15, which fixes the output at 4mA, and disables analog signaling.
Dev_Id	The Dev_Id variable is used to form a unique identifier in the HART long frame address. This value is set at the factory, and appears on a label attached to the transmitter. Changing this setting is not recommended.
Loop	The Loop variable specifies the operation of the 4-20mA output. When the HART polling address is 0, the value is NOT_FIX and loop functions as normal. When the address is set to 1 or higher, the value is FIXED and the output is fixed at 4mA. The ability to alter this behavior is reserved for future use, and changing this setting is not recommended.
Fixed_mA	The Fixed_mA variable provides direct access the associated HART network management variable. The value is adjustable only when the Loop variable is FIXED, and may be adjusted between 3.5 and 22 mA.
Resp_Preamb	The Resp_Pream variable provides direct access to the associated HART network management variable, which determines the number of preamble characters (FF hex) transmitted at the beginning of each message. The default value is 5, and may be set from 3 to 20. Changing this setting is not recommended.
Find-Me	The Find-Me function places the transmitter into the Find-Me mode, where a master device can issue a command to positively identify the physical location of the transmitter.

Selecting the Find-Me function presents the special page that remains until the master device issues a “Find-Me” command to the transmitter, at which point the display changes to the “Device Found” page.

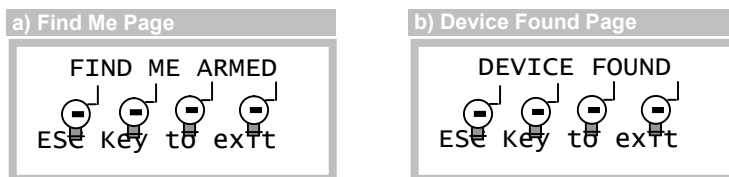

Figure 64. Hart a) Find-me and b) Device found pages

Modbus

Modbus is a master/slave protocol that supports a single master, and up to 247 slave devices on a common bus. The RS485 interface physically limits this number to 32 (1 master, 31 slaves), and RS232 restricts communication to a master and a single slave. The Communication Setup page may be used to configure the interface, baud rate, and communication variables. See RS485 Modbus Multidrop and RS232 Modbus, PC Capture, or Printer for connection details.

When the Modbus protocol driver is installed, a link to the Modbus Setup page appears on the main Setup page.

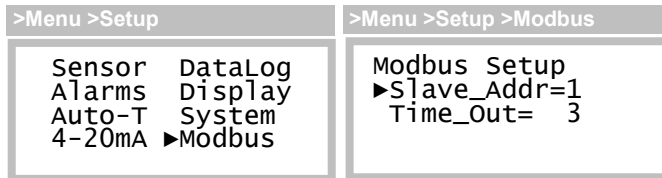

Figure 65. Modbus setup page

Table 24. Modbus setup variables

Variables	Description
Slave_Addr	The Slave_Addr variable is the transmitter's slave address, which may set from 1 (default) to 247.
Time_Out	The Time_Out variable belongs to the data-link layer of the protocol and defines the number of 1.5 character timeouts used to frame messages. This variable is reserved for future use and changing it is not recommended.

Transmitter Version

The Transmitter Version page displays transmitter information:

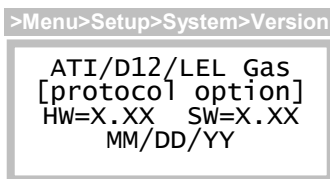

- Line 1: model and version name
- Line 2: protocol option (ASCII,HART,or Modbus)
- Line 3: hardware and software version numbers
- Line 4: software build date

Figure 66. Transmitter version page

Restart

The Restart function will cause the transmitter to start up, just as it does during a power-on-reset. This function replaces the Reset page beginning with version 2.23 of the D12 Combustible Gas Transmitter with Catalytic Bead sensor.

Resets

Note: the Reset page has been removed on software versions 2.23, and higher.

The Reset page provides functions for resetting configuration memories, and restarting the transmitter, which may prove useful for correcting specific faults. These functions should **not be used** unless they are specified in troubleshooting procedures, or directed by authorized factory personnel.

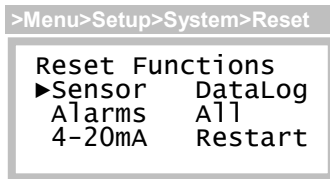
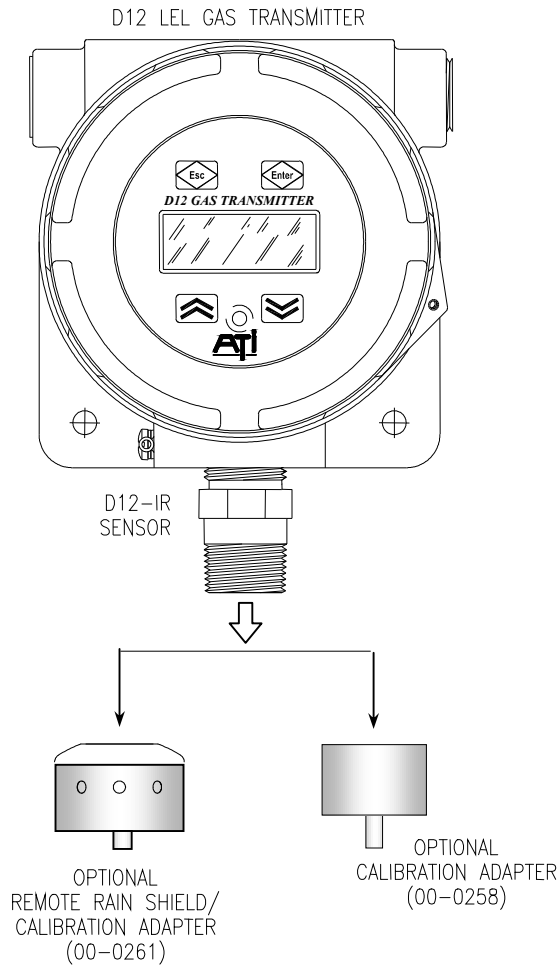

Table 25. Reset functions (do not use except for troubleshooting).

Function	Description
Sensor	Resets zero and span calibration, restarts transmitter. <u>Sensor must be completely recalibrated.</u> On LEL transmitters, calibration and Auto-test history are cleared.
Alarms	Resets alarm set/reset points, options, delays, and inhibit_mA, restarts transmitter.
4-20mA	Resets 4-20mA calibration, loop must be recalibrated, restarts transmitter.
DataLog	Clears the data log history, restarts transmitter.
All	Resets entire transmitter to factory defaults, excluding sensor, restarts transmitter. <u>Requires full transmitter setup.</u>
Restart	Restarts the transmitter.

SPARE PARTS



Part No.	Description
00-1375 (HC)	Standard LEL (low range) hydrocarbon sensor for Methane, Propane, Butane, Pentane, etc.
00-1376 (HHC)	High range hydrocarbon sensor for high concentrations (normally above the UEL) of Propane, Butane, LPG.
00-1377 (CO2)	Standard range Carbon dioxide sensor
00-1378 (HCO2)	High range Carbon dioxide sensor
00-1431 (N2O)	Standard range Nitrous oxide sensor
03-0303	D12-IR (3) Board Stack Assembly, Without Relays
03-0304	D12-IR (3) Board Stack Assembly, With Relays
03-0316	Remote IR Sensor Cable Assembly
00-0258	Calibration adapter
00-0261	Remote Calibration Adapter / Rain Shield
29-0007	Battery
55-0004	Magnetic Screwdriver

Appendix A.

Printing Data Log Reports

The following pages describe how to send a data-log report to a printer or computer, over a serial RS232 connection, and to import that data into Microsoft Excel for plotting.



Serial Connection

The data log report may be sent to a printer or a computer over an RS232 connection, or in some cases, an RS485 connection.

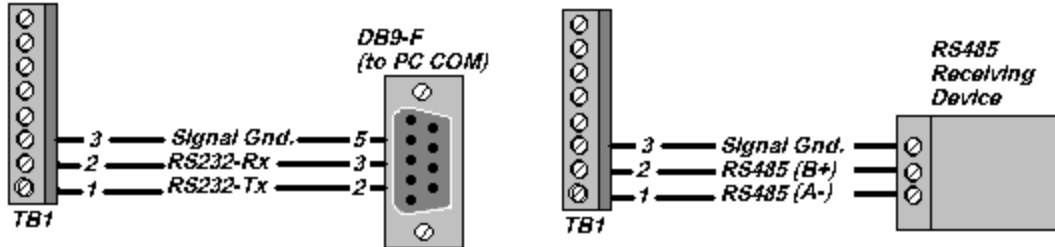

Communication Setup Page

Menu>Setup>System>Commun

```

▶Protocol=ASCII
Interface=RS232
Baud_Rate=9600
Parameters=N,8,1
    
```

The communication interface, baud rate, parity, number of data bits, and number of stop bits are configured on the Communication Setup page.

Flow Control

The transmitter uses XON/XOFF flow control while sending a report. That is, once the data stream has begun, it will continue until the XOFF character (19) is received. After sitting idle, the report stream will begin again upon reception of the XON character (17).

An RS232 connection can support full duplex communication and is perfectly suited for XON/XOFF flow control. However, an RS485 connection is only half duplex. It cannot receive while it is transmitting and might miss the XOFF character, resulting in a buffer overflow at the receiving device.

A receiving device will send the XOFF character when its buffer is nearly full. Some older dot-matrix printers will send an XOFF because they have a small receive buffers and cannot process characters while the head is returning to start a new line. On the other hand, most computers have comparatively large buffers and can easily accept the report stream without sending an XOFF. Therefore, an RS485 connection may work for sending reports to a computer.

The D12 features an additional method to help avoid losing data due to buffer overflow problems on receiving devices that lack XON/XOFF capability (or have the capability but are using an RS485 connection). A programmable time delay of up to 10s may be inserted at the end of each report line. This permits the receiver time to process more characters in its buffer and avoid an overflow. However, this may be a method of trial and error until the proper delay setting is determined so that no characters are missing from the report.

Report Format

The format of the report is suitable for import into most spreadsheet programs and consists of a date column, a time column, and 1-30 columns for sample values. Each line of the report shows the date and time of the first sample. Samples appearing in subsequent columns (left to right) were recorded at equal sampling intervals.

In the top line of the example below, the first sample (S0) occurred at 22:40. The next sample to the right (S1) occurred at 22:41, followed by the next (S2) at 22:42, and so on. This pattern is repeated throughout the report.

Date	Time	S0	S1	S2	S3
07/09/06	22:40	0.01	0.00	0.02	0.01
07/09/06	22:44	-0.0	0.00	0.00	-0.0
07/09/06	22:48	0.01	TEST	TEST	TEST
07/09/06	22:52	TEST	TEST	TEST	TEST
07/09/06	22:56	TEST	TEST	TEST	TEST
07/09/06	23:00	0.07	0.06	0.07	0.06
07/09/06	23:04	0.06	0.05	0.06	0.06
07/09/06	23:08	0.05	0.05	0.04	0.05
07/09/06	23:12	0.06	0.05	0.05	0.04
07/09/06	23:16	0.01	0.01	0.01	0.00
07/09/06	23:20	0.00	0.00	0.00	-0.1
07/09/06	23:24	-0.0	0.00	0.00	0.00
07/09/06	23:28	----	----	----	----
07/09/06	23:32	----	----	----	----
07/09/06	23:36	----	----	----	----
07/09/06	23:40	FFFF	FFFF	0.02	0.02

The transmitter permits selection of either a CR (carriage return) or CR/LF (carriage return/line feed) as the EOL (end-of-line) characters. If the lines of the report appear to be printing over each other, choose the CR/LF option. If the lines appear to be double spaced, choose the CR option.

The number of sample columns appearing across the page is programmable from 1 to 30. This is designed so that a report may be directed to either a small carriage printer, or to a wider format device. A wider report will take less time to print because the date and time fields will be printed less frequently.

Samples reported are assumed to be in units of PPM, PPB, %, or %LEL, as determined by the gas concentration units appearing on the main display of the transmitter. Sample values outside of printing limits are forced to the following values.

Samples ...	Are forced to...
Less than -999	-999
Greater than 9999	9999

Symbols may appear in place of sample values, and are defined as follows.

Symbol	Description
----	No sample recorded. The transmitter was not on to record the sample, or has not yet recorded the sample.
FFFF	The transmitter was in fault during the sample.
TEST	The transmitter was in auto-test during the sample. This symbol appears only if the Log_Data variable in the Menu/Setup/Auto-T/Setup menu is set to "NO".
*****	Data in the log is corrupted or unreliable.

Report Control

The start date and length of the report may be controlled from the operator interface. The length of the report is limited to the number of days actually stored in the log. The report always begins at 00:00 on the start date, and continues forward for the number of days specified. If no data has yet been logged, the report will show four dashes (----) in place of samples.

Example: Charting a Data Log Report

Start HyperTerminal by clicking **Start**, pointing to **Programs**, pointing to **Accessories**, pointing to **Communications**, clicking **HyperTerminal**, and then double-clicking **Hyperterm.exe**.

When the **Connection Description** dialog box appears, type in **Connect To D12**. If you wish, choose an icon by sliding the horizontal scroll bar over and clicking one of the selections. Click **OK** when ready.

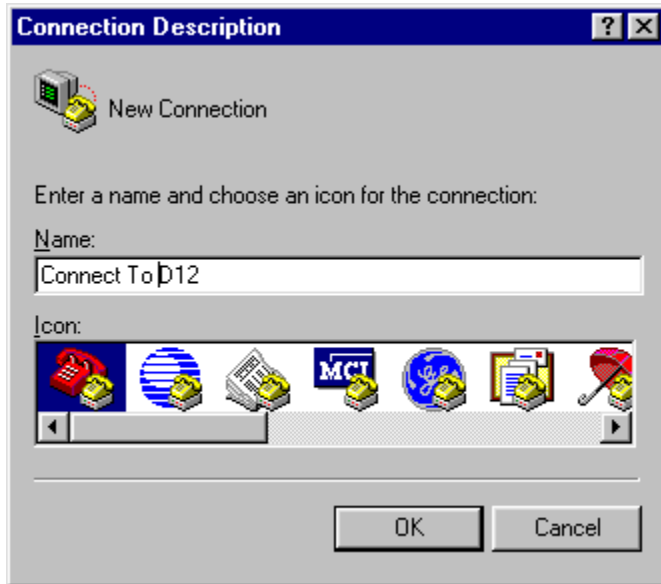

When the **Connect To** dialog appears, set **Connect using:** to **Direct to Com1** (or Direct to Com2 if you are using COM2) and click **OK**.



When the **COM1 Properties** dialog box appears, configure the Port Settings as shown below and click **OK**.

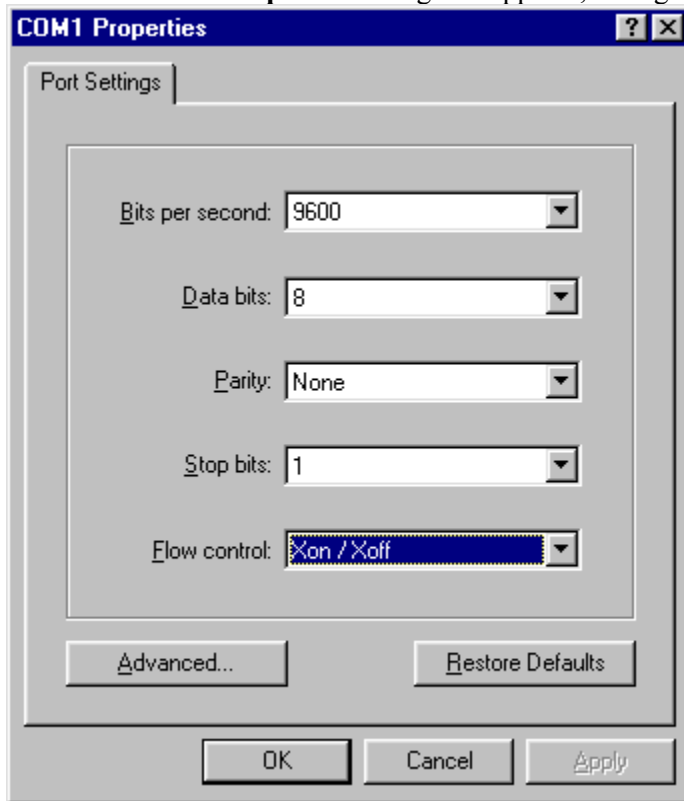

Click **View**, then click **Font** and configure the font settings as shown. This will insure that the data is presented in the terminal window without wrapping from line to line. You may need to experiment with these settings to obtain an acceptable presentation in the terminal window.

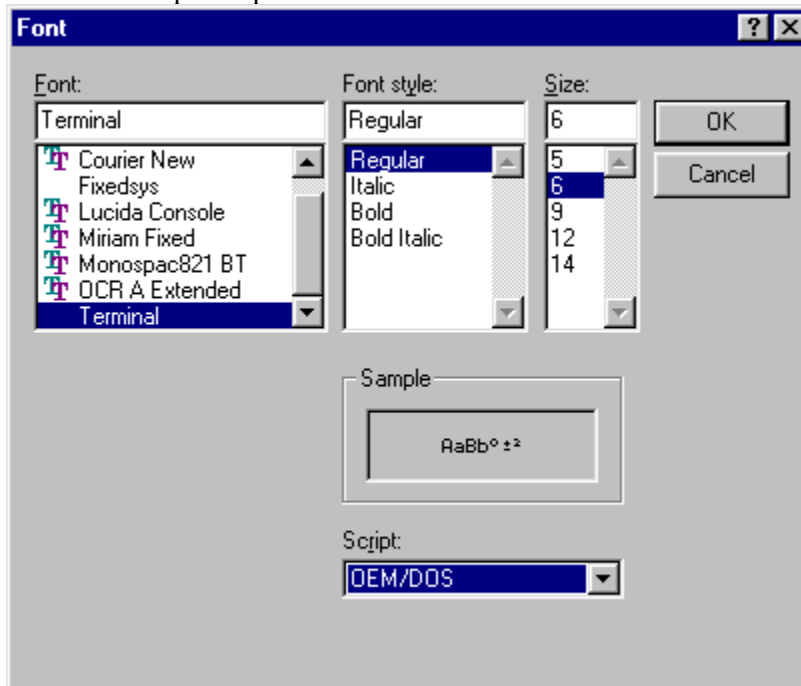

Click **OK** when finished.

Click **File**, then click **Save As**, and click the **Save** button to store the settings as a HyperTerminal session file named Connect To D12.ht (the filename should automatically appear). You may later place this file on your desktop and simply click it to get this point automatically.

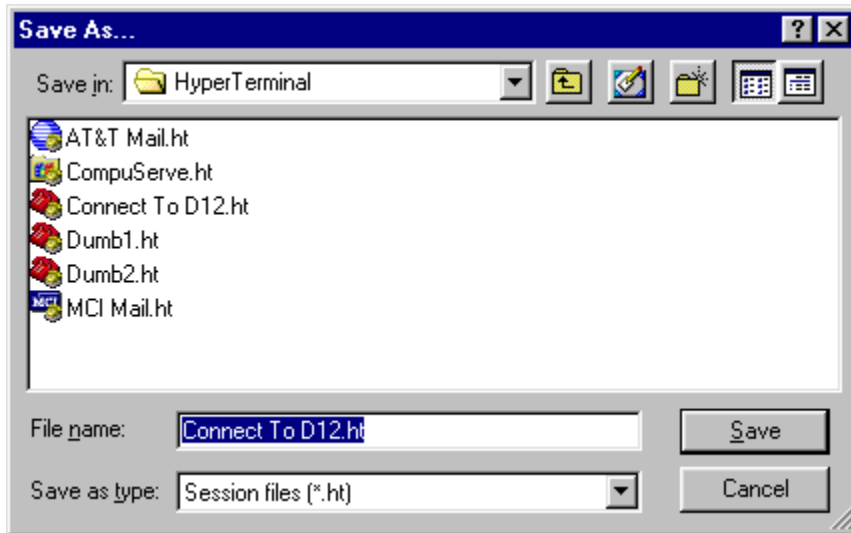

In order to chart the report data, it must be “captured” in a file and given a name. Click **Transfer** on the menu bar, click **Capture Text**, and then click the **Browse** button. Navigate to a folder and type the name of a file to store the report in (or choose an existing file to append the new report).

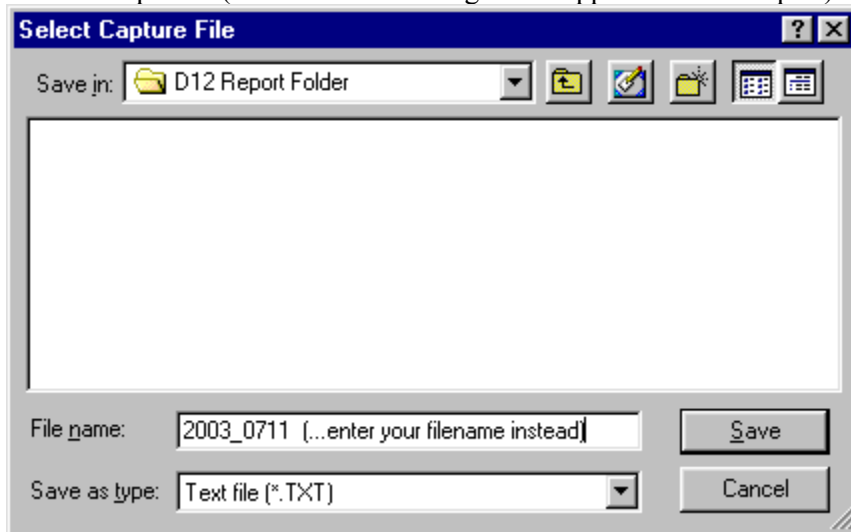

Click the **Save** button to return to the **Capture Text** dialog box. When the **Capture Text** dialog box reappears, click the **Start** button.

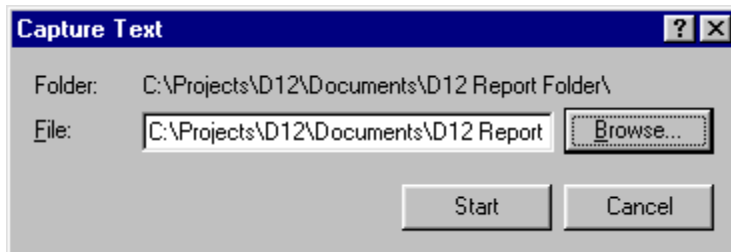

HyperTerminal is now ready to accept a report from the D12 transmitter and save it in a file. Note that data may appear in the terminal window (shown below) if the Connect To D12 session has been run previously, but this data will not appear in the file just opened.

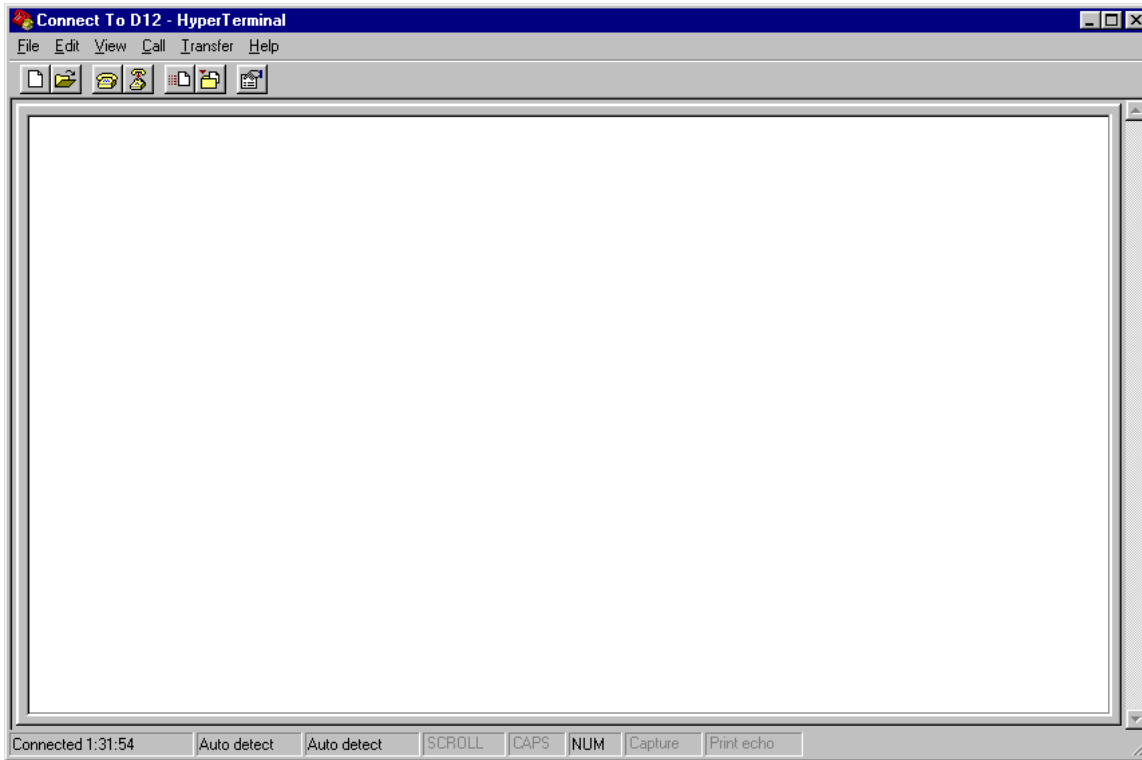

Starting the Report

Prior to sending a report to the computer, the system clock should be set and the data logger turned on to record at least one sample. In addition, the Log_Data variable (in the Menu/Setup/Auto-T/Setup menu) should be set to NO if you prefer to see the symbol TEST and not gas concentration values during auto-test.

Configure the communication variables as shown below. Note that 9600 is the highest baud rate common to the D12 transmitter and the Hyperterminal program.

Menu>Setup>System>Commun

```
►Protocol=ASCII  
Interface=RS232  
Baud_Rate=9600  
Paramtrs=N, 8, 1
```

Navigate to the DataLog page and select Print. You will not be allowed access if there are no samples in the log.

```
>Menu >Setup
Sensor      ▶DataLog
Alarms     Display
Auto-T     System
4-20mA
```

```
>Menu >Setup >DataLog
Setup
Review_Tabular
Review_Graphic
▶Print
```

Select the first (starting) date. This will automatically re-compute the maximum number of days shown of the report (variable values will most likely differ from yours).

```
>Menu >Setup >DataLog >Print
▶First=07/13/06
Days= 2 of 2
Page_Setup
Start Printing
```

Edit the Days variable if you prefer to reduce the length of the report, otherwise the entire report will be printed.

```
>Menu >Setup >DataLog >Print
First=07/13/06
▶Days= 1 of 2
Page_Setup
Start Printing
```

Select Page_Setup and configure the Width, Eol, and EoIDly variables as shown. The Width variable controls the number of sample columns printed and is settable from 1 to 30. Since the Hyperterminal display is 80 characters wide, set this to 10 columns so that data does not wrap around to the next line. Set Eol for CR/LF, and EoIDly to 0.

```
>Menu >Setup >DataLog >Print
▶Width= 10 Samp1s
Eol=CR/LF
EoIDly=0      ms
```

Escape from Page_Setup and select Start_Printing. "Printing" will begin flashing, and you may stop at any time by touching the Esc key.

```
>Menu >Setup >DataLog >Print
First=07/13/06
Days= 1 of 2
Page_Setup
▶Start Printing
```

```
>Menu >Setup >DataLog >Print
First=07/13/06
Days= 1 of 2
Page_Setup
Printing
```

The HyperTerminal terminal window should now begin to fill with lines from the report.

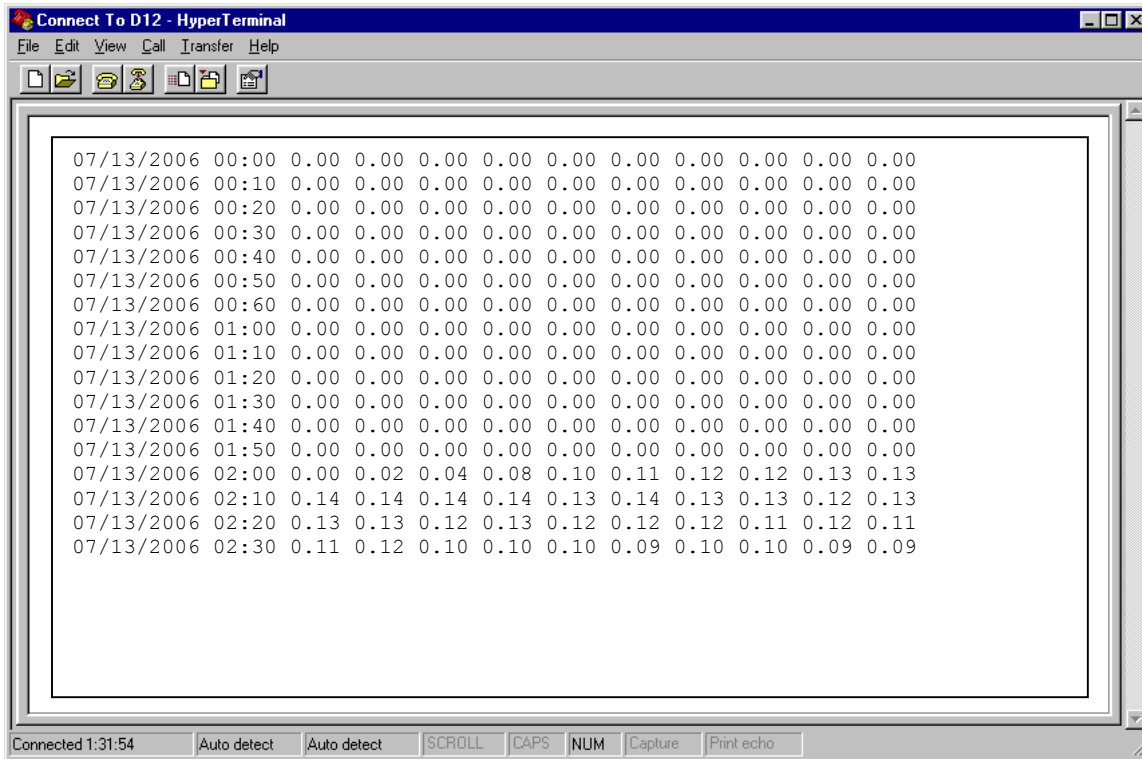

When the transmitter has stopped printing (displays Start_Printing), click **Transfer**, move down to **Capture Text** and click **Stop**. This will close the report file so that it may be opened by another program.

Charting with Microsoft Excel

Microsoft Excel can be used to import data log reports and create useful and informative charts.

Start Excel by clicking **Start**, pointing to **Programs**, and clicking **Microsoft Excel**.

When Excel opens, click **File** and then click **Open**. Navigate to the data log report file you wish to chart and click **Open**. Excel will recognize the report as a text file and offer some configuration options.

When the **Text Import Wizard – Step 1 of 3** appears, configure the settings as shown below and click **Next**. (Note that the values in your report file will be different than those shown below.)

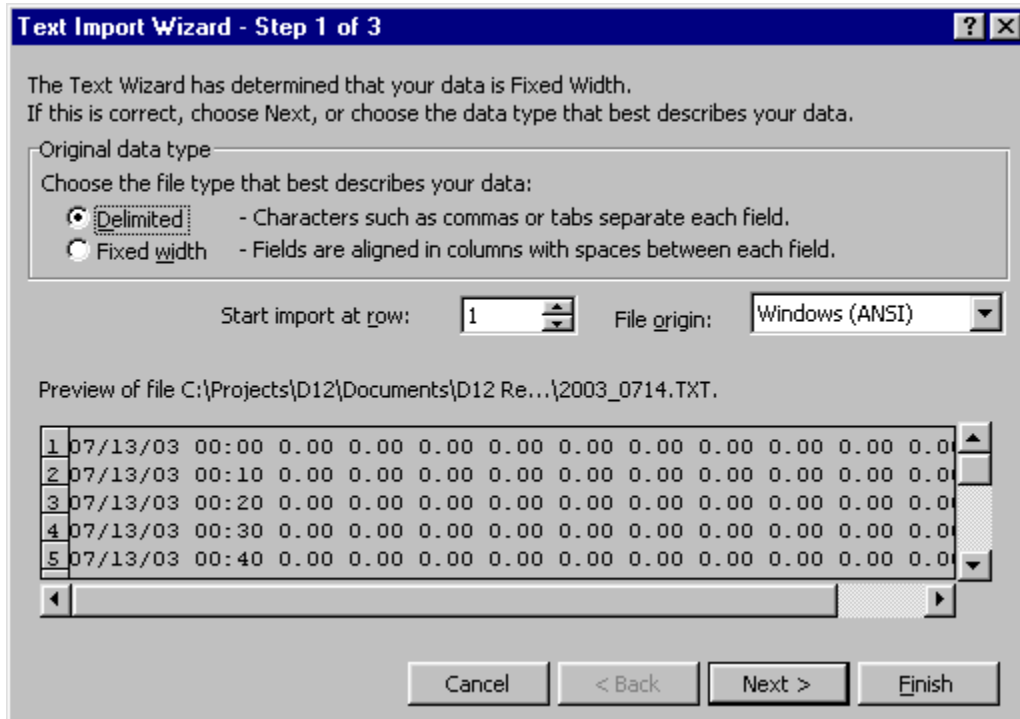

When the **Text Import Wizard – Step 2 of 3** appears, configure the settings as shown below and click **Next**.

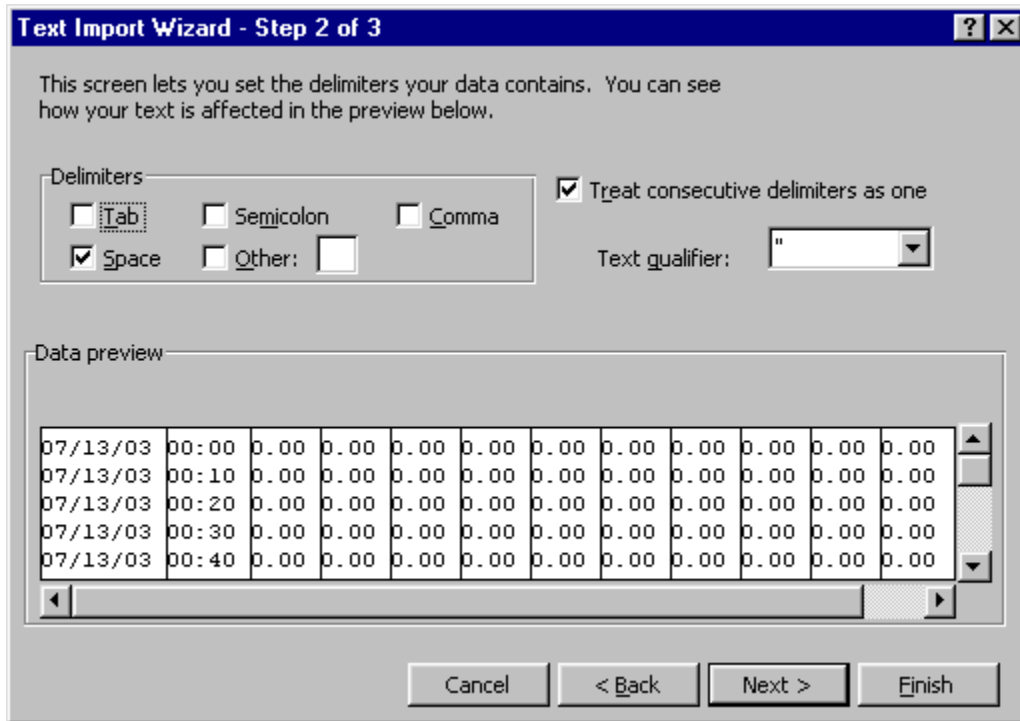

When the **Text Import Wizard – Step 3 of 3** appears, click **Finish**.

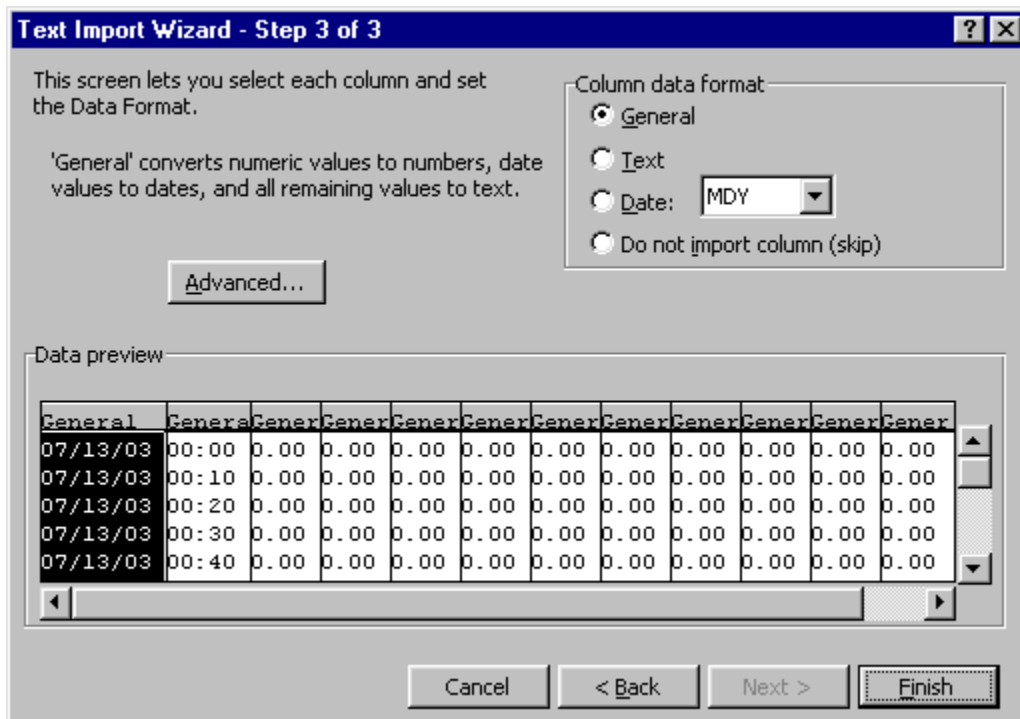

The report should appear as a spreadsheet resembling the format shown below. Of course the dates, times, and values will be different.

	A	B	C	D	E	F	G	H	I	J	K	L	M	N	O	P	Q
1	7H1303	0.00	C	0	0	0	0	0	0	0	0	0	0	0	0	0	0
2	6EP11	0.00	I	0	0	0	0	0	0	0	0	0	0	0	0	0	0
3	7H1303	0.00	C	0	0	0	0	0	0	0	0	0	0	0	0	0	0
4	7H1303	0.00	L	U	U	U	U	U	U	U	U	U	U	U	U	U	U
5	6EP11	0.00	I	0	0	0	0	0	0	0	0	0	0	0	0	0	0
6	7H1303	0.00	C	0	0	0	0	0	0	0	0	0	0	0	0	0	0
7	6EP11	0.00	I	0	0	0	0	0	0	0	0	0	0	0	0	0	0
8	7H1303	0.00	C	0	0	0	0	0	0	0	0	0	0	0	0	0	0
9	7H1303	0.00	C	0	0	0	0	0	0	0	0	0	0	0	0	0	0
10	6EP11	0.00	I	0	0	0	0	0	0	0	0	0	0	0	0	0	0
11	7H1303	0.00	C	0	0	0	0	0	0	0	0	0	0	0	0	0	0
12	7H1303	0.00	L	U	U	U	U	U	U	U	U	U	U	U	U	U	U
13	7H1303	0.00	F	0.02	0.04	0.06	0.08	0.10	0.12	0.14	0.16	0.18	0.20	0.22	0.24	0.26	0.28
14	7H1303	0.00	C	0.4	0.4	0.4	0.4	0.4	0.4	0.4	0.4	0.4	0.4	0.4	0.4	0.4	0.4
15	6EP11	0.00	I	0.02	0.02	0.02	0.02	0.02	0.02	0.02	0.02	0.02	0.02	0.02	0.02	0.02	0.02
16	7H1303	0.00	C	0.2	0.1	0.1	0.1	0.1	0.02	0.1	0.09	0.09	0.09	0.09	0.09	0.09	0.09
17	7H1303	0.00	C	0.09	0.09	0.1	0.09	0.09	0.09	0.08	0.08	0.08	0.08	0.08	0.08	0.08	0.08
18	6EP11	0.00	I	0.00	0.00	0.00	0.00	0.00	0.00	0.00	0.00	0.00	0.00	0.00	0.00	0.00	0.00
19	7H1303	0.00	C	0.06	0.06	0.06	0.06	0.06	0.06	0.06	0.06	0.06	0.06	0.06	0.06	0.06	0.06
20	6EP11	0.00	I	0.06	0.06	0.06	0.06	0.06	0.06	0.06	0.06	0.06	0.06	0.06	0.06	0.06	0.06
21	7H1303	0.00	C	0.04	0.04	0.04	0.04	0.04	0.04	0.04	0.04	0.04	0.04	0.04	0.04	0.04	0.04
22	7H1303	0.00	C	0.08	0.08	0.08	0.08	0.08	0.08	0.08	0.08	0.08	0.08	0.08	0.08	0.08	0.08
23	6EP11	0.00	I	0.00	0.00	0.00	0.00	0.00	0.00	0.00	0.00	0.00	0.00	0.00	0.00	0.00	0.00
24	7H1303	0.00	C	0	0	0	0	0	0	0	0	0	0	0	0	0	0
25	7H1303	0.00	L	U	U	U	U	U	U	U	U	U	U	U	U	U	U
26	6EP11	0.00	I	0	0	0	0	0	0	0	0	0	0	0	0	0	0
27	7H1303	0.00	C	0	0	0	0	0	0	0	0	0	0	0	0	0	0
28	6EP11	0.00	I	0	0	0	0	0	0	0	0	0	0	0	0	0	0
29	7H1303	0.00	C	0	0	0	0	0	0	0	0	0	0	0	0	0	0
30	7H1303	0.00	C	0	0	0	0	0	0	0	0	0	0	0	0	0	0
31	6EP11	0.00	I	0	0	0	0	0	0	0	0	0	0	0	0	0	0
32	7H1303	0.00	C	0	0	0	0	0	0	0	0	0	0	0	0	0	0

To chart the report, select one full day of data by dragging the mouse cursor over the region to be charted. Notice that this region begins in the time of day column and extends across each of the sample columns.

	A	B	C	D	E	F	G	H	I	J	K	L	M	N	O
1	7/13/03	0.00	0	0	0	0	0	0	0	0	0	0	0		
2	7/13/03	0.00	0	0	0	0	0	0	0	0	0	0	0		
3	7/13/03	0.00	0	0	0	0	0	0	0	0	0	0	0		
4	7/13/03	0.00	0	0	0	0	0	0	0	0	0	0	0		
5	7/13/03	0.00	0	0	0	0	0	0	0	0	0	0	0		
6	7/13/03	0.00	0	0	0	0	0	0	0	0	0	0	0		
7	7/13/03	0.00	0	0	0	0	0	0	0	0	0	0	0		
8	7/13/03	0.00	0	0	0	0	0	0	0	0	0	0	0		
9	7/13/03	0.00	0	0	0	0	0	0	0	0	0	0	0		
10	7/13/03	0.00	0	0	0	0	0	0	0	0	0	0	0		
11	7/13/03	0.00	0	0	0	0	0	0	0	0	0	0	0		
12	7/13/03	0.00	0	0	0	0	0	0	0	0	0	0	0		
13	7/13/03	0.00	0	0	0	0	0	0	0	0	0	0	0		
14	7/13/03	0.10	0.10	0.10	0.10	0.10	0.10	0.10	0.10	0.10	0.10	0.10	0.10		
15	7/13/03	0.12	0.12	0.12	0.12	0.12	0.12	0.12	0.12	0.12	0.12	0.12	0.12		
16	7/13/03	0.14	0.14	0.14	0.14	0.14	0.14	0.14	0.14	0.14	0.14	0.14	0.14		
17	7/13/03	0.16	0.16	0.16	0.16	0.16	0.16	0.16	0.16	0.16	0.16	0.16	0.16		
18	7/13/03	0.18	0.18	0.18	0.18	0.18	0.18	0.18	0.18	0.18	0.18	0.18	0.18		
19	7/13/03	0.20	0.20	0.20	0.20	0.20	0.20	0.20	0.20	0.20	0.20	0.20	0.20		
20	7/13/03	0.21	0.21	0.21	0.21	0.21	0.21	0.21	0.21	0.21	0.21	0.21	0.21		
21	7/13/03	0.20	0.20	0.20	0.20	0.20	0.20	0.20	0.20	0.20	0.20	0.20	0.20		
22	7/13/03	0.18	0.18	0.18	0.18	0.18	0.18	0.18	0.18	0.18	0.18	0.18	0.18		
23	7/13/03	0.16	0.16	0.16	0.16	0.16	0.16	0.16	0.16	0.16	0.16	0.16	0.16		
24	7/13/03	0.14	0.14	0.14	0.14	0.14	0.14	0.14	0.14	0.14	0.14	0.14	0.14		
25	7/13/03	0.12	0.12	0.12	0.12	0.12	0.12	0.12	0.12	0.12	0.12	0.12	0.12		
26	7/13/03	0.10	0.10	0.10	0.10	0.10	0.10	0.10	0.10	0.10	0.10	0.10	0.10		
27	7/13/03	0.08	0.08	0.08	0.08	0.08	0.08	0.08	0.08	0.08	0.08	0.08	0.08		
28	7/13/03	0.06	0.06	0.06	0.06	0.06	0.06	0.06	0.06	0.06	0.06	0.06	0.06		
29	7/13/03	0.04	0.04	0.04	0.04	0.04	0.04	0.04	0.04	0.04	0.04	0.04	0.04		
30	7/13/03	0.02	0.02	0.02	0.02	0.02	0.02	0.02	0.02	0.02	0.02	0.02	0.02		
31	7/13/03	0.00	0.00	0.00	0.00	0.00	0.00	0.00	0.00	0.00	0.00	0.00	0.00		
32	7/13/03	0.00	0.00	0.00	0.00	0.00	0.00	0.00	0.00	0.00	0.00	0.00	0.00		

After selecting the region, click Insert and then Chart (or click the Chart icon directly from the toolbar).

When the **Chart Type** dialog appears, click on **Column**, and click **Next**.

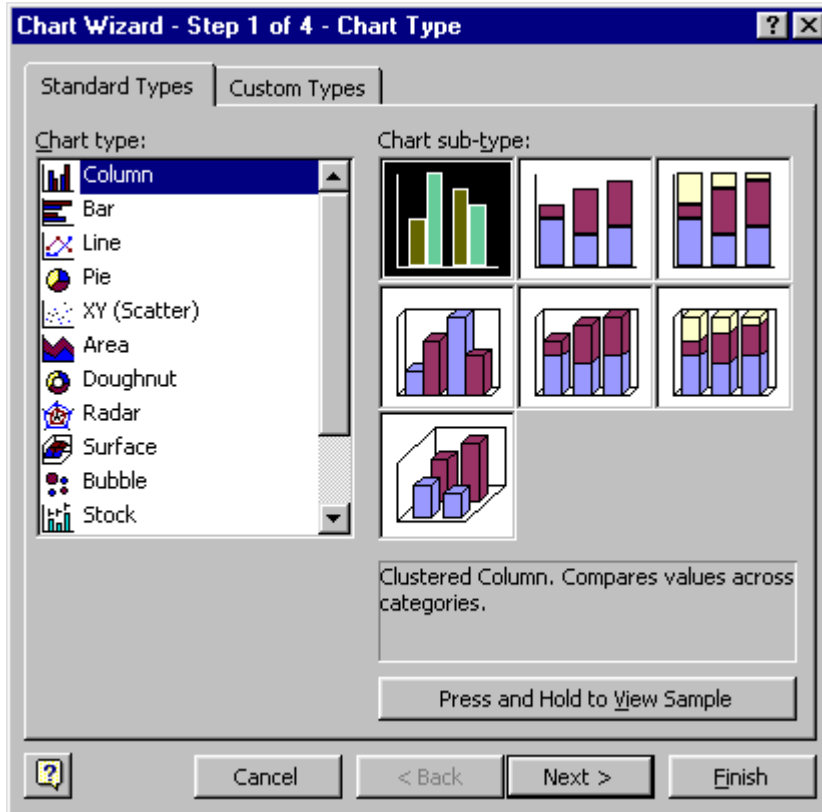

When the **Chart Source Data** dialog appears, click **Next**.

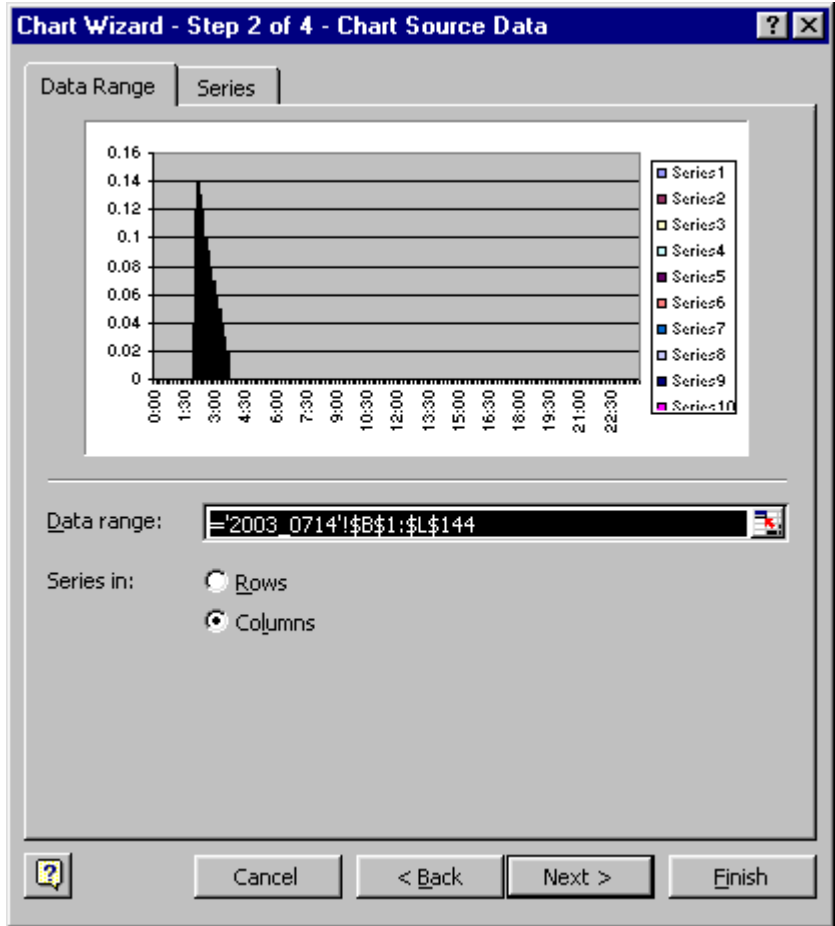

When the **Chart Options** dialog appears, click off the **Show legend** option, and click **Next**.

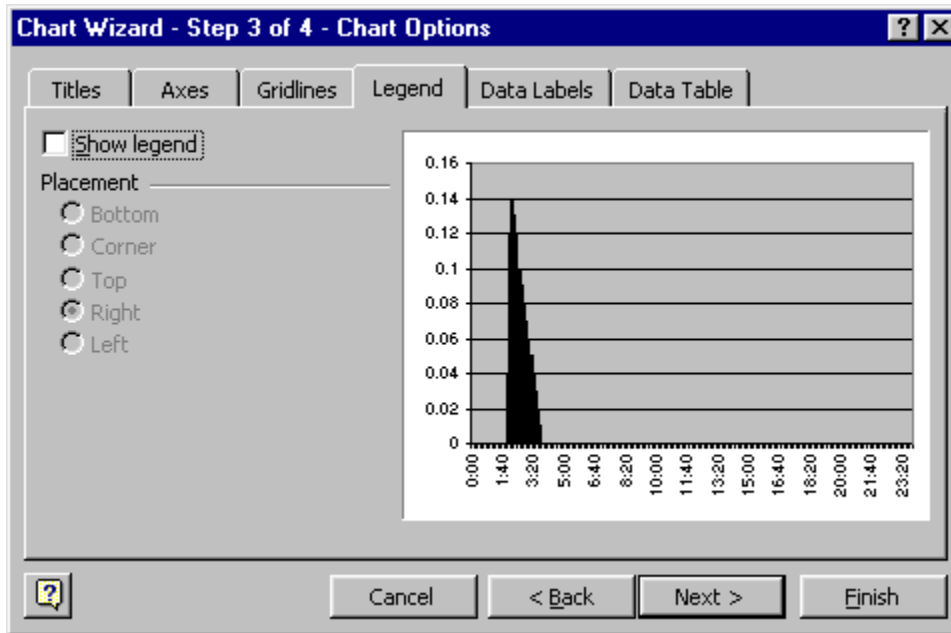

When the **Chart Location** dialog appears, click the **As new sheet** radio button and enter the name of a new sheet to store the chart in. Alternately, you may click the **As object in** radio button to place the chart onto the sheet you have just created.

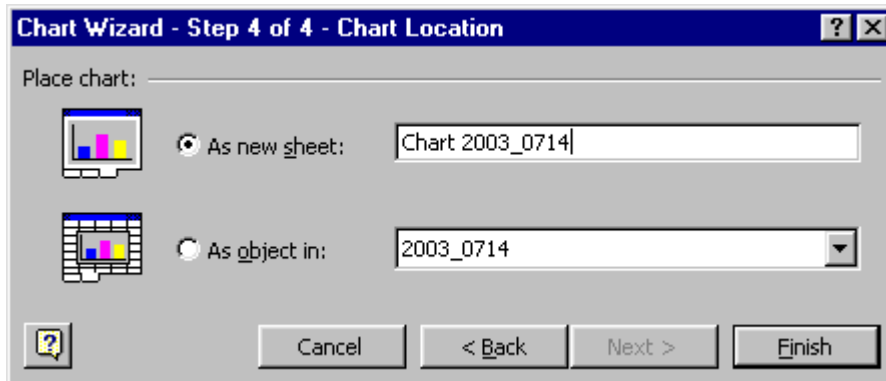

If you have previously clicked the **As new sheet** radio button, the chart will appear on the new sheet named above. You may now move between the new sheet and the old sheet by clicking the sheet tabs that appear just below the chart display.

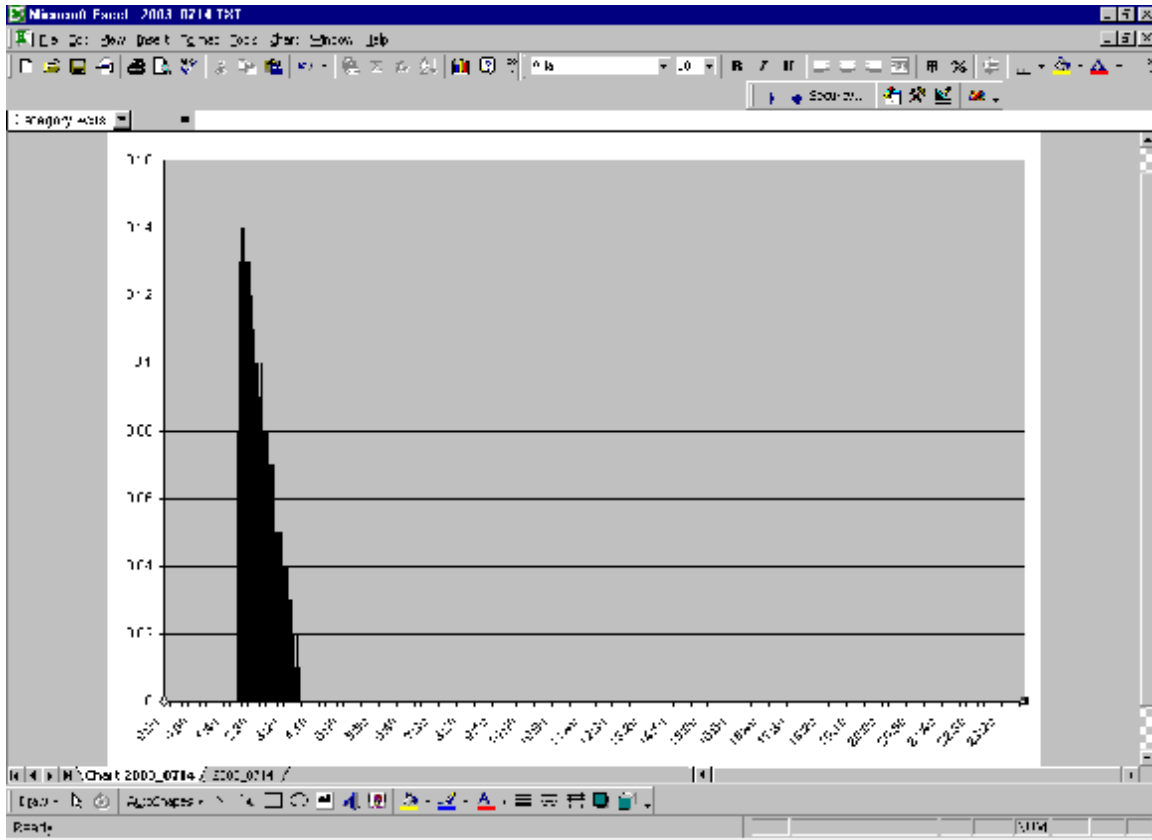

If you have previously clicked the **As object in:** radio button, the chart will appear on the existing sheet.

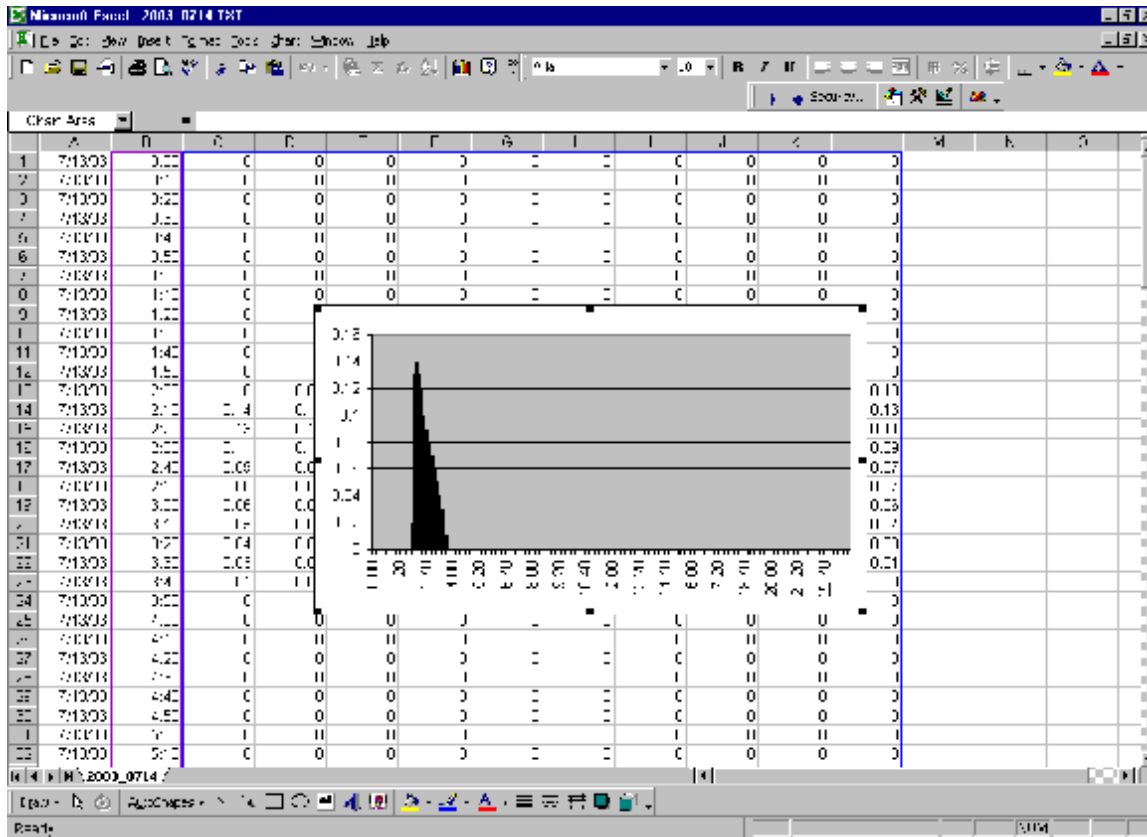

Finally, click **File**, then **Save** to store the chart.

Once the chart has been created, you may wish to rescale it, title it, and print it. These features are detailed in Microsoft Excel Help and are beyond the scope of this document.