

NUMATICS®

WBG Series

Wide Body Grippers

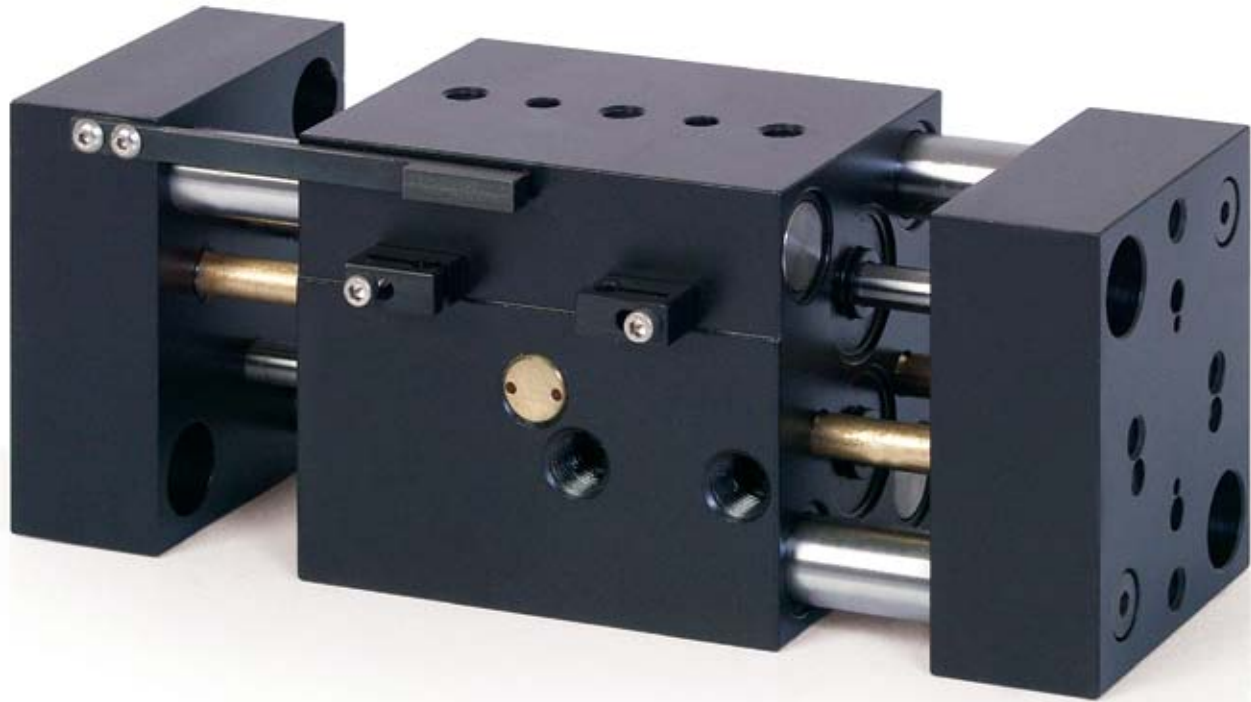

www.numatics.com

WBG Series Parallel Grippers

Features and Benefits	3
How To Order	3
WBG 60 Dimensions & Technical Specifications	4
WBG 90 Dimensions & Technical Specifications	5
WBG 90 Dimensions & Technical Specifications	6
WBG 90 Dimensions & Technical Specifications	7
WBG 200 Dimensions & Technical Specifications	8
WBG 200 Dimensions & Technical Specifications	9
WBG 200 Dimensions & Technical Specifications	10
WBG 300 Dimensions & Technical Specifications	11
WBG 300 Dimensions & Technical Specifications	12
WBG 300 Dimensions & Technical Specifications	13
Switches	14
Quick Disconnect Cables	15

Gripper Summary of Operation

WBG-Series utilizes four independent pistons to power the jaws open and closed. Jaws utilize a rack and pinion for synchronization which are independent from force rods and support rods. Non-Synchronous operation is available.

A. Body

High Strength, Anodized aluminum.
Ultra high gripping force to weight ratio.

B. Support rods

Hardened steel support shafts are guided through the full width of the body. Wiper seals assist in keeping rods free of debris.

C. Seals

- Piston seals are quad ring type for long service life.
- Pre-lubricated with our specially formulated oil based compound for extensive maintenance free performance.
 - Proximity switches are available to monitor open and closed position of the jaws.

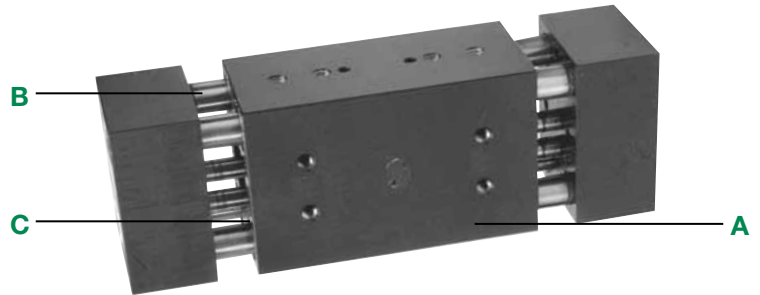

How to Order

WBG S 60 S 1 W C X

Gripper Stroke

- S = Short
- L = Long
- X* = Extra Long
- *Only available in WBG 90 Series.

Gripper Model Number

- 60
- 90
- 200
- 300

Gripper Motion

- S = Synchronous
- C = Compliant

Seal Type

- 1 = Buna-N
- 2 = FKM

Options

- X = Standard

Sensing Position

- A = Single Position Open
- B = Single Position Closed
- C = Two Position Sensing
- D = No Sensing

Sensing Type

- Standard Cord Set
 - 4 = Prox Switch - PNP (sourcing)
 - 5 = Prox Switch - NPN (sinking)
 - 6 = No Sensing
 - Quick Disconnect Cord Set
 - W = Prox Switch - PNP (sourcing) Straight
 - V = Prox Switch - NPN (sinking) Straight
 - U = Prox Switch - PNP (sourcing) 90 Deg.
 - T = Prox Switch - NPN (sinking) 90 Deg.
- Prox switches are 4 mm diameter.

When ordering additional switches:

Switch Description	Standard Part No.	Quick Disconnect Part No.
Prox Switch - PNP (Sourcing)	PROX-4FL2-P	PROX-4QDS-P
Prox Switch - NPN (Sinking)	PROX-4FL2-N	Not Available
Quick disconnect cable straight	-	PXCST
Quick disconnect cable 90 deg.	-	PXC90

Dimensions: Inches

WBG 60 Series

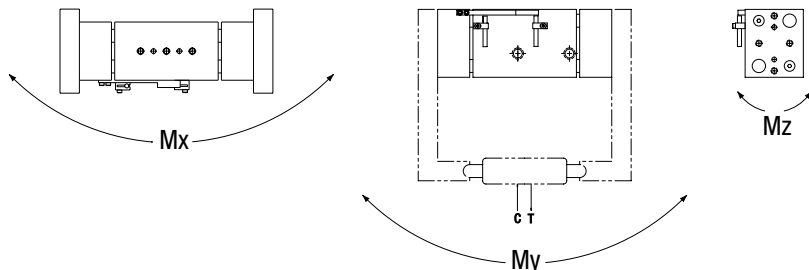
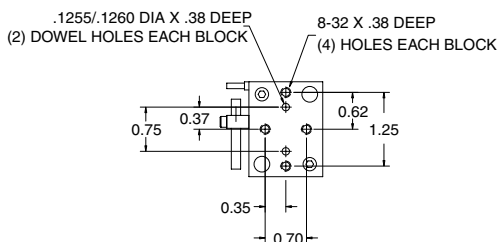
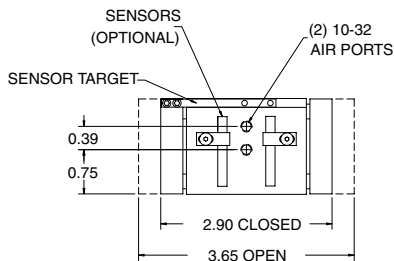
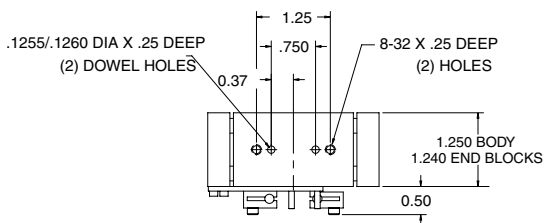
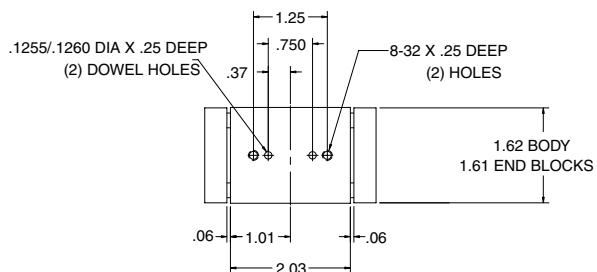

Specifications

Load Capacity	WBG60
Grip Force @ 100 psi	60 lbs
Stroke	0.75
Repeatability	+/- .001
Operating Temp.	
Buna-N	-30° to 180°F
FKM	-20° to 350°F
Max. Actuation Speed	0.3 sec
Displacement	0.29 cu. in.
Maximum Pressure	120 psi
Unit Weight	11 oz

Static Condition

Load Capacity	WBG60
C-compression	50 lbs.
T-tension	50 lbs.
Mx	100 in.-lbs.
My	150 in.-lbs.
Mz	100 in.-lbs.

Dynamic Condition

Load Capacity	WBG60
C-compression	10 lbs.
T-tension	10 lbs.
Mx	20 in.-lbs.
My	30 in.-lbs.
Mz	20 in.-lbs.

**WBG-60
Gripping Force Chart
Per Finger @ 80 psi**

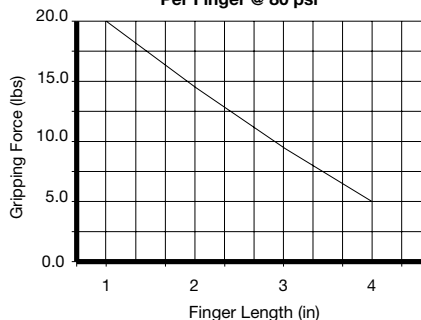

Dimensions: Inches (mm)

WBGs 90 Series

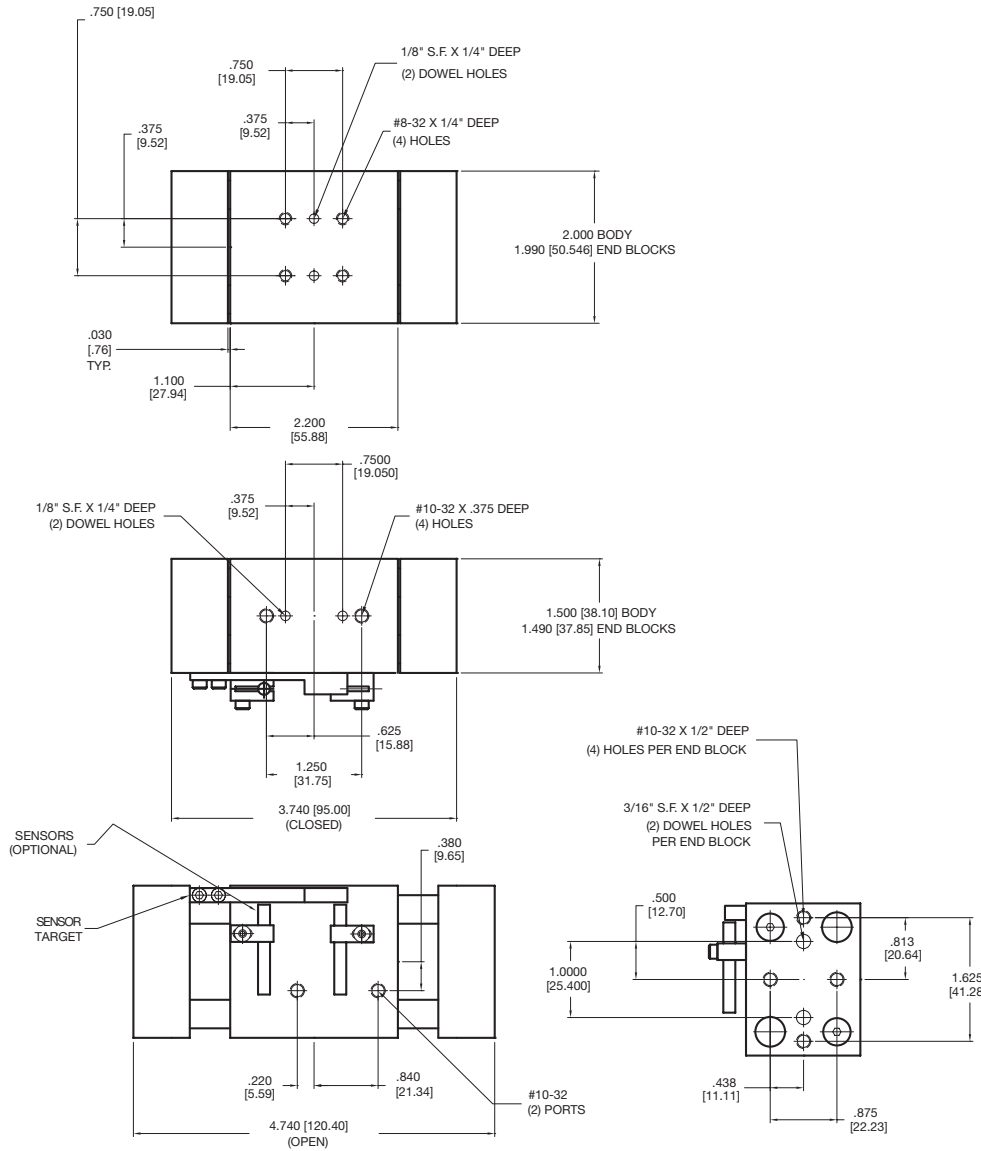

Specifications

Load Capacity	WBGs90
Grip Force @ 80 psi	36 lbs
Stroke	1 in.
Repeatability	+/- 0.002
Operating Temp.	-20°/180°F
Max. Actuation Speed	0.3 sec
Maximum Pressure	120 psi
Unit Weight	1.3 lbs

Static Condition

Load Capacity	WBGs90
C-compression	100 lbs.
T-tension	100 lbs.
Mx	175 in.-lbs.
My	250 in.-lbs.
Mz	175 in.-lbs.

Dynamic Condition

Load Capacity	WBGs90
C-compression	20 lbs.
T-tension	20 lbs.
Mx	35 in.-lbs.
My	50 in.-lbs.
Mz	35 in.-lbs.

WBGs-90

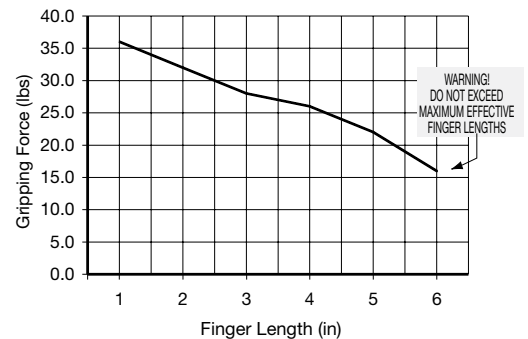

Dimensions: Inches (mm)

WBGL 90 Series

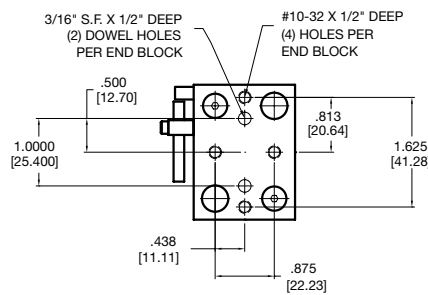
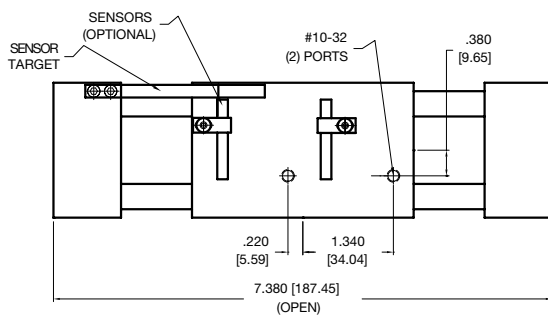
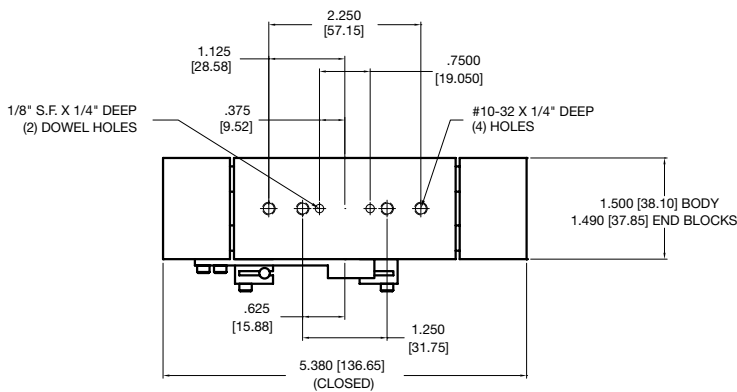
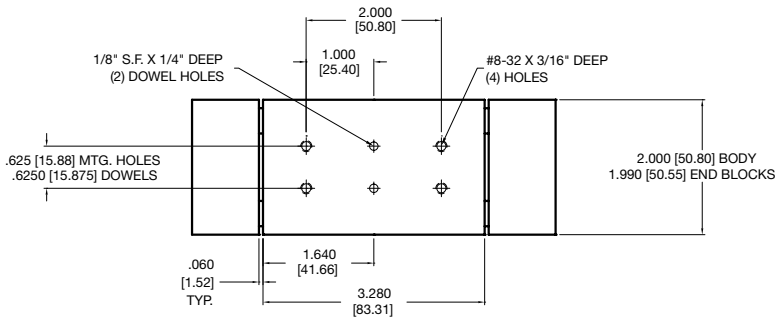

WBGL-90

Specifications

Load Capacity	WBGL90
Grip Force @ 80 psi	36 lbs
Stroke	2 in.
Repeatability	+/- 0.002
Operating Temp.	-20°/180°F
Max. Actuation Speed	0.3 sec
Maximum Pressure	120 psi
Unit Weight	2 lbs

Static Condition

Load Capacity	WBGL90
C-compression	100 lbs.
T-tension	100 lbs.
Mx	175 in.-lbs.
My	250 in.-lbs.
Mz	175 in.-lbs.

Dynamic Condition

Load Capacity	WBGL90
C-compression	20 lbs.
T-tension	20 lbs.
Mx	35 in.-lbs.
My	50 in.-lbs.
Mz	35 in.-lbs.

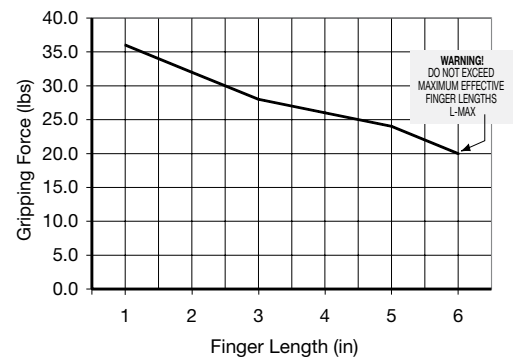

Dimensions: Inches (mm)

WBGX 90 Series

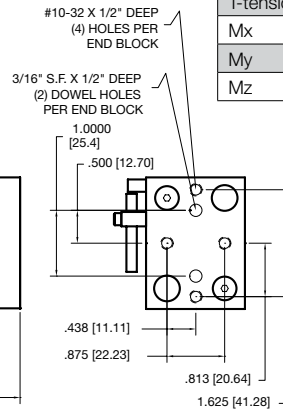
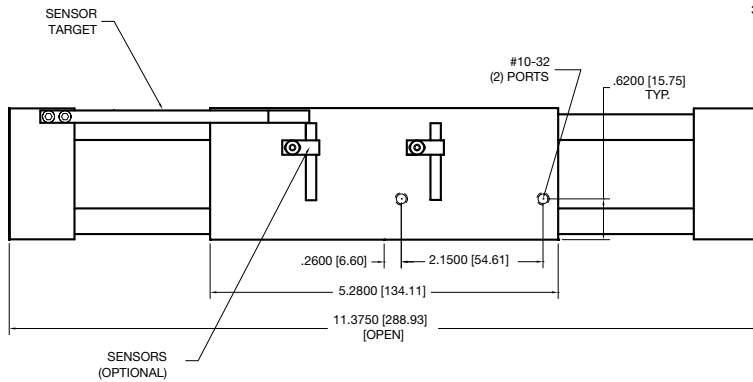
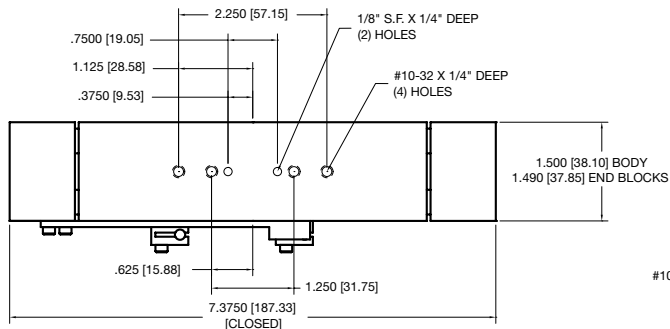
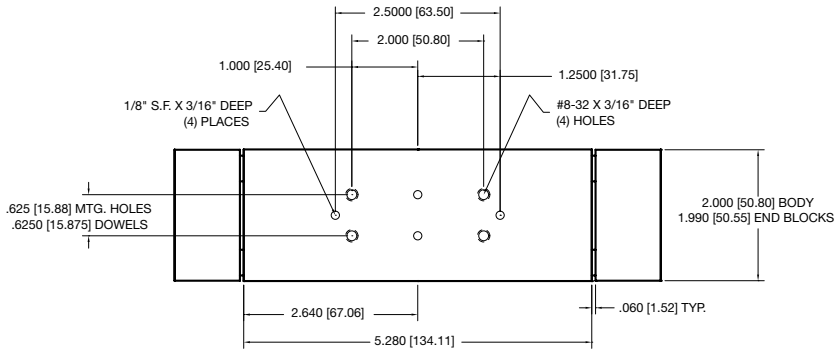

Specifications

Load Capacity	WBGX90
Grip Force @ 80 psi	36 lbs
Stroke	4 in.
Repeatability	+/- 0.002
Operating Temp.	-20°/180°F
Max. Actuation Speed	0.6 sec
Maximum Pressure	120 psi
Unit Weight	3.2 lbs

Static Condition

Load Capacity	WBGX90
C-compression	100 lbs.
T-tension	100 lbs.
Mx	175 in.-lbs.
My	250 in.-lbs.
Mz	175 in.-lbs.

Dynamic Condition

Load Capacity	WBGX90
C-compression	20 lbs.
T-tension	20 lbs.
Mx	35 in.-lbs.
My	50 in.-lbs.
Mz	35 in.-lbs.

WBGX-90

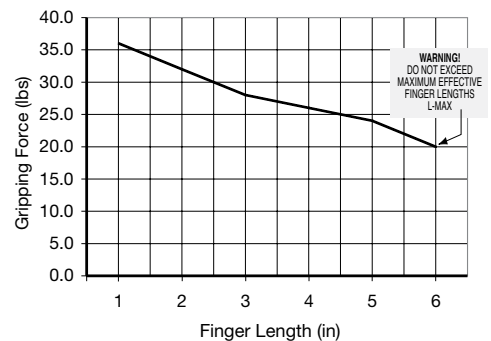

Dimensions: Inches (mm)

WBG S 200 Series

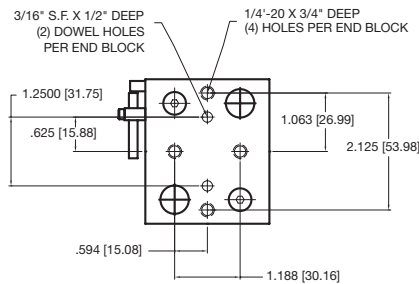
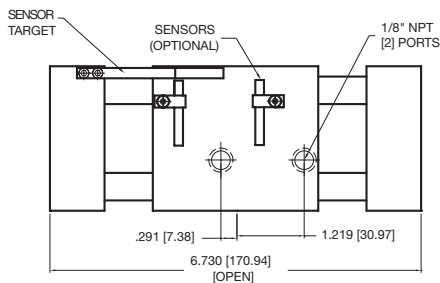
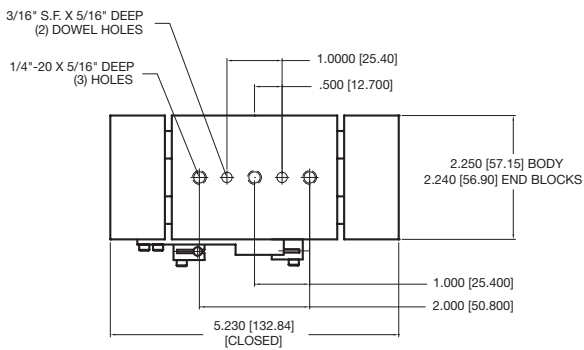
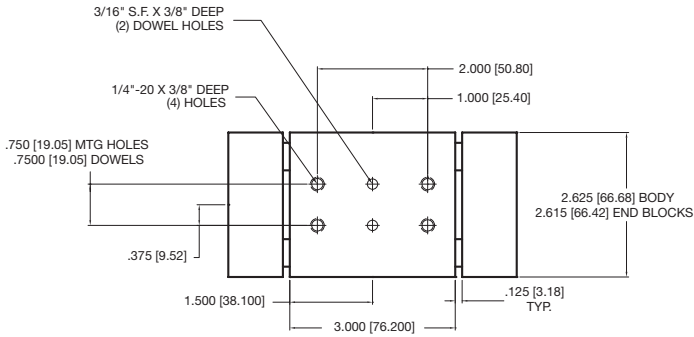

Specifications

Load Capacity	WBG S200
Grip Force @ 80 psi	84 lbs
Stroke	1.5 in.
Repeatability	+/- 0.002
Operating Temp.	-20°/180°F
Max. Actuation Speed	0.3 sec
Maximum Pressure	120 psi
Unit Weight	3 lbs

Static Condition

Load Capacity	WBG S200
C-compression	500 lbs.
T-tension	500 lbs.
Mx	500 in.-lbs.
My	750 in.-lbs.
Mz	500 in.-lbs.

Dynamic Condition

Load Capacity	WBG S200
C-compression	50 lbs.
T-tension	50 lbs.
Mx	50 in.-lbs.
My	75 in.-lbs.
Mz	50 in.-lbs.

WBG S-200

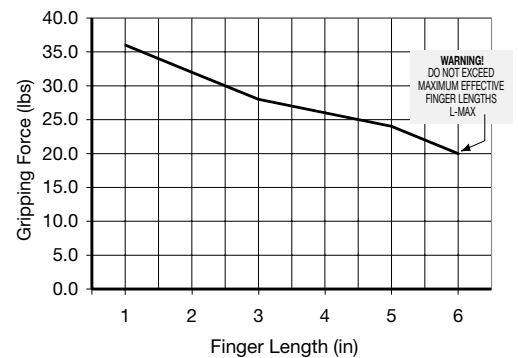

Dimensions: Inches (mm)

WBGL 200 Series

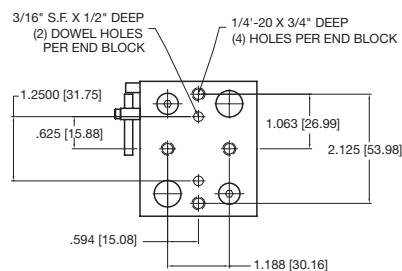
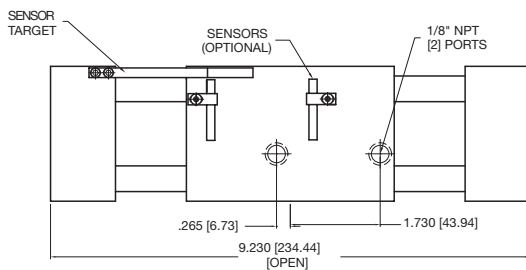
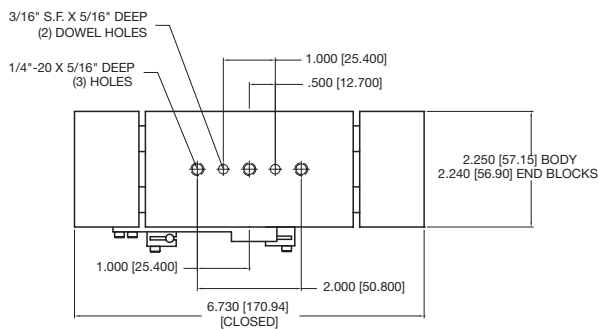
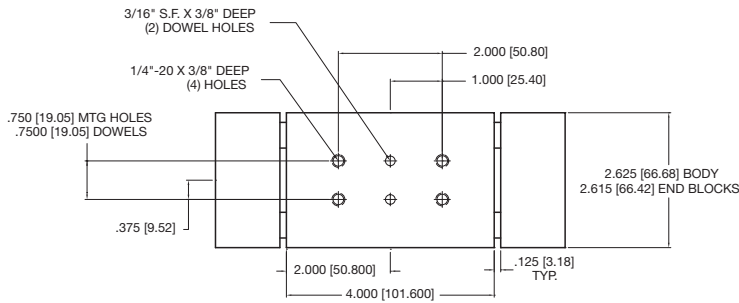

Specifications

Load Capacity	WBGL200
Grip Force @ 80 psi	84 lbs
Stroke	2.5 in.
Repeatability	+/- 0.002
Operating Temp.	-20°/180°F
Max. Actuation Speed	0.3 sec
Maximum Pressure	120 psi
Unit Weight	4 lbs

Static Condition

Load Capacity	WBGL200
C-compression	500 lbs.
T-tension	500 lbs.
Mx	500 in.-lbs.
My	750 in.-lbs.
Mz	500 in.-lbs.

Dynamic Condition

Load Capacity	WBGL200
C-compression	50 lbs.
T-tension	50 lbs.
Mx	50 in.-lbs.
My	75 in.-lbs.
Mz	50 in.-lbs.

WBGL-200

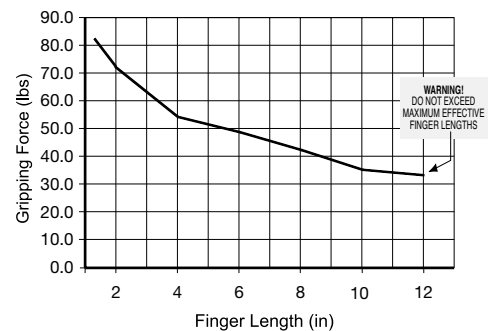

Dimensions: Inches (mm)

WBGX 200 Series

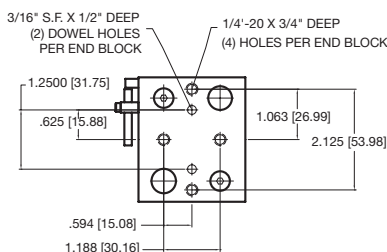
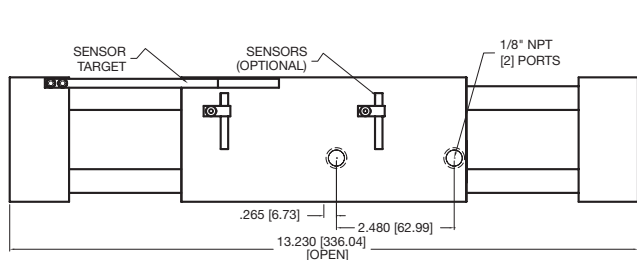
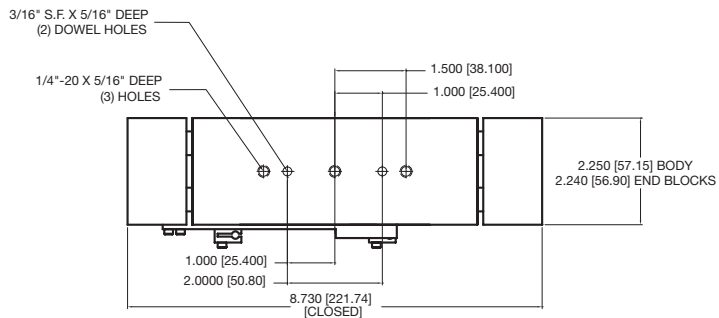
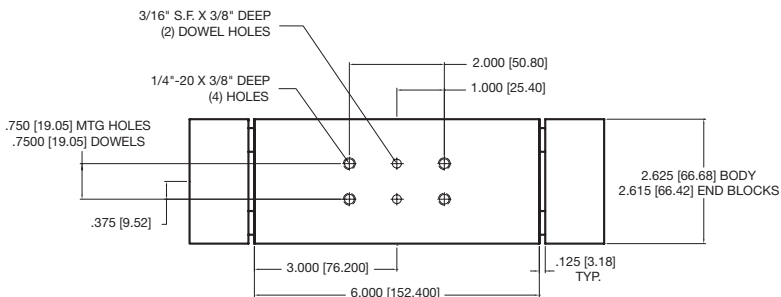

Specifications

Load Capacity	WBGX200
Grip Force @ 80 psi	84 lbs
Stroke	4 in.
Repeatability	+/- 0.002
Operating Temp.	-20°/180°F
Max. Actuation Speed	0.5 sec
Maximum Pressure	120 psi
Unit Weight	6 lbs

Static Condition

Load Capacity	WBGX200
C-compression	500 lbs.
T-tension	500 lbs.
Mx	500 in.-lbs.
My	750 in.-lbs.
Mz	500 in.-lbs.

Dynamic Condition

Load Capacity	WBGX200
C-compression	50 lbs.
T-tension	50 lbs.
Mx	50 in.-lbs.
My	75 in.-lbs.
Mz	50 in.-lbs.

WBGX-200

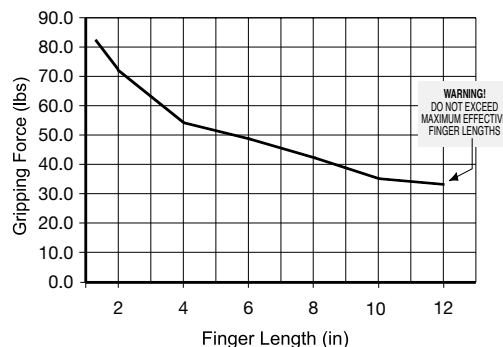

Dimensions: Inches (mm)

WBGs 300 Series

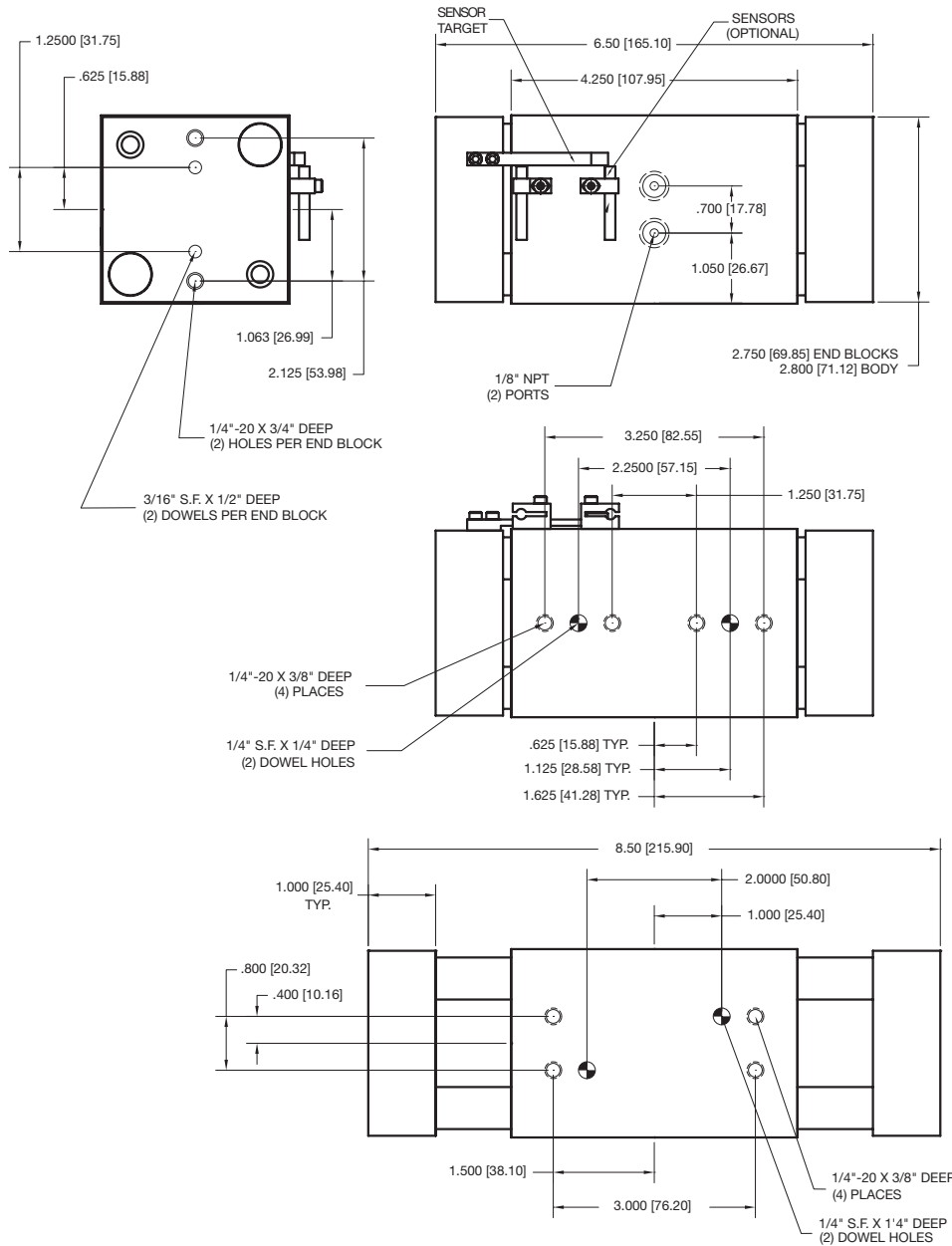

Specifications

Load Capacity	WBGs300
Grip Force @ 80 psi	130 lbs
Stroke	2 in.
Repeatability	+/- 0.002
Operating Temp.	-20°/180°F
Max. Actuation Speed	0.3 sec
Maximum Pressure	120 psi
Unit Weight	6.3 lbs

Static Condition

Load Capacity	WBGs300
C-compression	1300 lbs.
T-tension	1300 lbs.
Mx	1100 in.-lbs.
My	1500 in.-lbs.
Mz	1100 in.-lbs.

Dynamic Condition

Load Capacity	WBGs300
C-compression	150 lbs.
T-tension	150 lbs.
Mx	120 in.-lbs.
My	130 in.-lbs.
Mz	120 in.-lbs.

WBGs-300

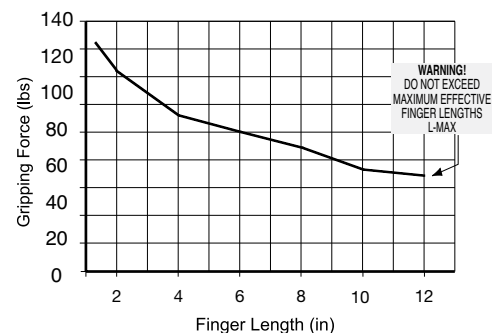

Dimensions: Inches (mm)

WBGL 300 Series

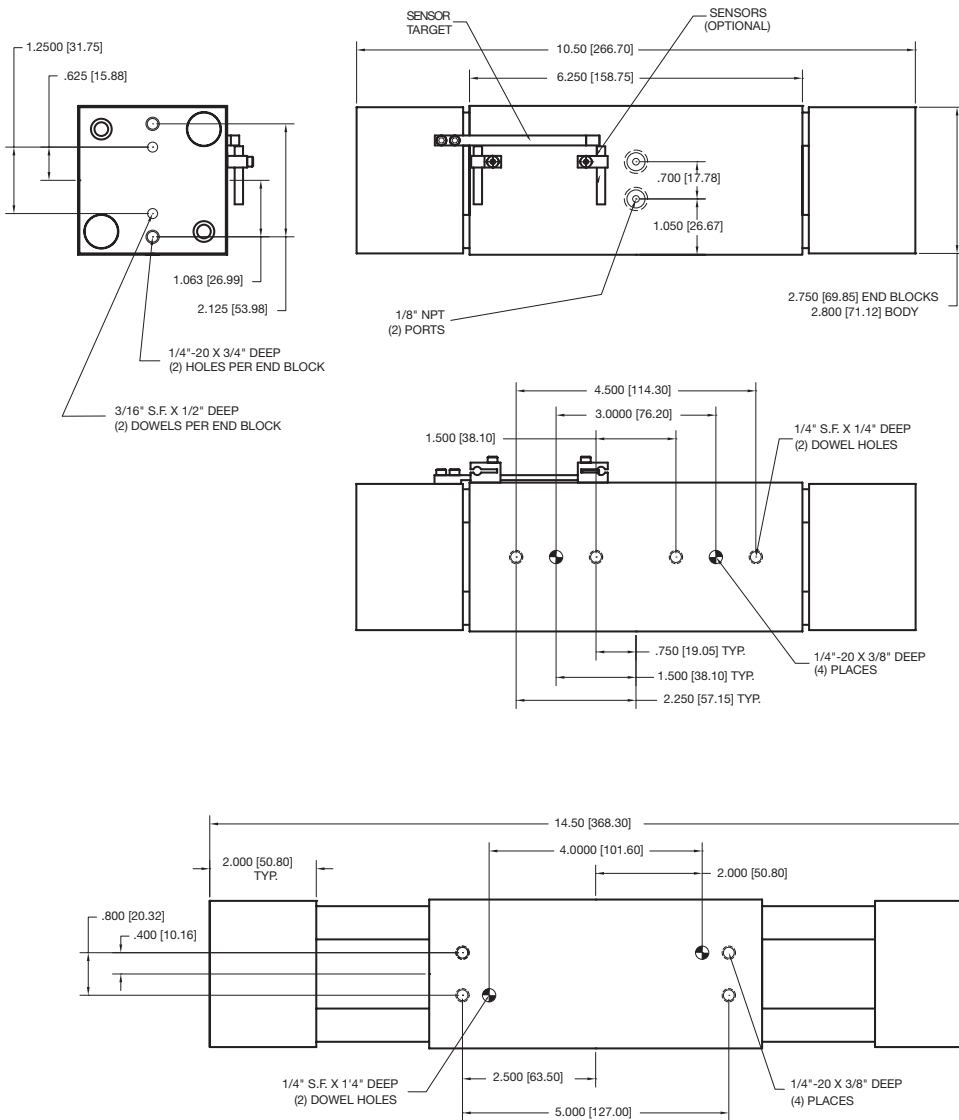

Specifications

Load Capacity	WBGL300
Grip Force @ 80 psi	130 lbs
Stroke	4 in.
Repeatability	+/- 0.002
Operating Temp.	-20°/180°F
Max. Actuation Speed	0.3 sec
Maximum Pressure	120 psi
Unit Weight	8 lbs

Static Condition

Load Capacity	WBGL300
C-compression	1300 lbs.
T-tension	1300 lbs.
Mx	1100 in.-lbs.
My	1500 in.-lbs.
Mz	1100 in.-lbs.

Dynamic Condition

Load Capacity	WBGL300
C-compression	150 lbs.
T-tension	150 lbs.
Mx	120 in.-lbs.
My	130 in.-lbs.
Mz	120 in.-lbs.

WBGL-300

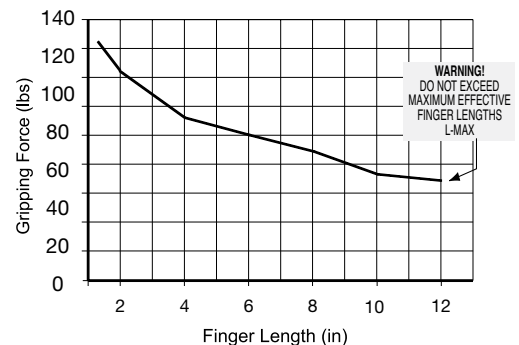

Dimensions: Inches (mm)

WBGX 300 Series

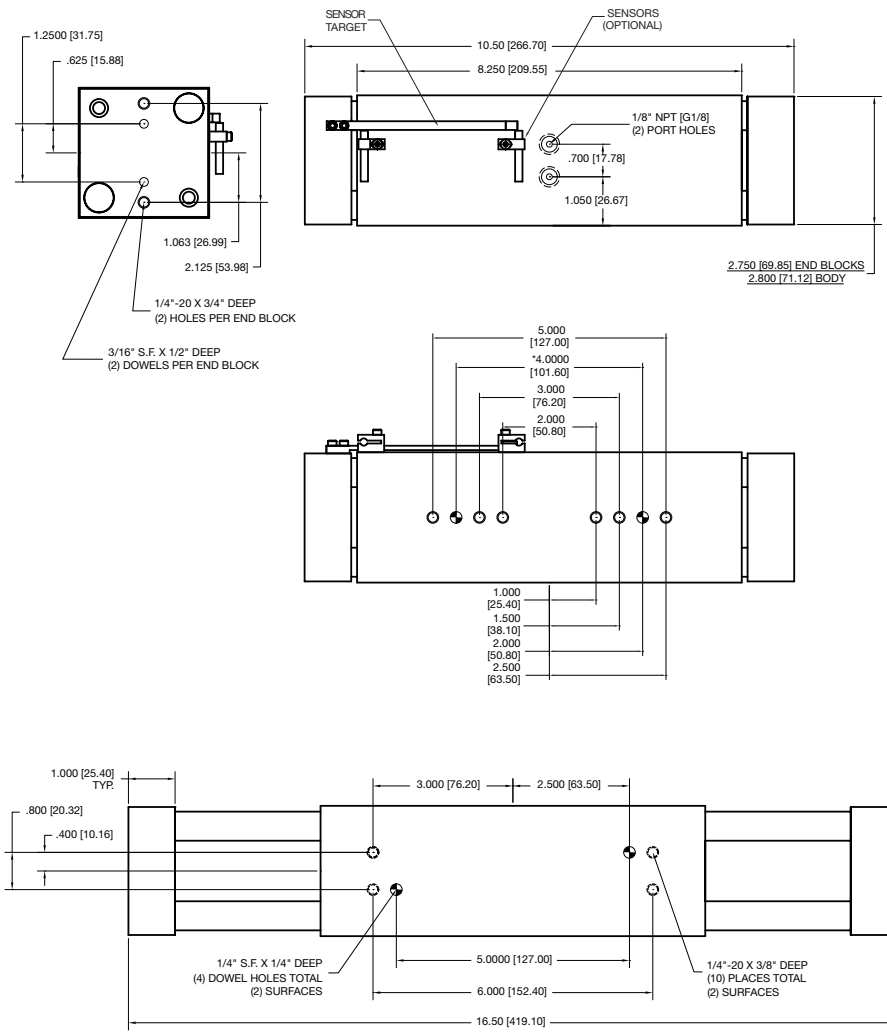

Specifications

Load Capacity	WBGX300
Grip Force @ 80 psi	130 lbs
Stroke	6 in.
Repeatability	+/- 0.002
Operating Temp.	-20°/180°F
Max. Actuation Speed	0.3 sec
Maximum Pressure	120 psi
Unit Weight	9.7 lbs

Static Condition

Load Capacity	WBGX300
C-compression	1300 lbs.
T-tension	1300 lbs.
Mx	1100 in.-lbs.
My	1500 in.-lbs.
Mz	1100 in.-lbs.

Dynamic Condition

Load Capacity	WBGX300
C-compression	150 lbs.
T-tension	150 lbs.
Mx	120 in.-lbs.
My	130 in.-lbs.
Mz	120 in.-lbs.

WBGX-300

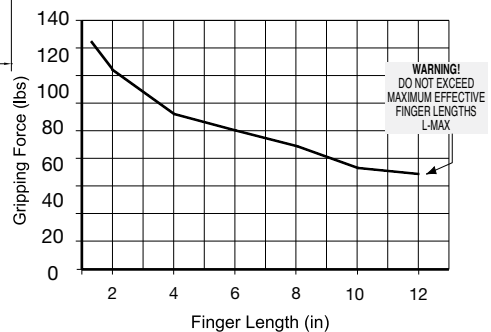

WBG Series Gripper

Bore	Bracket P/N
WBG	CT-500



Sensor Description	Standard Cord Set	Quick Disconnect
Prox PNP	PROX-4FL2-P	PROX-4QDS-P
Prox NPN	PROX-4FL2-N	Not Available

See page 19 for sensor specifications

Prox Switch (NPN NO) Flying Lead - PROX-4FL2-N
Prox Switch (PNP NO) Flying Lead - PROX-4FL2-P

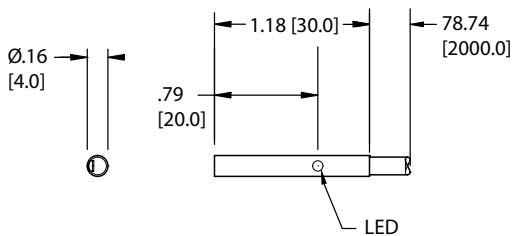

- PNP N/O
 - 1 → BN
 - 4 → BK
 - 3 → BU
 - NPN N/O
 - 1 → BN
 - 4 → BK
 - 3 → BU
- Electrical Design
 Output
 Operating Voltage
 Current Rating
 Short Circuit Protection
 Overload Protection
 Reverse Polarity Protection
 Voltage Drop
 Current Consumption
 Real Sensing Range
 Switching Frequency
 Ambient Temperature
 Protection
 Switch-Point Drift
 Hysteresis
 Operating Distance
 Correction Factor
- Housing Material
 Function Display Switching Status
 Connection

- 3-Wire DC PNP/NPN
 Normally Open
 10-36 VDC
 100 mA
 Yes (Non-Latching)
 Yes
 Yes
 < 2.5V
 < 15 mA @ 24V
 .8mm ± 10%
 > 2000 Hz
 -25°C to 70°C
 IP 65, III
 -10 - 10% OF Sr
 1 - 15% OF Sr
 0 - .65mm
 Mild Steel=1, Stainless Steel=.7,
 Brass=.5, Alum.=.4, Copper=.3
 Housing; Stainless Steel: POM
 Yellow LED
 PVC Cable, 2m, 3 x .14mm2

Prox Switch (PNP NO), 8 mm connector - PROX-4QDS-P

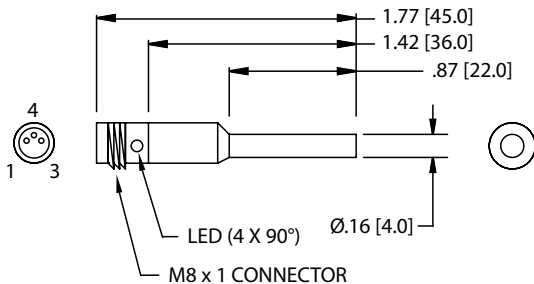

- Electrical Design
 Output
 Operating Voltage
 Current Rating
 Short-Circuit Protection
 Overload Protection
 Reverse Polarity Protection
 Voltage Drop
 Current Consumption
 Real Sensing Range
 Switching Frequency
 Ambient Temperature
 Protection
 Switch-Point Drift
 Hysteresis
 Operating Distance
 Correction Factor
- Housing Material
 Function Display Switching Status
 Connection
 Remarks
 Accessories
 Agency Approvals

- 3-Wire DC PNP
 Normally Open
 10-36 VDC
 100 mA
 Yes (Non Latching)
 Yes
 Yes
 < 2.5 V
 < 15 mA @ 24V
 8mm ± 10%
 > 2000 Hz
 -25°C to 70°C
 IP 67*, III
 -10 - 10% OF Sr
 1 - 15% OF Sr
 0 - .65mm
 Mild Steel=1, Stainless Steel=.7,
 Brass=.5, Alum.=.4, Copper=.3
 Housing: Stainless; POM
 Red LED (4 X 90°)
 M8 Connector
 cULus- Class 2 Source Required
 Mounting Clamp



*Switches are not designed for wet environments. Please see your distributor for additional information.

Quick Disconnect Cables

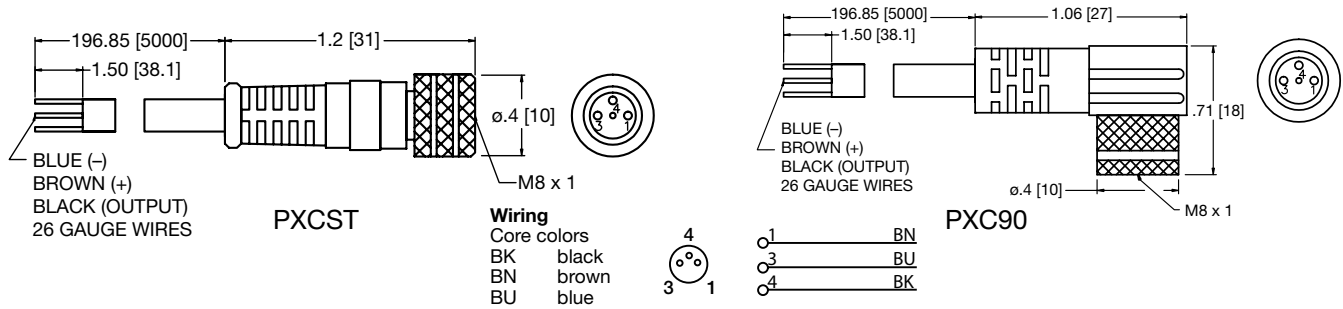

Order Code	Type	Operating Voltage	Current Rating	Cable Material	Protection	Connector
PXCST	Straight 5 m Cable (3 x 26 Gauge wire)	60 AC/75 DC	3 A	PUR	IP 68, III	M8
PXC90	90° 5 m Cable (3 x 26 Gauge wire)	60 AC/75 DC	3 A	PUR	IP 68, III	M8

numatics®

World Class Supplier of Pneumatic Components



World Headquarters

USA Numatics, Incorporated

46280 Dylan Drive
Novi, Michigan 48377

P: 248-596-3200
F: 248-596-3201

Canada Numatics, Ltd

P: 519-758-2700
F: 519-758-5540

México - Ascomatica SA de CV

P: 52 55 58 09 56 40 (DF y Area metropolitana)
P: 01 800 000 ASCO (2726) (Interior de la República)
F: 52 55 58 09 56 60

Brazil Ascoval Ind.e Comercio Ltda

P: (55) 11-4208-1700
F: (55) 11-4195-3970