



MINI-SOLENOID VALVES

intrinsically safe

II 1 G Ex ia IIC T6 to T4 Ga, II 1 D Ex ia IIIC T85°C to T135° IP65 Da
ISO 15218 (CNOMO, size 15) interface
direct operated, pad mounting body, connector size 15

NC



3/2

Series

302

(CFSCIS prefix)

FEATURES

- Mini-low consumption valves (0,5W) for use in potentially explosive atmospheres according to ATEX-Directive 2014/34/EU
- EC type examination certificate (INERIS 03 ATEX 0249X) and IECEx certificate (IECEx INE 10.0002X) are in compliance with the International and European Standards IEC and EN: 60079-0, 60079-11 and 60079-26
- The valve's Ex ia protection allows it to be installed in explosive atmospheres up to zone 0 or 20. It can be used in the chemical, oil and pharmaceutical industries, or in processing and packaging plants for flammable products (paints, solvents)
- Compact, monobloc pilot valve with spade plug. Connection according to DIN 43650, industry standard B, 9,4 mm pin spacing
- Version with integrated display and electrical protection. LED visible from 3 sides

GENERAL

Differential pressure 0 - 8 bar [1 bar = 100 kPa]
Pneumatic base ISO 15218 (CNOMO E06.36.120N, size 15)
Connection Subbase
Response time 20 ms

fluids (*)	temperature range (TS)	seal materials (*)
air or inert gas filtered (50 µm), without condensate, dew point: -20°C	- 10°C to + 40°C	NBR (nitrile) FPM (fluoroelastomer)

MATERIALS IN CONTACT WITH FLUID

(*) Ensure that the compatibility of the fluids in contact with the materials is verified

Body PARA
Internal parts POM, PET, stainless steel and brass
Seals NBR, FPM
Pneumatic interface seal TPE

OTHER MATERIALS

Coil Thermoplastic PET

ELECTRICAL CHARACTERISTICS

Coil insulation class F II 1 G Ex ia IIC T6 to T4 Ga
 II 1 D Ex ia IIIC T 85°C to T135°C IP65 Da

Connector Spade plug (cable Ø 4-6 mm)
Connector specification DIN 43650, 9,4 mm, industry standard B
Electrical safety IEC 335
Electrical enclosure protection Moulded IP65 (size 15) (EN 60529)
Standard voltages DC (=) : 12V - 24V (2)

SAFETY CODE

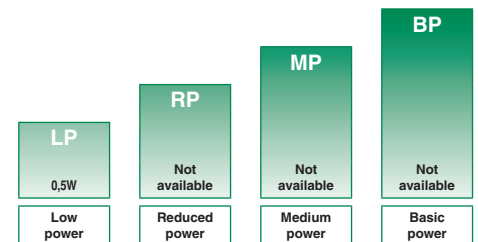

POWER LEVELS - cold electrical holding values (watt)

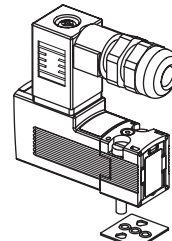

PNEUMATIC CNOMO interface (standard)

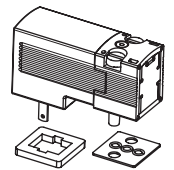

PNEUMATIC-ELECTRIC interface (available on request)

voltage (U _n) (maximum ripple 10%)	power rating (P _n) ^(*) hot/cold =	typical functional ratings					ambient temperature range (TS)	type ⁽³⁾
		I _(ON) min. with LED	U _(ON) min.	U _(MAX) recommended	U _(OFF) turn off	I _(OFF) turn off		
(V)	(W)	(mA)	(V)	(V)	(V)	(mA)	(°C) ⁽¹⁾	
LP1 "12V"	0,5	33	11,9	23	3,3	10	-10 to +40/50/60	01-02
LP1 "24V"	0,5	25	16,4	28	5,7	7		

^(*) Nominal power ratings with LED indicator and electrical protection.

P _n	safety parameters				
	U _i = (DC)	I _i	P _i	L _i	C _i
(W)	(V)	(mA)	(W)	(mH)	(µF)
0,5	28	300	1,6	0	0

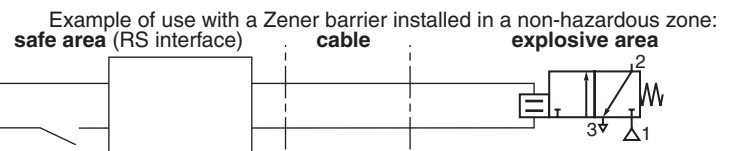

TEMPERATURE CLASSIFICATION TABLE DC (=)

P _i (watt)	maximum ambient °C ⁽¹⁾						insulation class F (155°C) 100% E.D. ⁽²⁾	single solenoid valve solenoid valve mounted in series
	surface temperature							
	T6 85°C	T5 100°C	T4 135°C	12V	24V	12V		
0,5	40	40	50	60	60	60	50	50

⁽¹⁾ Minimum ambient temperature: -10°C

⁽²⁾ Coil designed for permanent duty within maximum ambient temperature limits. The solenoid valve must be connected to a special certified electrical supply unit installed in a non-dangerous zone. List of safety barrier manufacturers on the following page.

⁽³⁾ Refer to the dimensional drawings on page 4.

SPECIFICATION

pipe size	flow		coefficient Kv		operating pressure differential (bar)		power level	basic catalogue number
	at 6 bar l/min (ANR)				min.	max. (PS)		with impulse /maintained manual operator
(mm)	1 → 2	2 → 3	1 → 2	2 → 3		(=)	(=)	=
3/2 NC - normally closed								
0,6	11	20	0,21	0,44	0	8	LP	30215106IAD

When ordering, please specify in addition to the basic catalogue number:

- voltage, 12 V DC or 24 V DC

Examples: with connector DIN 43650, 9,4 mm: **30215106IAD** 12V DC

with connector DIN 43650, 9,4 mm: **30215106IAD** 24V DC

OPTIONS

- Solenoid valves without LED and electrical protection

INSTALLATION

- The solenoid valves can be mounted in any position without affecting operation
- Solenoid valve supplied with mounting screws and mounting pad seal(s)
- Electrical connection between solenoid valve and barrier/interface with cable type A or B according to EN 50039
- Installation on single subbase (3 x M5), brass body, catalogue number **30300001**
- Versions with spade-plug connector type ISO 15217/DIN 43650 form C with 8 mm spacing or M12 connection: contact us
- Installation/maintenance instructions are included with each valve

See the list for compatible interfaces and barriers.

This list is for reference only and the user must take into account the cables and the actual supply voltages for the barriers.

The operating conditions are calculated as follows:

12 V or 24 V with LED :

$$I_1 \text{ (mA)} = \frac{[V_s - 1,2 - 0,003 (R_b + R_1)] \times 1000}{(R_c + R_1 + R_b)} + 3$$

This value (I_1) and the maximum barrier/interface current (if it is non-linear) must be greater than 33 mA (12 V with LED), 25 mA (24 V with LED).

I_1 (mA) Min. supply current of the product

R_b (Ω) Max. barrier resistance

T_a ($^{\circ}\text{C}$) Max. ambient temperature

R_1 (Ω) Max. resistance of connecting cables

V_s (V) Min. no-load voltage of barrier/interface

R_c (Ω) Max. coil resistance:

$$12 \text{ V with LED} = \frac{288 (T_a + 234 + 10)}{254} \quad / \quad 24 \text{ V with LED} = \frac{563 (T_a + 234 + 10)}{254}$$

COMPATIBLE BARRIERS AND INTERFACES

The 12 V DC and 24 V DC solenoid valves are compatible with the barriers listed in the table below. The index (1) indicated the 12 V DC versions that are compatible with the 24 V DC barriers.

Located in safe areas, these barriers and interfaces allow to feed the intrinsically safe solenoid valves located in explosive areas. This equipment must be ordered from its respective manufacturers, specifying that they are intended to feed intrinsically safe solenoid valves: 302 1. ...IA., II 1 G Ex ia IIC T6 to T4 Ga, II 1D Ex ia IIIC T85°C to T135°C IP6X Da

INTERFACES			
manufacturer	module type	302 Ex ia IIC	
		12 V with LED	24 V with LED
ABB	DO910S	x	x
AP3	NAEV30-DO2C-A230-0	x	
	NAEV30-DO2C-A115-0	x	
	NAEV30-DO2H-C024-0	x	
	NAEV30-DO4H-C024-0	x	
	NAEV30-DI2-DO1C-A230-0	x	
	NAEV30-DI2-DO1C-A115-0	x	
	NAEV30-DI2-DO1H-C024-0	x	
Bartec	07-7331-2105/1000	x	
	07-7331-2301/1100	x	
CEAG	LB-2101		
	LB-2103		
	LB-2105	x	
	LB-2112	x	x
	FB-2201		
	FB-2203	x	
	FB-2205	x	
G.M. international	D1040Q-2	x	
	D1042Q-2	x	x
	D1043Q-2	x	
MTL	815-DO-04	x	x
	4021S	x	
Pepperl + Fuchs	KFD2-SD-Ex1.17	x	
	KFD2-SD-Ex1.36	x	x
	KFD2-SD-Ex1.48	x ⁽¹⁾	
	KFD2-SD-Ex1.48.90A	x ⁽¹⁾	
	KFD2-SL-Ex1.48	x ⁽¹⁾	
	KFD2-SL-Ex1.48.90A	x ⁽¹⁾	
	KFD2-SL2-Ex1	x ⁽¹⁾	x
	KFD2-SL2-Ex1.B	x ⁽¹⁾	x
	KFD2-SL2-Ex1.LK	x ⁽¹⁾	x
	KFD2-SL2-Ex2	x ⁽¹⁾	x
	KFD2-SL2-Ex2.B	x ⁽¹⁾	x
	KFD2-VD-Ex1.1560	x	
	KFD2-VD-Ex1.1835	x	x
Stahl	9475/12-04-11	x	
	9475/12-04-21	x	x
	9475/12-04-31	x	
Turck	MK72-S01-Ex	x	
	MK72-S09-Ex0/24VDC	x	
	MK72-S10-Ex0/24VDC	x	
	MC72-41Ex-T/24VDC	x	
	MC72-42Ex-T/24VDC		x
	MC72-44Ex-T	x	
Siemens	MC72-43Ex-T		x
	ET2001S double	x	x
	6ES7132-7RD20-OAB0	x	

Not compatible

⁽¹⁾ Compatible with 24 V DC

ZENER BARRIERS			
manufacturer	module type	302 Ex ia IIC	
		12 V with LED	24 V with LED
CEAG	SB-3722	x	
	SB-0722		
	SB-2420	x	x
	SB-3729	x	x
	SB-3728	x	x
	SB-0728	x	
MTL	MTL 722	x	
	MTL 728	x	x
	MTL 728P	x	x
Pepperl + Fuchs	MTL 779	x	x
	Z728	x	x
	Z728.H	x	x
Stahl	Z728.CL	x	x
	9001/01-199-150-101	x	
	9001/01-280-075-101		
	9001/01-280-085-101	x	x
	9001/01-280-100-101	x	x
EMERSON	9001/01-280-110-101	x	x
	DELTA V		x

For other compatible barriers and interfaces, please ask our product support.

In accordance with the zone classification and the national legislation of each country, apply the certification procedures for the connection of IS-rated products with associated equipment. All information subject to change without notice. All responsibility for the use of products from other suppliers and the possible modifications of their characteristics is disclaimed.

DIMENSIONS (mm), WEIGHT (kg)



TYPE 01:
 302 pilot (CFSCIS)
 Polyarylamide
 IEC 335 / DIN 43650 or ISO 15217
 EN/IEC 60079-11/26

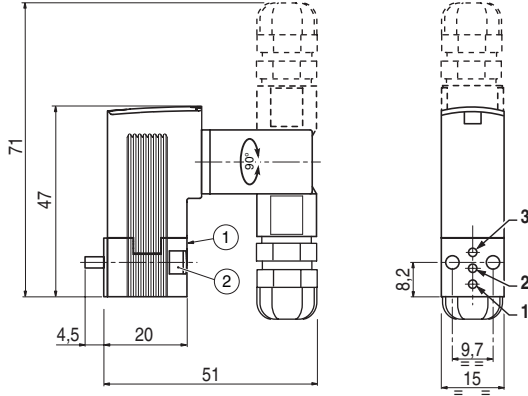

Pneumatic base: ISO 15218
 (CNOMO E06.36.120N, size 15)

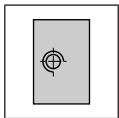
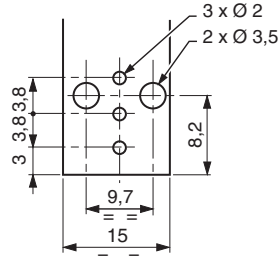

Single subbase
 Brass

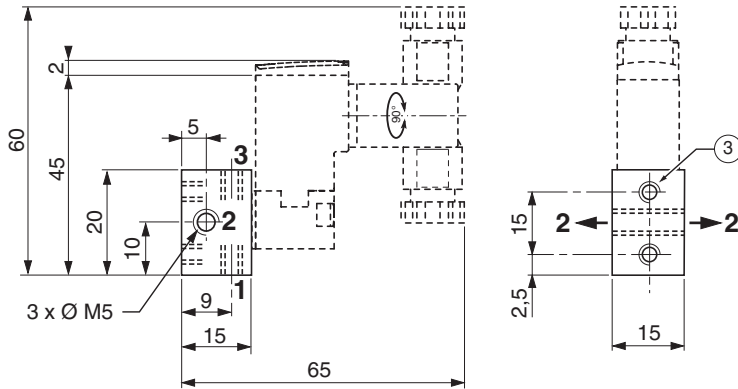

③ Mounting: 2 holes M3, depth 4,5

Orifice (2) can be connected on the left or on the right of the subbase.

material	catalogue number	weight ⁽¹⁾
brass	30300001	0,034

⁽¹⁾ subbase alone