



1100 Series **Magnetic Level Indicators**

with
vistaTM
200° VIEWING ANGLE
indicator



The **VIEW**
Matters

■ Table of Contents



Features and Benefits _ _ _ _ _	3
Complete Level Solution _ _ _ _ _	4
Principals of Operation _ _ _ _ _	5
Industries and Applications _ _ _ _ _	5
Design Attributes _ _ _ _ _	6
Specifications _ _ _ _ _	7
How to Order _ _ _ _ _	8
Auxiliary Products _ _ _ _ _	12
Application Data Sheet _ _ _ _ _	13



1100 Series Magnetic Level Indicator

The 1100 Series Magnetic Level Indicator (MLI) is a proven method to simplify measuring liquid levels. Not only does the 1100 Series give a visual indication, it also eliminates the need for armored sight glass instruments - simplifying piping systems and allowing for multiple measurements without unnecessary complications to the piping.

Industry Leading Indicator Design

The 1100 Series Magnetic Level Indicator is the most accurate and reliable gauge available. Including one of the widest, most visible indicating flag designs in the industry, the 1100 Series magnetic level indicator can easily be read at a distance of 250 feet (76 meters) or more - *best in the industry*.

Decades of Chamber Design Experience

Not only does the 1100 Series provide the best visual indication in the world, we've also coupled our new float and indicator design with the SOR tried-and-true chamber design that was developed through years of experience and innovation. SOR has countless instrument chambers installed around the world that have been providing reliable service for more than 4 decades.

Along with one of the largest product portfolios in the industry, SOR has been able to blend all of these features to bring to you the easiest and most economical way to measure and control liquid levels in any application.

- Patented *vista* indicator with 200° viewing angle (U.S. Pat. No. 14/638,990)
- Forward viewing distance of 250 feet (76 meters) or more
- Chambers designed to ASME codes B31.1 and B31.3 guidelines (certified with CY & CZ option)
- Schedule 40 316/316L stainless steel construction standard, Schedule 80 and other materials available
- ASME Section IX and AWS qualified welding process
- Full penetration welds with no extruded outlets (certified with CY & CZ option)
- No pressurized floats
- High visibility reflective scale
- 316 SS flanges standard
- Full hydro test of floats @ 1.5 MAWP
- Interface detection capability
- NACE and CRN certifications available
- Dimensional drawings available at quotation
- Quick delivery
- Dependable operation for years of service
- 5 year warranty*

SOR is the best partner to make your design easier.

**1 year warranty for Model 1140 and Indicator*

■ Complete Level Solution

SOR makes it easy for you to find your complete level solution all from **one** supplier.

- No need to source parts from many different vendors
- No concern about everything fitting and operating together
- No issues with delivery time

ONE SOURCE. ONE SOLUTION. ONE CALL

With SOR, the solution is available from us – one source. You don't have to worry about everything fitting and operating together. All you have to do is select a magnetic level indicator, point level switch, magnetostrictive level transmitter or a guided wave radar that are designed to work seamlessly together to provide one of the most reliable solutions in the industry.

SOR One of the Best Machine Shops in America.

Our manufacturing facilities include more than 85,000 square feet of vertically integrated production capability and we are proud of having our Lenexa machine shop voted one of the



top 10 in the United States by the American Machinist magazine. With decades of experience manufacturing floats and chambers, we have designs for thousands of unique applications around the world, including high pressure, high temperature and interface.

SOR is also dedicated to reducing product lead times and has LEAN initiatives in place to continuously improve the quality and delivery of products we provide to you. Just

make one call to our customer service team and they will get you the answers you need.



Principals of Operation

The 1100 Series Magnetic Level Indicator provides visual indication of liquid level within a larger, primary process vessel.

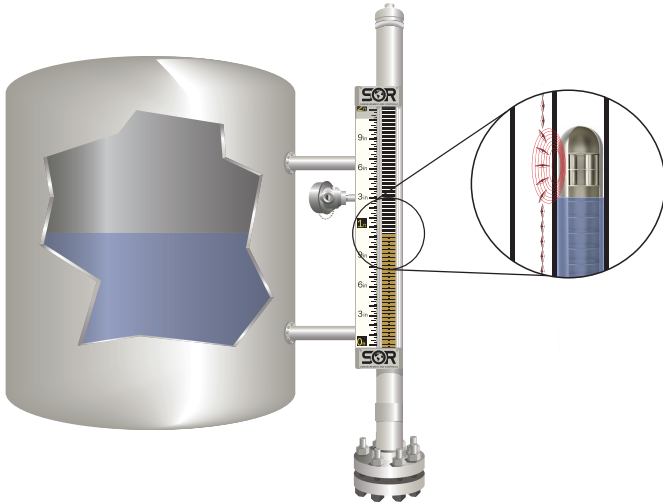

- Once the MLI is mounted to the process vessel via the supplied process connections, the process liquid will flow freely up and down within the MLI chamber.
- A specially designed float is located inside the 1100 Series chamber and floats along with the process level. This float contains a powerful magnet that interacts with the non-invasive indicator assembly located on the outside of the chamber. This magnetic coupling between the float and the indicator allows the process level to be shown via the use of rotating flags housed inside the assembly.
- As the level rises and falls, these flags will change color and provide real time indication of the liquid level within the primary process vessel. The float will also interact with any attached switches or transmitters, supplying additional signal input to your control system.

Industries and Applications

1100 Series Magnetic Level Indicators are suitable for most industrial and commercial applications.

Chemical and petrochemical industries

- Refined products
- Heat transfer fluids
- Solvents
- Acids and caustics

Power generation

- Boilers
- Feed water heaters
- Sight glass replacement

Oil and gas industries

- Offshore production
- Compressor packages
- Oil and water interface
- High and low pressure separators
- Gas condensate
- Glycol

Other

- Pulp and paper
- Food and beverage
- Pharmaceutical
- Industrial chemicals
- Waste water



Design Attributes

Basic Construction

- Highly configurable to meet the installation requirements of older tanks
- Schedule 40 316/316L stainless steel construction standard, Schedule 80 and other materials available
- Designed to ASME B31.1 and B31.3 guidelines (certified with CY & CZ option)
 - NACE option available

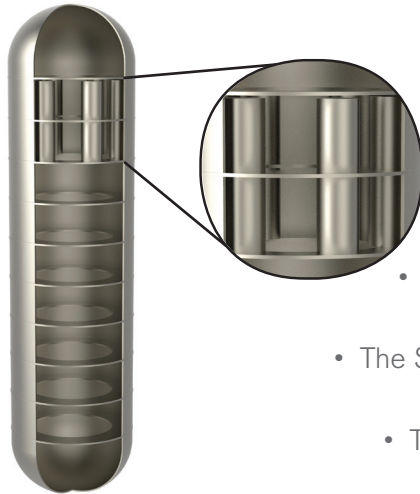

Standard Float Construction

- The SOR float sectional design has the strongest magnet pack available
- Each float is custom designed to meet the process temperatures, pressures and specific gravities
- The SOR float has been engineered to provide the most reliable float and indicator combination available
- The state-of-the-art sectional design, allows SOR to exceed the functional limits of traditional floats
- The SOR design is fully compatible with auxiliary equipment

Indicator

- SOR has designed and developed the patented vista indicator which provides the widest viewing angle in the industry (U.S. Pat. No. 14/638,990)
 - Lateral viewing angle of 200°
 - Forward viewing distance 250 feet (76 meters) or more
- The vista indicator is a unique innovation that provides the easiest, most reliable viewing of any indicator available
 - A wide variety of indicator flag colors are available

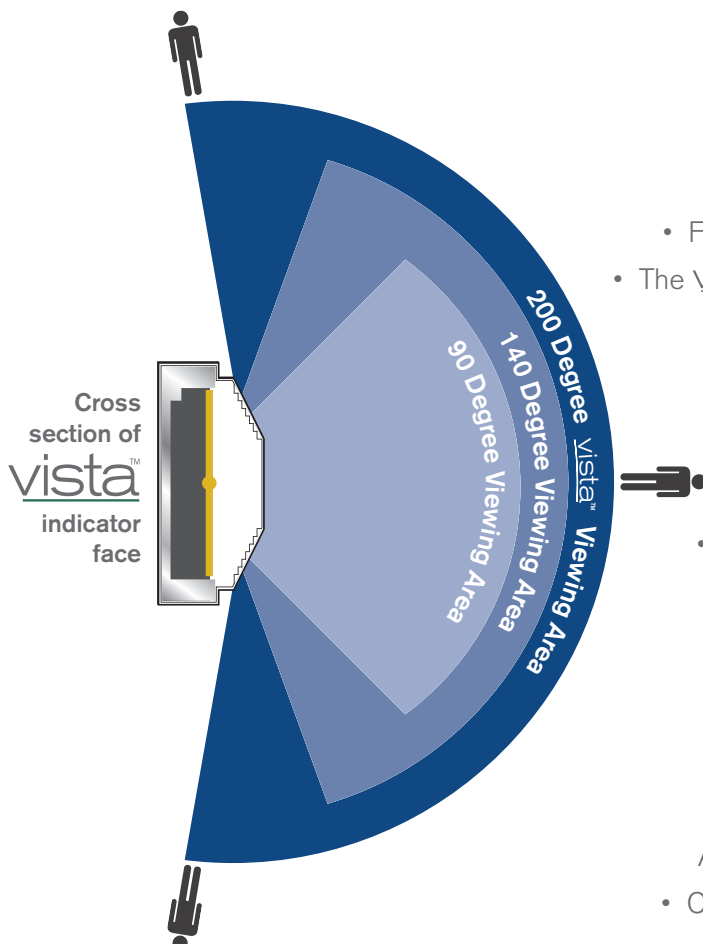

Measurement Scales

- Standard scales have a higher reflectivity index and excellent environmental resistance
- Optional stainless steel, laser etched scales available
- Scales are available in English and Metric units
 - Custom scales with volumetric or percentage units are available upon request

Process Connections

- Full penetration welds available
 - Welds are designed and manufactured to ASME B31.1 and B31.3 guidelines with CY & CZ option
- Outlets designed to ASME B31.1 and B31.3 guidelines (certified with CY & CZ option)
 - No extruded Outlets

Process Capabilities

- Pressure: Full Vacuum to 5000 psi (345 bar)
- Temperature: -320°F to 1000°F (-196°C to 538°C)
- Minimum Specific Gravity: 0.35
- Minimum Interface Difference: 0.03 in specific gravity

Materials of Construction

- Chamber: 304L, 316/L, 317, 321, 347 SS, Hastelloy B or C, Alloy 20, Titanium, Inconel 625 and other materials available upon request
- Float: 316SS, Titanium or Monel

Indicators

- Standard indicator: yellow/black, custom colors available upon request

Glass | Max Temperature: 1000°F (538°C)
Viewing Angle: 140°

Polycarbonate | Max Temperature: 450°F (232°C)
Viewing Angle: 140°

vista™ | Material:
UV protection
infused polycarbonate
Max Temperature: 450°F (232°C)
Viewing Angle: 200°

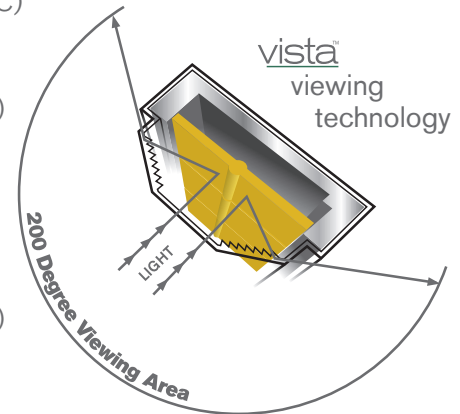

Switch Specifications

- SPDT, DPDT point level switches with high temperature housings available
- Agency listed explosion proof enclosures with terminal blocks available

Measuring Ranges

- Standard ranges from 6 in. (15.24 cm) to 19 ft. (5.79 m).
For ranges larger than this, multiple units can be stacked.
- Custom ranges available

Testing and Documentation

- Radiographic Examination
- Liquid Dye Penetrant Examination
- Hydrostatic Examination
- Positive Material Identification Certification
- ASME B31.1, B31.3
- PED Certification available with 1140 model
- NACE MR0103, NACE MR0175
- CRN

Accessories

- Electrical Heat Tracing
- Steam Heat Tracing
- Flashing & Boiling Protection
- Non-destructive Test Certificates
- Vent & Drain Valves
- Insulation Blankets

Auxiliary Products

- Point Level Switches
- Magnetostrictive Transmitters
- Differential Pressure Transmitters
- Guided Wave Radar Transmitters

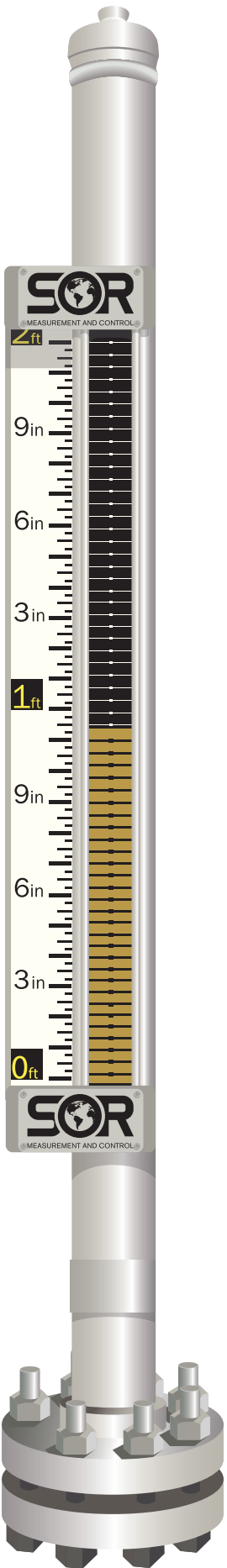

How to Order

Below is the SOR quick select model number tree that provides you with all of the options to configure and order a product for your application.

- You must select a designator for each component
- Reference tables, charts and additional information is provided throughout the catalog to help you make your selections, see pages noted in the tree

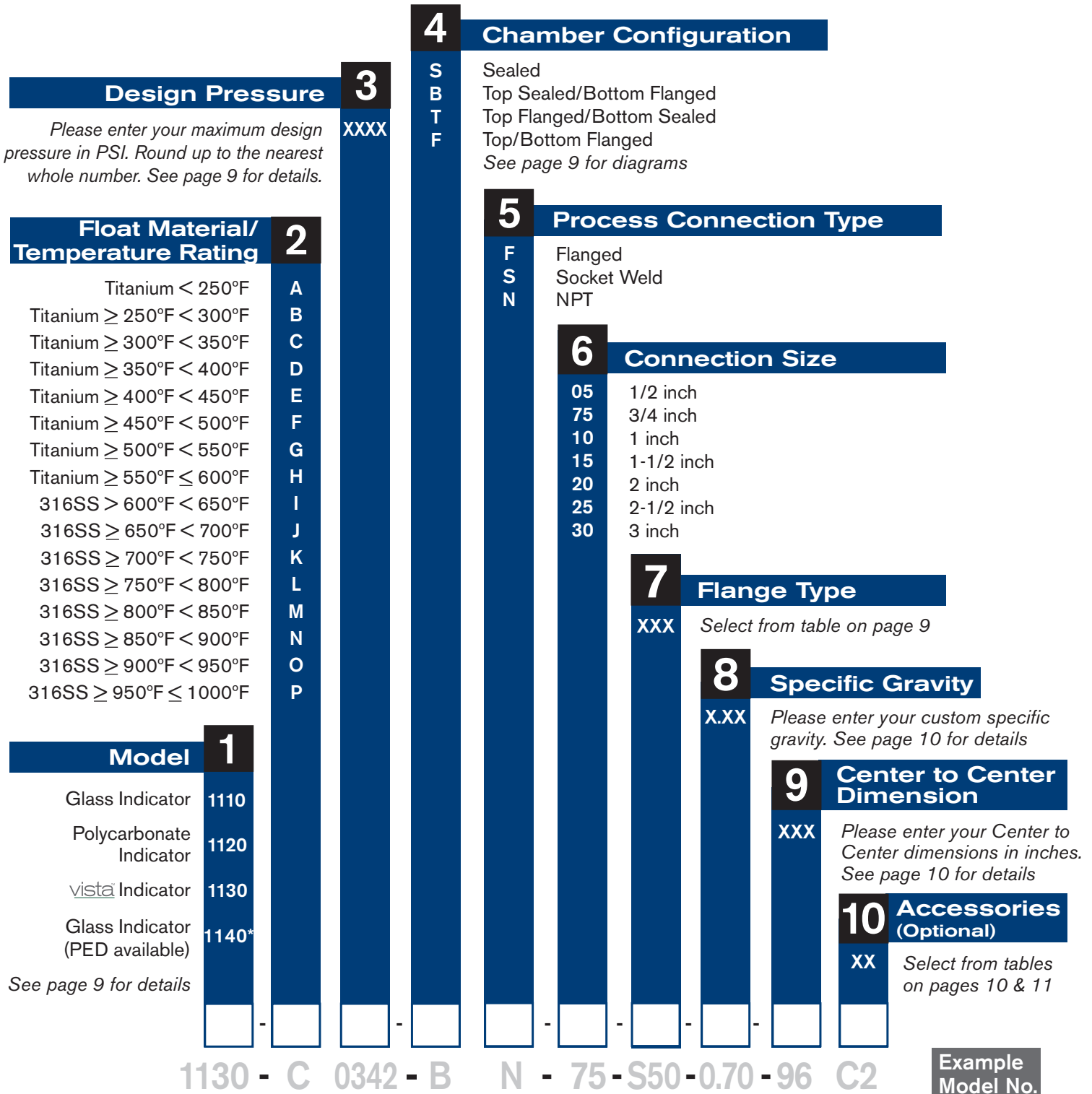

*Model 1140 to be shipped through our manufacturing partner. PED certification (PD option) only available on 1140 model. Vista indicator on 1140 model available upon request

Step 1: Model

1130-C 0342-B N 75-S50-0.70-96-C2

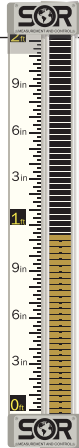

SOR offers three indicators: the traditional glass indicator, an impact resistant polycarbonate and the cutting edge vista design. Select the indicator that best suits your needs.

	1110 and 1140 Glass	1120 Polycarbonate	1130 <u>vista</u>
Max temperature	1000°F (538°C)	450°F (232°C)	450°F (232°C)
Viewing angle	140°	140°	200°

Note: Standard indicator flag colors are black and yellow. Custom colors available upon request.

Step 3: Design Pressure

1130-C 0342-B N 75-S50-0.70-96-C2

Please enter your max design pressure in psi. Round up to nearest whole number. To enter max pressure in BAR, select the MC accessory option. Example: If max design pressure is 341.2 psi, enter the value 0342.

Step 4: Chamber Configuration

1130-C 0342-B N 75-S50-0.70-96-C2

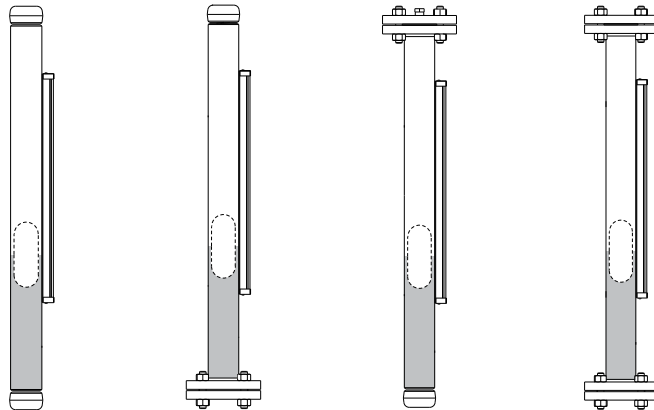

The 1100 Series is offered with side/side process connections as a standard. The 1100 Series can be configured to meet your application needs. Inquire about the many options available.

S	B	T	F	Designator
Top Sealed/ Bottom Sealed	Top Sealed/ Bottom Flanged	Top Flanged/ Bottom Sealed	Top Flanged/ Bottom Flanged	Configuration

Step 7: Flange Type

1130-C 0342-B N 75-S50-0.70-96-C2

Select a flange type and rating from the table below. This selection will determine the flange type and rating for flanges on top and bottom of the chamber as well as the process connections.

Note: If the chamber configuration is sealed and the process connection type is socketweld or NPT, please select the corresponding designator. }

Socketweld	SCW
NPT	NPT

Flange Type	ANSI Class	Designator	Flange Type	ANSI Class	Designator
Slip-on	150#	S50	Weldneck	150#	W50
	300#	S30		300#	W30
	600#	S60		600#	W60
	900#	S90*		900#	W90*
	1500#	S15*		1500#	W15*
	1500 RTJ	S1R*		1500 RTJ	W1R*
	2500#	S25*		2500#	W25*
	2500# RTJ	S2R*		2500# RTJ	W2R*

*Options may change specifications and dimensions, contact customer service for more information.

Step 8: Specific Gravity Value

1130-C 0342-B N 75-S50-0.70-96-C2

Each float is custom designed to operate to your specifications. To help identify each units capabilities, we've configured the specific gravity into the model string and mark each float with its specifications. Please enter your custom specific gravity.

Note: Minimum available specific gravity is 0.35.

Step 9: Center to Center Dimension

1130-C 0342-B N 75-S50-0.70-96-C2

Every magnetic level indicator is customized to match your required dimensions. Please enter your center to center dimension in inches of the process connections.

Note: Standard center to center dimensions are 6 inches to 228 inches (19 feet).

Step 10: Accessories

1130-C 0342-B N 75-S50-0.70-96-C2

SOR accessories are provided for customizing the magnetic level indicator. Place accessory designator(s) from the table at the end of the model number.

Accessory	Description	Designator
 Insulation Blanket	Insulation is recommended when indicators are to be used under extreme temperature conditions. Factory installed, removable insulation blankets are available in two configurations. <ol style="list-style-type: none"> The standard blanket is for temperatures to 500°F (260°C) and consists of a 2 inch thick (compressed to 1"), 6# Cer-Wool HP enclosed in 3201-2-SS silicone coated fiberglass cloth. For operating temperatures above 500°F (260°C), fiberglass material rated to 1100°F (593°C) is included on the contact surface of the blanket. 	BL
Steam Heat Tracing*	A wide variety of heat tracing options are available. Heat tracing can be used for freeze protection or to maintain the process temperature of molten materials. Heat tracing is engineered to customer specifications and can be provided with controllers.	ST
Electrical Heat Tracing*		TR

Accessory	Description	Designator
NACE MR0175	Compliance to NACE Certification MR01-75/ISO 15156, NACE MR0103	NC
Metric Dimensions	Model number center-to-center dimensions are in metric units (cm)	MC
Custom Etched 316SS Scale	Scale can be marked to your specific requirements. For example, metric units, percent, etc.	CS
Flashing Boiling Protection*	If a process can flash or boil, your level gauge needs to be protected from float damage. This is accomplished by using an oversized chamber and an insert that keeps the float aligned with the indicator. The flashed gasses will escape around the float, preventing high velocity damage. The SOR design has a non-welded insert that clamps between the chamber flanges, allowing the insert and indicator to be rotated for maximum viewing in tight installations.	FB
Special Configuration	"X" is used as a suffix to the model number for special requirements not keyed elsewhere in the model number by an "X". Each "X" must be identified in the text of the order or inquiry.	X



Accessory	Type	Size		Designator	
Vent Connection	NPT	1/2"	Valve	V1**	
			No Valve (plugged)	P1	
		3/4"	Valve	V2**	
			No Valve (plugged)	P2	
		1"	Valve	V3**	
			No Valve (plugged)	P3	
	SW	1/2"	Valve	V4**	
		3/4"	Valve	V5**	
		1"	Valve	V6**	
Drain Connection	NPT	1/2"	Valve	W1**	
			No Valve (plugged)	Q1	
		3/4"	Valve	W2**	
			No Valve (plugged)	Q2	
		1"	Valve	W3**	
			No Valve (plugged)	Q3	
	SW	1/2"	Valve	W4**	
		3/4"	Valve	W5**	
		1"	Valve	W6**	
	Test Certificate	Hydro Test Certificate			C2
		Inspection Report			C3
		QA Test Report			C7
Certificate of Conformance (power plant piping ASME 31.1)			CY		
Certificate of Conformance (petrochemical plant piping ASME 31.3)			CZ		
Ultrasonic Examination			UP		
Mill Test Report			MR		
PED Certification (only available with the model 1140)			PD		
Dye Penetrant Certificate			PT		
Radiography Certificate			RT		

*Options may change specifications and dimensions, contact customer service for more information.

**316SS Gate Valves are provided as a standard. If other type of material or valve is required, please consult factory.

Auxiliary Products

One of the greatest advantages of using a magnetic level indicator (MLI) is the extensive list of auxiliary equipment that can be coupled with it to provide an entire level measurement solution. Here are a few that are available to create your complete level solution. Contact your local SOR representative to learn more.

Auxiliary Product	Description	Specifications		
Point Level Switch* 	<ul style="list-style-type: none"> Movable magnetically coupled point level switches offer versatility as well as function. These switches strap to the outside of the Magnetic Level Indicator chamber and sense the magnetic float inside. Explosion proof conduit boxes available on request. 	SPDT	Low Power	Low Power High Temperature
		Power	25 Watts Max	25 Watts Max
		Temperature	-50 to 300°F	-50 to 350°F
		Dead band	1/2" (12.7 mm)	3/4" (19 mm)
		DPDT	Low Power	Low Power High Temperature
		Power	25 Watts Max	25 Watts Max
		Temperature	-50 to 300°F	-50 to 350°F
		Dead band	3/4" (19 mm)	1" (25.4 mm)
815DT Differential Pressure Transmitter* 	<p>The 815DT smart differential pressure transmitter is a feature rich transmitter with the versatility to meet the needs of any application. The stainless-steel construction makes it a rugged, compact instrument ideally suited for hazardous locations and hostile environments. With a variety of industry standard outputs, the 815DT is a low-cost solution to provide continuous output.</p>	<p>Output Signal : HART 7 Communication Protocol with 4-20 mA Output, 1-5 VDC (Low-Power) Mode of Operation Output, Modbus RTU Serial Communications Accuracy: +/- 0.10% Turndown: 5 to 1 Approvals: FM and ATEX in U.S., Canada and Europe <i>Refer to CAT1587 for full specifications</i></p>		
Magnetostrictive Transmitter*	<p>Magnetostrictive transmitters offer an inexpensive option to provide a continuous output to a PLC or DCS. The magnetostrictive transmitter mounts to the outside of the chamber and is activated by the magnetic field of the MLI's float. The SOR float flawlessly operates nearly every magnetostrictive transmitter on the market. SOR will either specify a transmitter for your application or integrate your preferred model.</p>			
Guided Wave Radar*	<p>Guided wave radar is designed to measure liquid level and liquid level interface using microwave pulses. Guided wave radar does not experience errors caused by temperature, pressure or specific gravity changes, making the technology less susceptible to measurement errors. Without any moving parts, guided wave radar is often the preferred technology of design and maintenance engineers all over the world.</p>			

*Options may change specifications and dimensions, contact customer service for more information.

Date _____ Quantity _____

Company Name _____ Contact _____
 Phone _____ E-mail _____
 Special Tag #s _____

Process Conditions

Fluid Upper/Lower _____ Design Pressure _____
 Operating Pressure _____ Specific Gravity Upper/Lower _____
 Design Temperature _____ Operating Temperature _____

Chamber/Indicator Design

Chamber Type (select one)

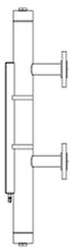
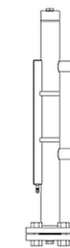
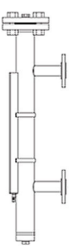
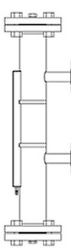
<input type="checkbox"/>	<input type="checkbox"/>	<input type="checkbox"/>	<input type="checkbox"/>
			
Top Sealed Bottom Sealed	Top Sealed Bottom Flanged	Top Flanged Bottom Sealed	Top Flanged Bottom Flanged

Chamber Material _____
 Process Connection Type _____
 Process Connection Size _____
 Vent/Drain Connection Size/Type _____
 Float Material _____

Dimensions (xxx.xxx)

A. Center to Center.....
 B. Measuring Range.....
 C. Offset.....
 D. Ground Clearance....

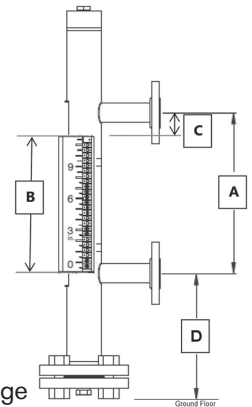

Scale Marking (select one)

English Metric Percentage

Notes (attach any sketches and special instructions)

Accessories (mark as required add notes if necessary)

- Insulation Blanket _____
- Steam Heat Tracing _____
- Electrical Heat Tracing _____
- Radiography Certificate _____
- Mill Test Report _____
- Dye Penetrant Certificate _____
- Hydro Test Certificate _____
- Certificate of Conformance _____
- NACE MR0175 _____
- Flashing/Boiling Protection _____
- Special (specify in notes) _____

Auxiliary Products (mark as required add notes if necessary)

- Point Level Switch (SPDT) _____ Qty. _____
- Point Level Switch (DPDT) _____ Qty. _____
- Magnetostrictive Transmitter _____
- Smart Differential Pressure Transmitter _____
- Guided Wave Radar _____



MEASUREMENT AND CONTROL

SOR Inc. | Lenexa, KS USA | 913-888-2630 | Fax 913-888-0767 | **SORInc.com**

REGIONAL OFFICES

China

SOR China | Beijing, China | china@SORInc.com
+86 (10) 5820 8767 | Fax +86 (10) 58 20 8770

Middle East

SOR Measurement & Control Equipment Trading DMCC | Dubai, UAE
middleeast@SORInc.com | +971 4 363 3637 | Fax + 1 913 312 3596