



# MULTIFUNCTION SPOOL VALVE

air and solenoid air operated  
ISO 5599/01 - Size 1

**5/2-5/3**  
ports / positions

## SPECIFICATIONS

FLUID	: Air or neutral gas, filtered, lubricated or not
PRESSURE	: - 0.950 to +12 bar (can be used with vacuum)
TEMPERATURE	: -10°C, +60°C
FLOW (Qv at 6.3 bar)	: 1400 l/min (ANR)
FLOW COEFFICIENTS	
- conforming to ISO 6358	: C = 5.8 x 10 <sup>-8</sup> m <sup>3</sup> /s.Pa (sonic conductance) b = 0.28 (absolute static pressure)
- conforming to NF E29312	: KV = 20 ( l/min)
LIFE	: 30 millions of cycles (in normal operating conditions)
BASE	: ISO 5599/01 - Size 1
PORTS	: Subbases G 1/4 - G 3/8
SUBBASES	: Single subbases ISO/AFNOR NF E49085 Joinable subbases ISO/VDMA 24345 Joinable subbases with integrated functions Islands MULTIPOL or BUSLINK



## MULTIFUNCTION

Multifunction valves are equipped with 2 pilot selector seals on the top face, on both pilot and return sides. Each selector seal can be set on 2 positions, allowing internal or external supply to the pilot or return operators, in both versions (pneumatic and electropneumatic). External supply allows the valves to operate with a supply pressure ranging from 0 to 12 bar and under vacuum pressure. Each seal includes a tag with an arrow to be set onto the notch corresponding to the required pilot function (see below). Modifications of the function are very simple. The valves are delivered pre-set according to the valve code selected on your order.

**Air operated spool valve**

**Solenoid air operated spool valve**

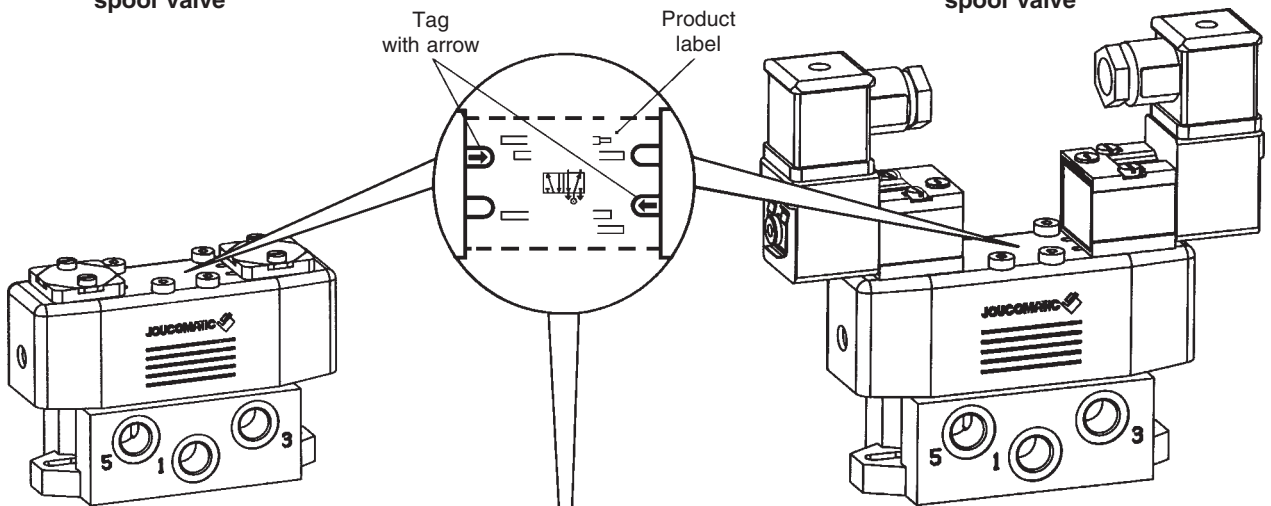

**Pilot operators (side 14)**

**Return operators (side 12)**

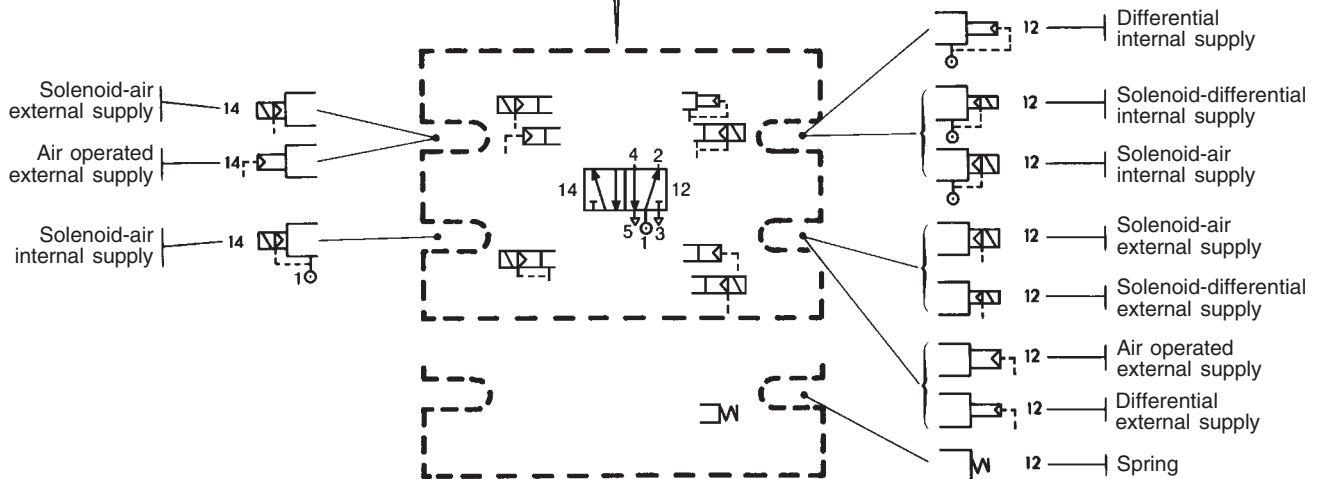

5

# Series 541/PH

The diagram below shows the accessories (delivered with the valves) and/or the solenoid valves appropriate for each function. These components may be separately supplied when changing the function of the valve (the components below are also available for ISO 3 series 543).

	FUNCTIONS		Pilot		Return		
	Symbols	Pilot (14) Return (12)					
5/2		Air operated Spring return		●		●	
		Air operated Differential return		●	●		
		Air operated Air return		●	●		
		Solenoid air operated Spring return	●			●	
		Solenoid air operated Differential return	●		●		
		Solenoid air operated Air return	●		●		
		Solenoid air operated Solenoid differential return	●			●	
		Solenoid air operated pilot and return	●			●	
5/3		Air operated W1-W2-W3		●	●		
		Solenoid air operated W1-W2-W3	●			●	
			Solenoid valves 189-190 or 192	Interface 881 00 074	Interface 881 00 074	Solenoid valves 189-190 or 192	Blanking plate 881 00 073

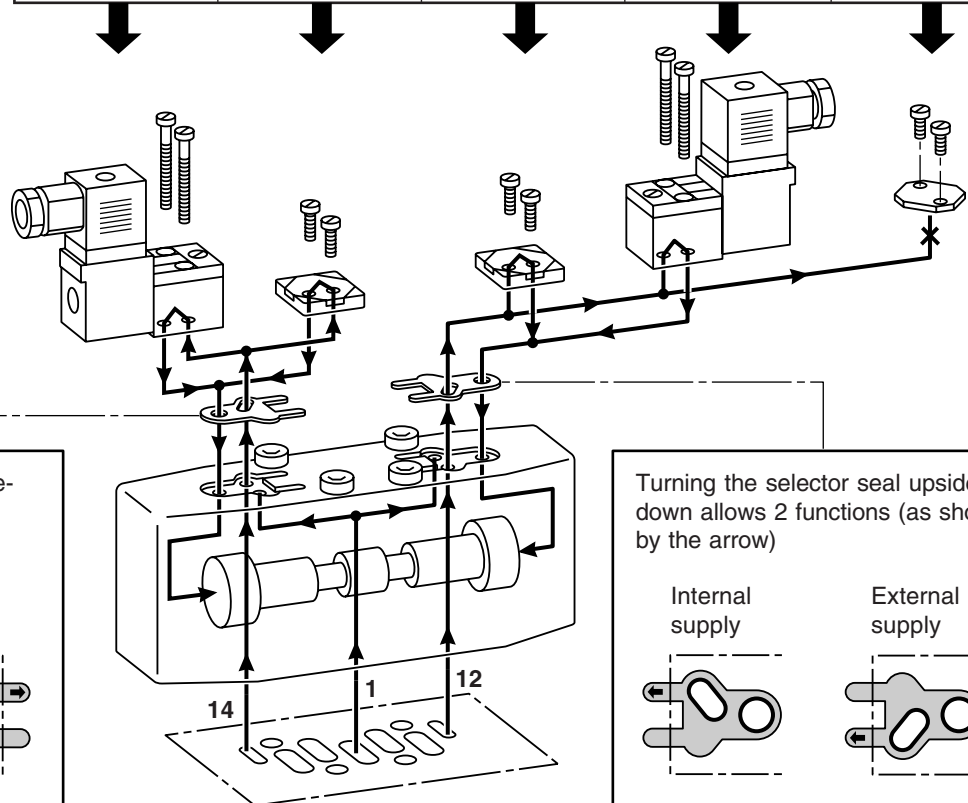

Turning the selector seal upside-down allows 2 functions (as shown by the arrow).

Internal supply

External supply

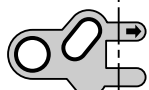
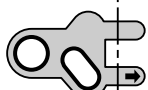

Turning the selector seal upside-down allows 2 functions (as shown by the arrow)

Internal supply

External supply

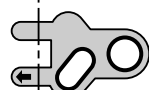
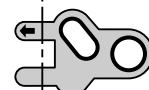

**USE WITH NON LUBRICATED AIR**

The 541/PH - ISO 1 valves will operate satisfactorily with lubricated or non lubricated air, even with dry air due to a patented sealing system : a "T" seal backed with a cushioning or compensation seal.

This arrangement of seals maintains minimum pilot pressure which remains constant even after the valve has been switched off for a long period of time. When restarting, the performance of the valve will be the same as during continuous operating conditions.

This characteristic ensures good performance in both re-start and continuous operation conditions.

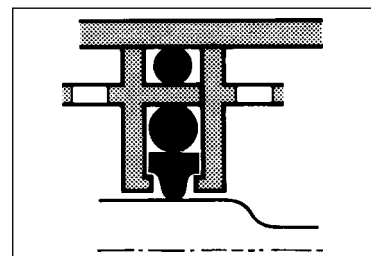
**MANUAL TESTERS INDICATING THE POSITION OF THE SPOOL**

On request, spool valves can be delivered equipped with manual testers so that the spool position can be checked or moved by manual override.

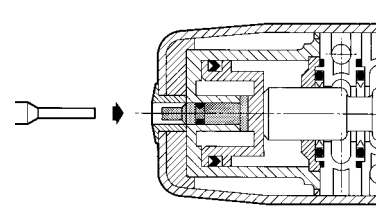
**EASY INSTALLATION**

ASCO/JOUCOMATIC markets a complementary range of components simplifying the installation of valves ISO 1 :

- Single subbase with side ports or bottom ports
- Joinable subbases with bottom ports (1)
- Joinable subbases with integrated functions (2) : this easy-to-assemble equipment offers many advantages :
  - side ports with connectors G 1/4 or instant fittings
  - built-in adjustable flow regulators
  - integrated air supply piping
  - various piping possibilities due to a large number of port connections.
- Islands can be supplied with 4 to 8 monostable or bistable ISO 2 spool valves.
  - Systems designed for electrical connection to a PLC by multi-core cable (MULTIPOL - see P585) or field bus (BUSLINK - see P589) (3)

Numerous accessories complete these systems.



(1)

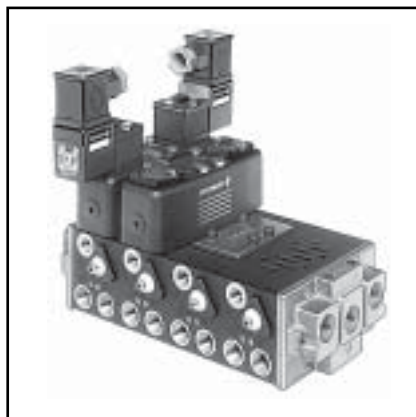

(2)

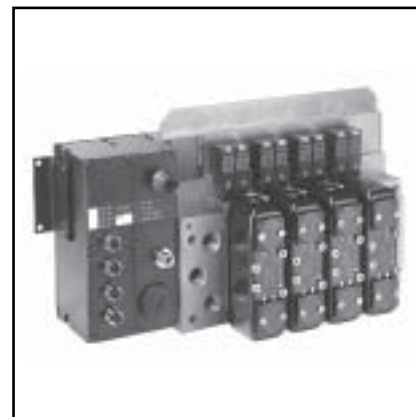

(3)



**SPECIFICATIONS**

FLUID	: Air or neutral gas, filtered, lubricated or not
PRESSURE	: +3 to +10 bar (with internal supply to pilot) +3 to +12 bar (with solenoid valve series 192) - 0.950 to +12 bar (with external supply to pilot) Can be used with vacuum - 0.950 bar max.
PILOT PRESSURE	: See tables choice of equipment
TEMPERATURE	: - 10°C, +60°C
FLOW (Qv at 6.3 bar)	: 1400 l/min (ANR)
FLOW COEFFICIENTS	: C = 5,8 x 10 <sup>-8</sup> m <sup>3</sup> /s.Pa (sonic conductance) b = 0,28 (absolute static pressure)
	: KV = 20 ( l/min)
RESPONSE TIME	: See tables choice of equipment
LIFE	: 30 millions of cycles (in normal operating conditions)
BASE	: ISO 5599/01 - Size 1
PORTS	: Subbases G 1/4 - G 3/8
SUBBASES	: Single subbases ISO/AFNOR NF E49085 Joinable subbases ISO/VDMA 24345 Joinable subbases with integrated functions



**CONSTRUCTION**

Painted steel cover  
 Pilot and return assembly : acetal (POM)  
 Sealing : nitrile (NBR) and polyurethane (PUR)  
 Internal parts : acetal (POM), light alloy  
 Multifunction pilot by selector seal  
 Without or with manual testers checking the spool position

1 = Pressure	12 = Return
2-4 = Outlets	14 = Pilot
3-5 = Exhausts	

**ELECTRICAL CHARACTERISTICS OF PILOTS**

Pilot	Voltages		Consumption		Insulation class	Protection degree	Electrical connection
	~	=	Inrush	Hold			
Series 189	~	24V - 115V - 230V - 50 Hz	6 VA	3,5VA(2,5W)	F	IP 65	Connector rotatable x 180° CM 8 (Pg 9P)
	=	24V	2,5 W				
Series 190	~	24V - 48V - 115V - 230V - 50 Hz	9 VA	4VA(3W)	F	IP 65	Connector ISO 4400 rotatable x 90° - CM 10 (Pg 11P) with simplified connection
	=	12V - 24V - 48V - 110V	3 W				

The solenoid valve 190 is dual-voltage (24V ~, 12V =) (48V ~, 24V =) (115V ~, 48V =) (230V ~, 110V =)

**CHOICE OF EQUIPMENT 5/2**

5/2 Symbols	FUNCTIONS Pilot (14) Return(12)	Response time (ms)		Pilot pressure (in bar)		VALVE		2 CODES + Quantity & code SOLENOID PILOT
		Ener-gized	De-ener-gized	min.	max.	WITHOUT manual tester	WITH manual testers	
	Solenoid air operated - Spring return	30	75	3	10	541 91 023	541 91 006	} + 1x 190 00 022 with connector (LED) 190 60 005 with M12 connection 190 00 018 without connector
	Solenoid air operated - Differential return	40	60	3	10	541 91 024	541 91 007	
	Solenoid air operated - Air return	20	-	1,5	10	541 91 025	541 91 008	
	Solenoid air operated - Solenoid differential return	20	-	3	10	541 91 026	541 91 009	} + 2x 190 00 022 with connector (LED) 190 60 005 with M12 connection 190 00 018 without connector
	Solenoid air operated pilot and return	20	-	1,5	10	541 91 027	541 91 010	

CHOICE OF EQUIPMENT 5/3

5/3	Symbols	Functions	Response time (ms)		Pilot pressure (bar)		VALVE		2 CODES	
			Ener-gized	De-ener-gized	min.	max.	WITHOUT manual testers	WITH manual testers	Quantity & code SOLENOID PILOT	
		Pressure held <b>W1</b> solenoid air operated	30	60	3	10	541 91 028	541 91 011	Manual override: ▼ : impulse	
		Pressure applied <b>W2</b> solenoid air operated	25	60	3	10	541 91 030	541 91 014	+2x	190 00 022 with connector (LED) 190 60 005 with M12 connection 190 00 018 without connector
		Pressure release <b>W3</b> solenoid air operated	30	60	3	10	541 91 029	541 91 012		

(M) Type of manual override on pilot(s) : X : without ● : screwdriver ▼ : impulse

OPTIONS

SOLENOID PILOTS

- Solenoid valve pilot 3/2 series 192 in 3 versions : 1-standard 2-with solenoid head and waterproof metal enclosure (see P592) 3-complying with European standards EEx "d", "m" or "me" for use in explosive atmospheres (see P595)
- Solenoid valve series 189 certified EEx "m" (see P593)
- Solenoid valve intrinsically safe series 630/ia or 195/ia certified EEx "i" (see P590 - P592)
- Solenoid valves series 189 - 190 with double pulse coil (see P514)
- Connector with cable 2m long (see P515)
- Connector with transil protection (see P515-4)
- Solenoid valve with plug and built-in visual control and protection :

Solenoid valve **without** connector + Connector with built-in visual control and VDR/RC protection

Type of valve	(M)	CODE solenoid valve without connector	CODE (~ / =)			
			24V	48V	115V	230V
189 NC	●	189 00 002	881 22 405	881 22 406	881 22 407	881 22 410
190 NC	×	190 00 013	881 22 603	881 22 604	881 22 605	881 22 608
	●	190 00 014				
▼	190 00 018					
192 NC (1)	×	192 00 022				
	●	192 00 023				
	▼	192 00 024				

(M) Type of manual override on pilot (s) : X : without ● : screwdriver ▼ : impulse

(1) Solenoid valve series 192 - 3/2 NC - Ø 2,1mm with exhaust in base

- Monostable or bistable spool valve with a central Ø M12 electrical connector (5 pins)

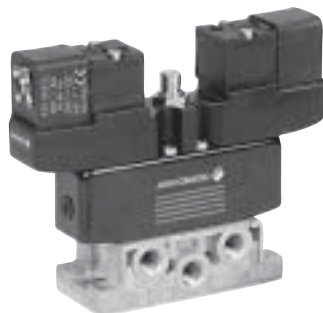

SUBBASES AND ACCESSORIES : see next pages

# SUBBASES ISO 1

DESCRIPTION		PORTS				CODES	
		1	2-4	3-5	12-14		
Type of subbase	Type of port						
Single subbases	Side tapped	G 1/4	G 1/4	G 1/4	G 1/8	<b>355 00 076</b>	
		G 1/4	G 1/4	G 3/8	G 1/8	<b>355 00 061</b>	
		G 3/8	G 3/8	G 3/8	G 1/8	<b>355 00 382</b>	
	Bottom	tapped	G 1/4	G 1/4	G 1/4	G 1/8	<b>355 00 077</b>
		with couplers	couplers for OD Ø 8 mm		G 1/4	couplers Ø 4 mm	<b>355 00 069</b>
Joinable subbases ISO-VDMA	Bottom	subbase	-	G 1/4	-	G 1/8	<b>355 00 165</b>
		set of 2 end plates	G 3/8	-	G 3/8	-	<b>355 00 166</b>
	Set of 3 plugs on main pressure (1) and exhausts (3-5) for 2 different pressure supplies (see (A))					<b>881 35 521</b>	
Joinable subbases with <b>integrated functions</b>	Set of joinable subbases in <b>polyamide</b> , with or without built-in flow regulators and pressure indicators. <b>Side</b> port G 1/4					see page P570-12	
	<b>Metal</b> joinable subbases equipped with plug sets for integrated piping. <b>Side</b> port G 1/4					see page P570-16	
Set of transfer plates and connections to put together different sizes of joinable subbases						see page P570-18	

Set of end plates supplied with 3 plugs G 3/8 (for 1-3-5)

(A) Mounting principle of a plug set : this device allows joinable subbases to be supplied with 2 different pressure inlets.

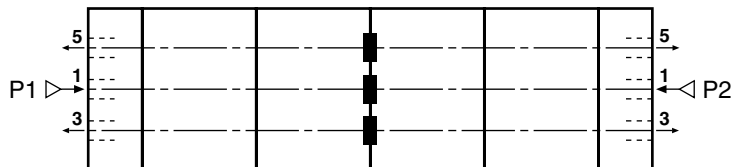

# ACCESSORIES ISO1

## CHOICE OF EQUIPMENT

Designation		Symbol	CODES
<b>Blanking plate to cover interface ISO1</b> This plate allows later assembly with a spool valve.			881 35 517
<b>Flow regulator sandwich</b> This unit, fitted between the subbase and the valve, incorporates 2 flow regulators in the exhaust ports 3 and 5. Flow regulators can be used to control the speed of a double acting cylinder. Weight : 0,230kg			346 00 476
<b>Separate pressure supply module</b> This unit, fitted between the subbase and the valve, allows an individual valve to be supplied with a different pressure from that in the main manifold. The pressure feed within the side bases is not blocked by adding this plate. Pressure supply port P : G 1/4			355 00 118
<b>Sandwich pressure regulator module</b>  This module, which is placed between a subbase and a spool valve, is designed to regulate the pressure and the port according to: - Adjustable pressure: 0.5 to 10 bar - G1/8 (A) port on top for pressure gauge connection - Locking adjustment knob of "Pull-Turn-Push" type   E = 45mm      L = 146mm	<b>on port 1 (supply pressure)</b>  regulator flow at 6 bar: 550 l/min weight: 0,387kg		Button side 12 346 00 474
	<b>on port 2</b>  regulator flow at 6 bar: 850 l/min weight: 0,387kg		346 00 471
	<b>on port 4</b>  regulator flow at 6 bar: 850 l/min weight: 0,387kg		346 00 458
	<b>on ports 2 and 4</b>  regulator flow at 6 bar: 850 l/min weight: 0,577kg		346 00 459
Gauge Ø40 (0 - 12 bar)			343 00 014
G1/8 bracket connection for pressure gauge mounting			881 00 617

5

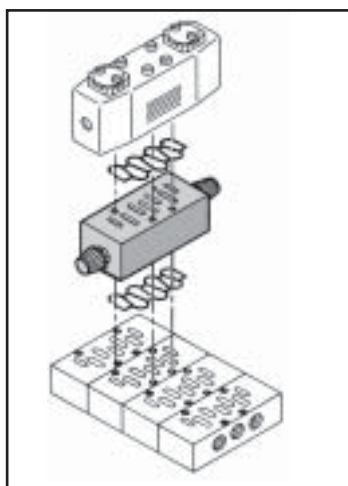

Sandwich flow regulator module

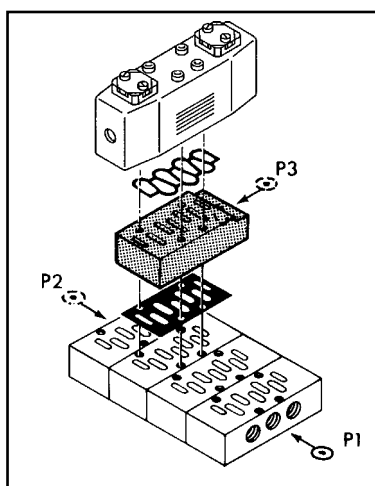

Separate pressure supply module

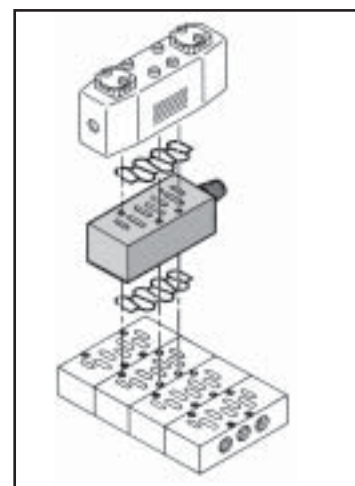

Sandwich pressure regulator module

# Series 541/PH

## DIMENSIONS AND WEIGHTS

### VALVES ON SINGLE SUBBASES

#### Side port

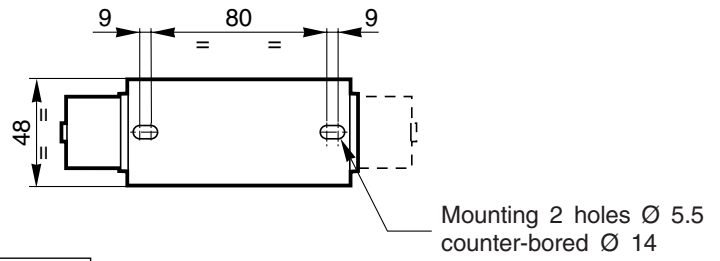

With pilots 189

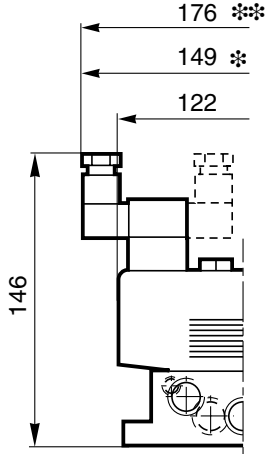

With pilots 190

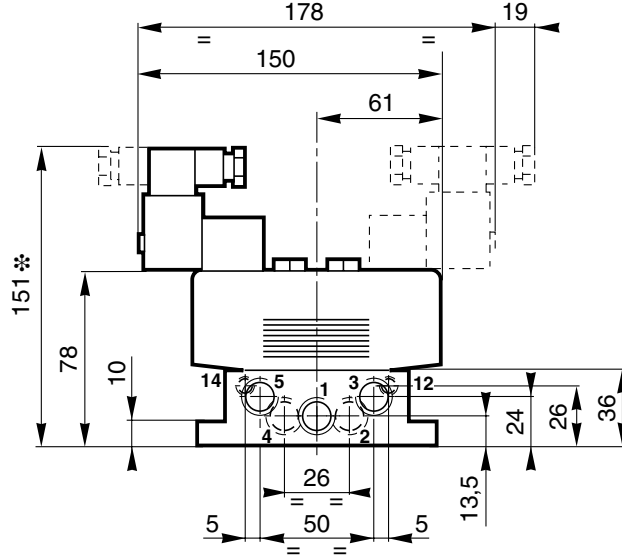

CODES subbases	Port orifices	Port orifices		
		12-14	1-2-4	3-5
355 00 076	Side	G 1/8	G 1/4	G 1/4
355 00 061		G 1/8	G 1/4	G 3/8
355 00 382	Side	G 1/8	G 3/8	G 3/8

Total weight (kg)			
with 1 pilot		with 2 pilots	
189	190	189	190
0,980	1,025	1,080	1,170

#### Bottom port

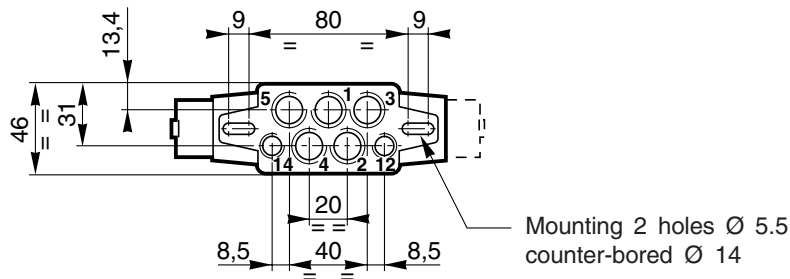

With pilots 189

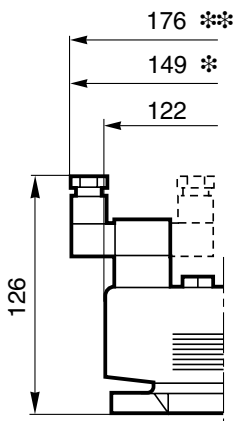

With pilots 190

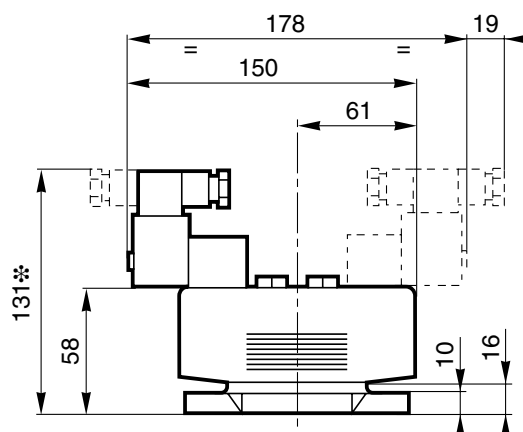

CODES subbases	Port orifices		
	12-14	1-2-4	3-5
355 00 077	G 1/8	G 1/4	G 1/4
355 00 069	Instant fittings Ø4 OD Ø8 OD		G 1/4

Total weight (kg)			
with 1 pilot		with 2 pilots	
189	190	189	190
0,600	0,645	0,700	0,790

- \* + 1 x 15 mm for plug removal
- \*\* + 2 x 15 mm for plug removal

All leaflets available on: [www.ascojoucomatic.com](http://www.ascojoucomatic.com)



**DIMENSIONS AND WEIGHTS**

VALVES ON JOINABLE SUBBASES WITH BOTTOM PORT ISO/VDMA 24345

	CODE	Port orifices		
		12-14	2-4	1-3-5
Subbase	<b>355 00 165</b>	G 1/8	G 1/4	—
2 End plates	<b>355 00 166</b>	—	—	G 3/8

Set of end plates supplied with 3 plugs G 3/8 (for 1-3-5)

Number of subbases	A	B±1	C	Weights (kg)	
				Valves with 2 pilots + subbases + end plates	
				Pilot 189	Pilot 190
3	173	150	86	2,850	3,200
4	216	193	129	3,500	4,000
5	259	236	172	4,100	4,700
6	302	279	215	4,750	5,500
7	345	322	258	5,350	6,200
8	388	365	301	6,000	7,000

Pilot weight : 1 x 189 = 0,120 kg - 1 x 190 = 0,180 kg

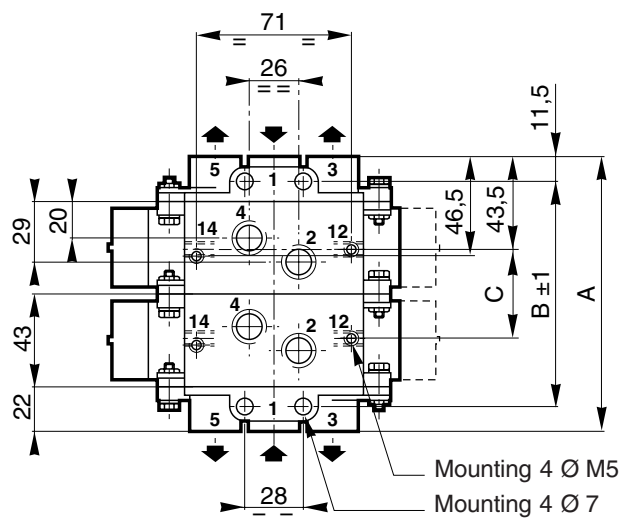

With pilots 189

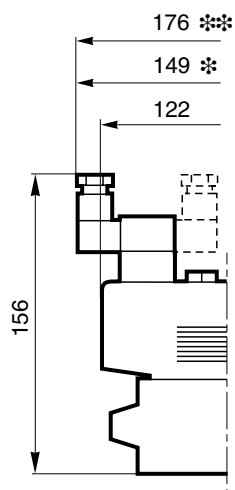

With pilots 190

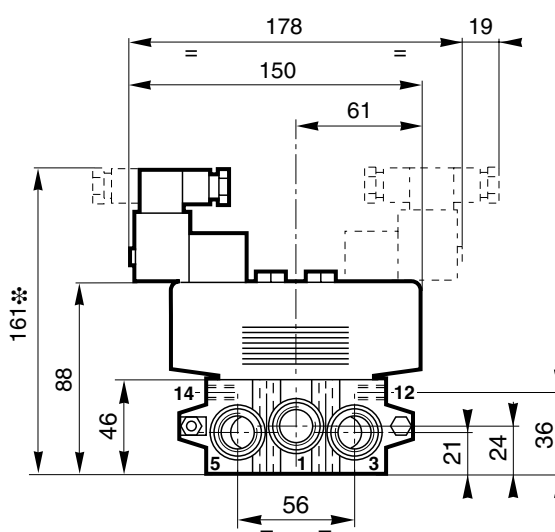

\* + 1 x 15 mm for plug removal  
 \*\* + 2 x 15 mm for plugs removal

# SUBBASE SYSTEM

Metalic joinable subbases with **side ports** G 1/4 with accessories - Series 355  
for valves to **ISO 5599/01 - Size 1**

## GENERAL

This subbase system comprises joinable subbases and accessories with 3 principal characteristics.

- The equipment has a **standard** interface complying with the international standard ISO 5599/1 - Size 1, so that spool valves series 541 can be fitted.
- Subbases for **side ports**.
- The subbases are fitted with selector plates which mean that various piping arrangements and inter-connections can be selected.

## CONNECTION POSSIBILITIES

These joinable subbases with side ports offer many advantages:

- Various piping possibilities due to a large number of port connections.
- Simple assembly in panels due to an improved accessibility to the ports.
- Simple maintenance.
- A reduction in costs due to the removal of pivoting mounting chassis and a reduction in the number of fittings.
- Possibility of mounting directly onto the body of the machine.
- A reduction in lengths of tube giving improved flow rates and improved response times.

These bases allow piping to outlet ports (2, 4) and pilot ports (12, 14) on both side faces, as shown below.

The end plates allow the piping of the supply (1) and exhausts (3,5), in addition, the pilots (12,14) can be piped into the end plates.

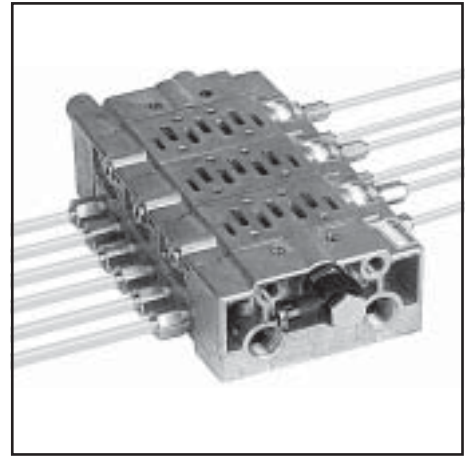

## PIPING THROUGH THE END PLATE

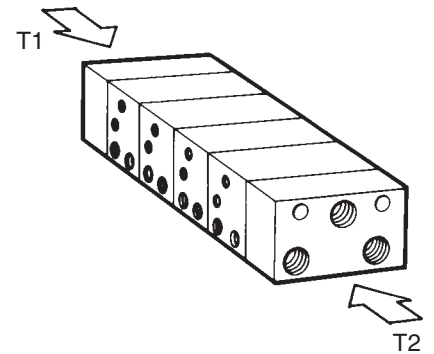

## SAMPLE PIPING ARRANGEMENTS

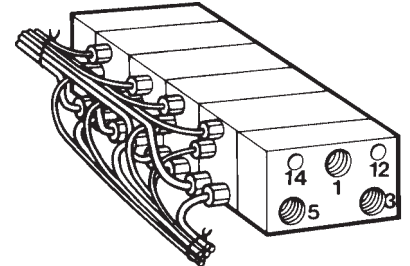
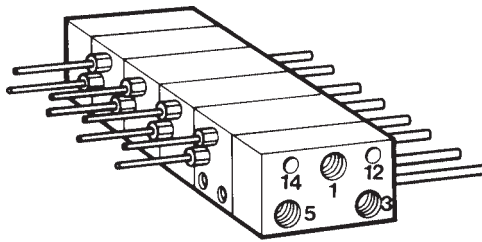
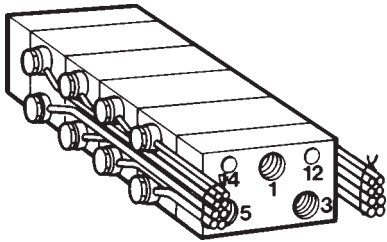

This arrangements allows the use of rotatable fitting

## POSSIBLE FLOW PATHS

The subbases include 5 flow paths (1-3-5-12-14), all of which can be connected through the end plates of each manifold assembly.

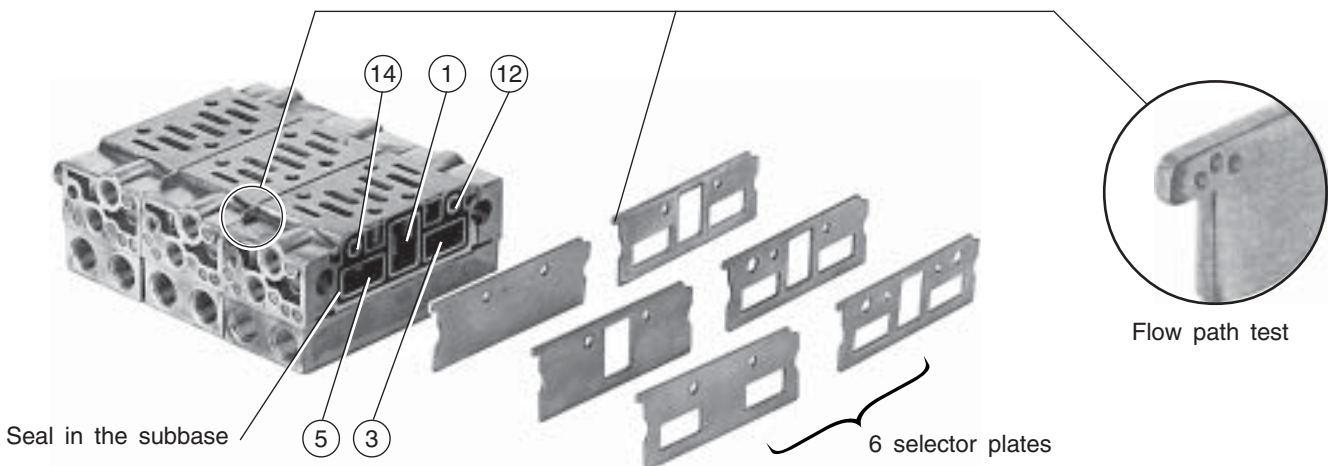

**POSSIBLE FLOW PATHS**

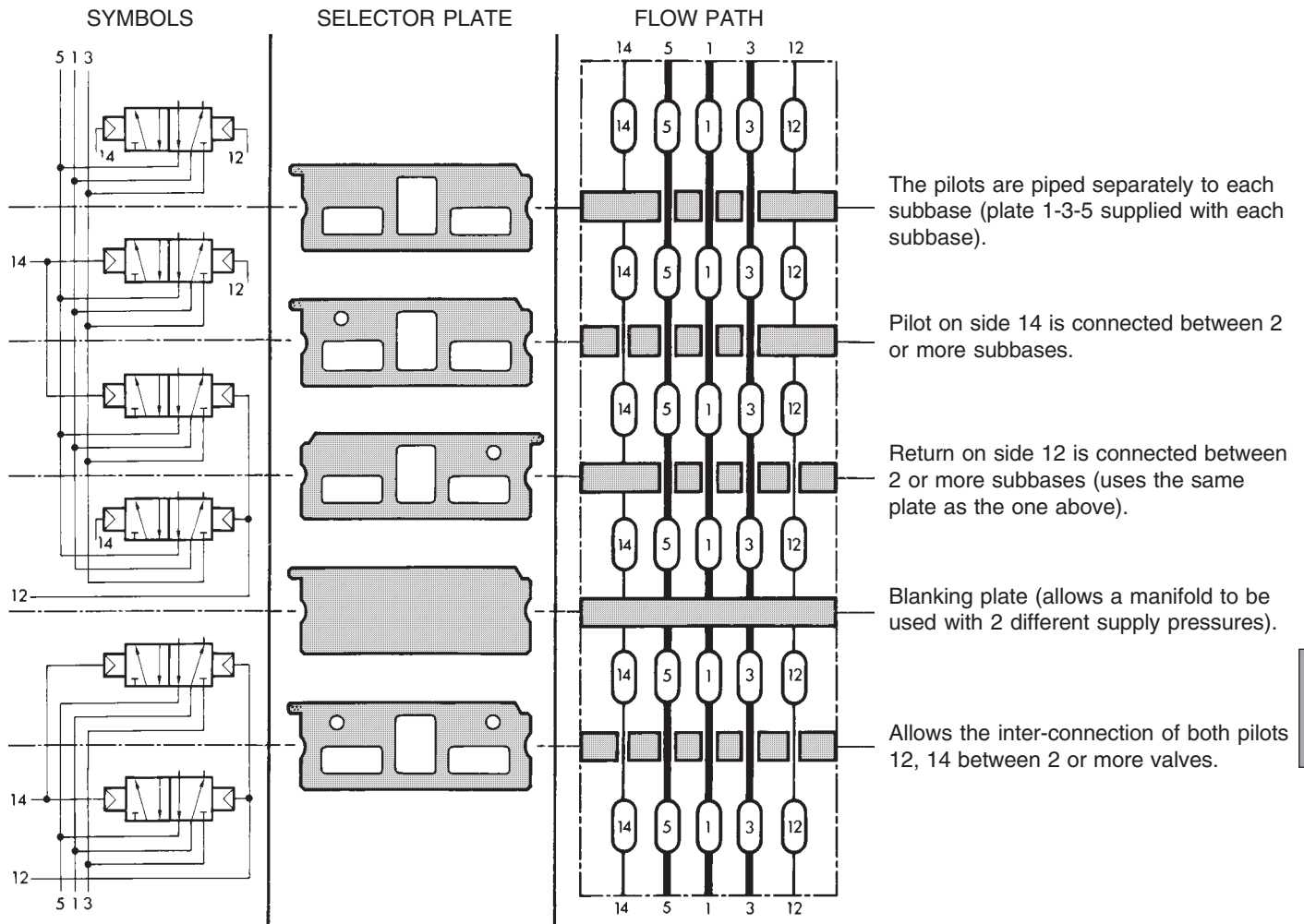

5

**PIPING OF SUPPLY AND EXHAUSTS TO THE END COVERS**

**STANDARD ASSEMBLY**  
Supply and exhausts to 1 side plate.

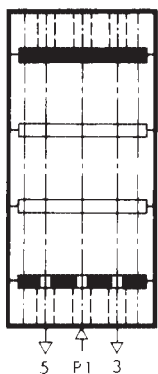

Selector plates supplied as standard allows the assembly as shown above.

Assembly with 2 different pressures and with the exhaust piped to both end plates.

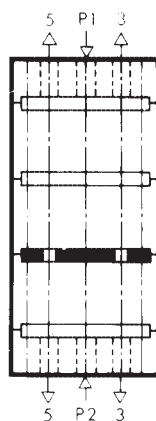

For this assembly a selector plate with connections between 3, 5 is necessary.

Assembly with 1 supply on 1 plate but with exhausts from the 2nd end plate.

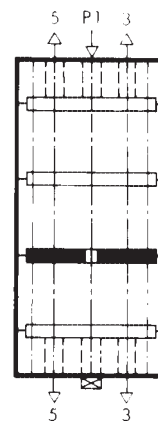

For this assembly a selector plate allows flow through port 1 if required. The supply port in the second plate must be plugged.

Assembly with the supply port in 1 end plate and the exhaust from the other end plate.

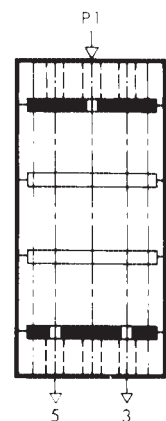

For this assembly you require 2 selector plates, 1 allowing flow through port 1 and 1 allowing flow through ports 3, 5. With ISO 1 bases this arrangement allows the assembly without plugging any ports.

## SUBBASE ISO 1

	Description	Parts list	Ports			CODES
			1-3-5	2-4	12-14	
ISO 1	Joinable subbases with side ports	1 subbase + 2 seals 1 selector plate (connects 1, 3, 5) 2 G 1/4 plugs 1 G 1/8 plug 2 assembly diabolos	—	1/4 BSP	1/8 BSP	355 00 088
	Set of 2 end plates	2 end plates + 2 seals 1 blank selector plate 1 selector plate (connects 1, 3, 5) 2 assembly diabolos	3/8 BSP	—	1/8 BSP	355 00 087
	Blank selector plate (no flow)					881 35 501
	Selector plate (connects port 1)					881 35 512
	Selector plate (connects ports 3, 5)					881 35 510
	Selector plate (connects ports 1, 3, 5)					881 35 502
	Selector plate (connects ports 1, 3, 5 and 1 pilot 12 or 14)					881 35 503
Selector plate (connects ports 1, 3, 5 and 2 pilots 12 and 14)					881 35 504	

## ACCESSORIES ISO 1 (see page P570-9)

### SET OF TRANSFER PLATES AND CONNECTIONS

#### • Set of transfer plates and connections to put together different sizes of ISO - VDMA joinable subbases :

##### ISO 1 - ISO 2 set including :

- A transfer module to allow connection of ISO-VDMA joinable subbases through ISO 1 and ISO 2 **bottom** ports, and connection of supply pressure (1) and exhausts (3-5) through the unit.

- One end plate ISO 1 (ports 1 - 3 - 5)

- One end plate ISO 2 (ports 1 - 3 - 5)

**ISO 1 - ISO 3** set including the same parts as mentioned above, but adapted to the connection of ISO 1 and ISO 3

##### ISO 1 - ISO 2 - ISO 3 set including :

- A transfer module to connect ISO 1 and ISO 2 subbases

- A transfer module to connect ISO 2 and ISO 3 subbases

- One end plate ISO 1 (ports 1 - 3 - 5)

- One end plate ISO 3 (ports 1 - 3 - 5)

#### • Set of transfer plates and connections to put together different sizes ISO joinable metallic subbases :

##### ISO 2 - ISO 1, set including :

- A transfer module to join ISO 1 and ISO 2 subbases.

- One end plate ISO 2 (ports 1 - 3 - 5) : G 3/4

- One end plate ISO 1 (ports 1 - 3 - 5) : G 3/8

### CHOICE OF EQUIPMENT

DESIGNATION	CODES	E (mm)
Set of transfer plate and connections for ISO/VDMA joinable subbases with <b>bottom</b> ports	ISO 1 - ISO 2 355 00 199	20
Set of transfer plate and connections for ISO/VDMA joinable subbases with <b>bottom</b> ports	ISO 1 - ISO 3 355 00 194	32
Set of transfer plate and connections for ISO/VDMA joinable subbases with <b>bottom</b> ports	ISO 1 - ISO 2 - ISO 3 355 00 204	20 + 32
Set of transfer plate and connections for joinable <b>metallic</b> subbases with <b>side port</b>	ISO 1 - ISO 2 355 00 390	30

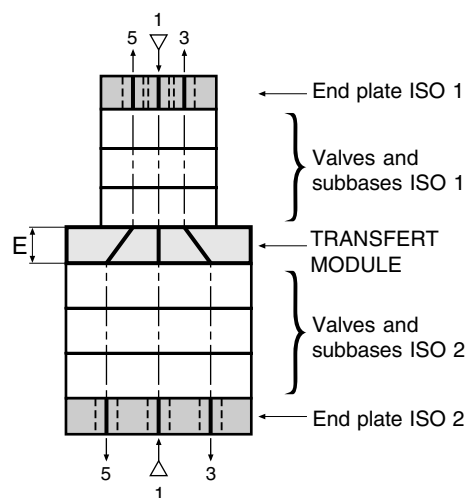

**DIMENSIONS AND WEIGHTS ISO 1**

Ports 1-3-5 : G 3/8  
 Ports 2-4 : G 1/4  
 Ports 12-14 : G 1/8

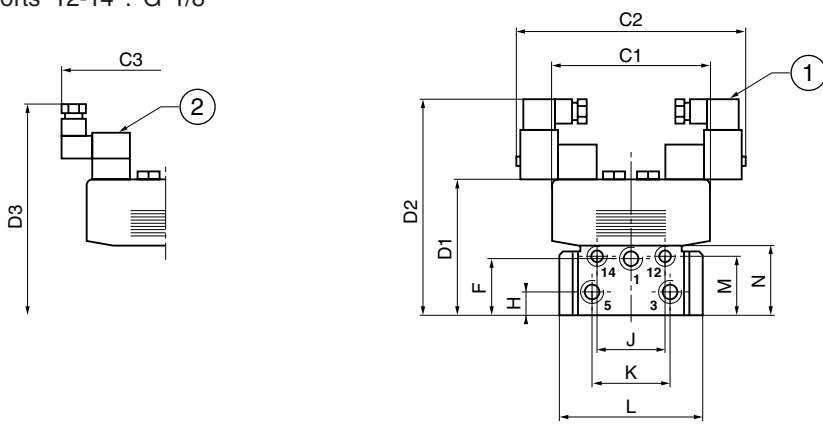

- ① Pilot 190
- ② Pilot 189
- ③ 4 holes  
 $\varnothing$  7 depth 53

Number of subbases	A (mm)	B (mm)	Weight in kg
2	146	106	3,660
3	189	149	4,860
4	232	192	6,060
5	275	235	7,260
6	318	278	8,460
7	361	321	9,660
8	404	364	10,860

Weight = subbases + end plates + valves + 2 pilots 189

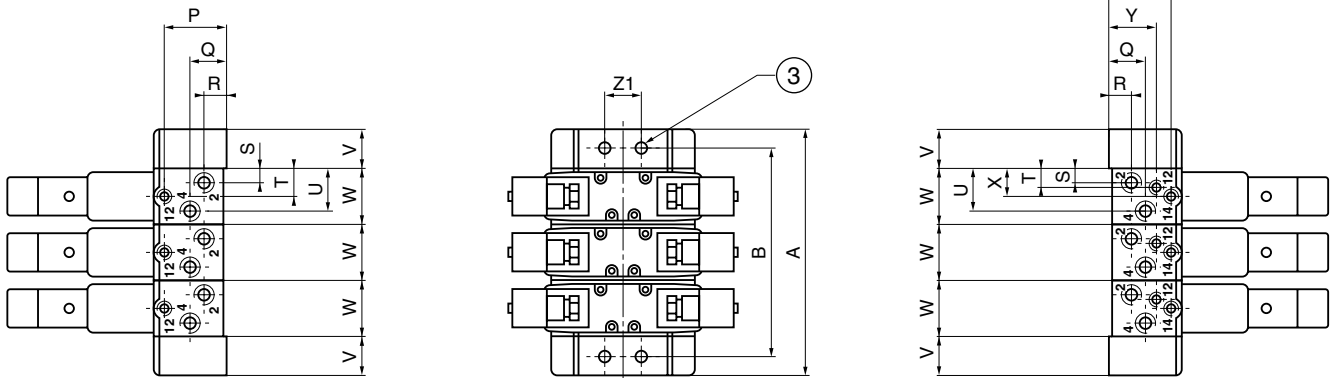

	C1	C2	C3	D1	D2	D3	F	H	J	K	L	M	N	P	Q	R	S	T	U	V	W	X	Y	Z1
<b>ISO 1</b>	122	178	176	95	168	163	42	16	53	59	106	44	53	44	13	13	11	17,5	32	30	43	26	30	28

**ASSEMBLY OF SUBBASES**

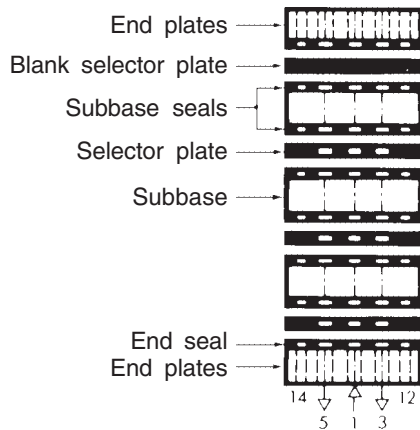

**CONNECTION**

End plates and subbases are connected together using a system of diabolos and grub screws.

