

rotork[®]
Gears

Capabilities & Facilities



Worldwide Manufacturing Facilities
International Service and Support
Innovative Design and Technology
Industry Leading Reliability

Keeping the World Flowing

rotork®

Keeping the World Flowing



RELIABILITY IN FLOW CONTROL CRITICAL APPLICATIONS

› **Reliable operation** when it matters

Assured reliability for critical applications and environments. Whether used 24/7 or infrequently, Rotork products will operate reliably and efficiently when called upon.

› **Customer-focused service** worldwide support

Solving customer challenges and developing new solutions. From initial enquiry through to product installation, long-term after-sales care and Client Support Programmes (CSP).

› **Quality-driven** global manufacturing

Products designed with 60 years of industry and application knowledge.

Research and development across all our facilities ensures cutting edge products are available for every application.

› **Low cost** of ownership

Long-term reliability prolongs service life.

Rotork helps to reduce long term cost of ownership and provides greater efficiency to process and plant.

Capabilities & Facilities

Section	Page	Section	Page
Introduction	4	Quarter-turn Products	9
Engineering Capabilities	5	Quarter-turn and Nuclear Safety Related Products	13
Testing and Quality	6	Multi-turn Products	15
Worldwide Manufacturing and Support Facilities	7	Valve Accessories	18

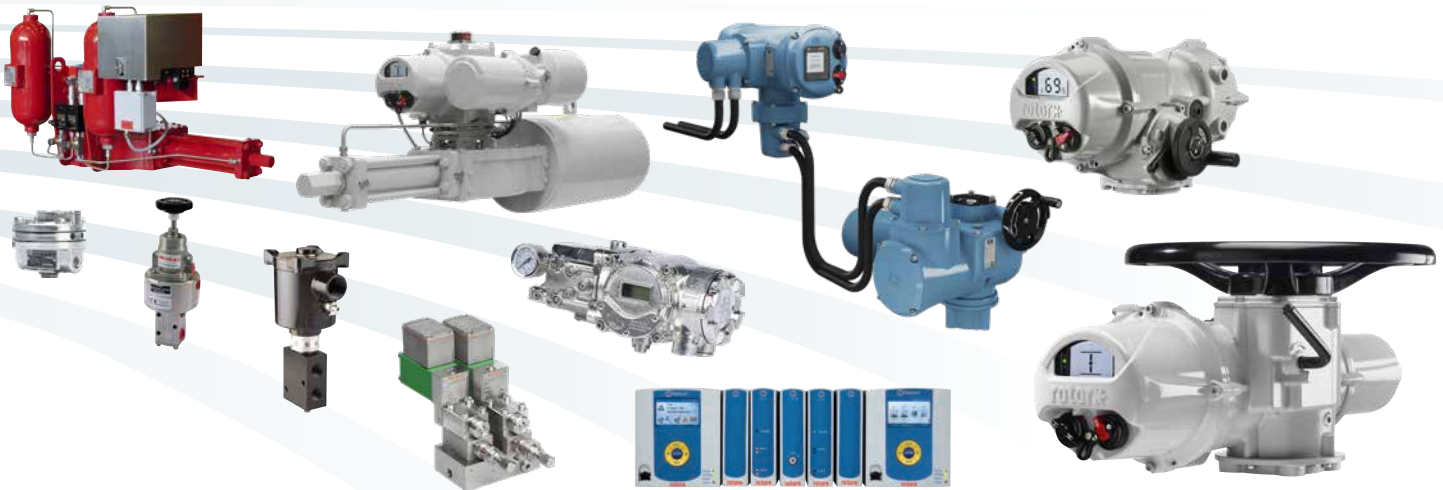

Comprehensive product range serving multiple industries

Improved efficiency, assured safety and environmental protection.

Rotork products and services are used throughout industry inclusive of Power, Oil & Gas, Water & Wastewater, HVAC, Marine, Mining, Pulp & Paper, Food & Beverage, Pharmaceutical and Chemical industries around the world.

Global presence local service

Global company with local support.

Manufacturing sites, service centres, sales offices and *Centres of Excellence* throughout the world provide unrivalled customer services and fast delivery.

Market leader technical innovator

The recognised market leader for 60 years.

Our customers have relied upon Rotork for innovative solutions to safely manage the flow of liquids, gases and powders.

Corporate social responsibility

A responsible business leads to being the best business.

We are socially, ethically, environmentally responsible and committed to embedding CSR across all our processes and ways of working.

Introduction



Rotork is the global market leader in valve automation and flow control. Our products and services are helping organisations around the world to improve efficiency, assure safety and protect the environment.

We strive always for technical excellence, innovation and the highest quality standards in everything we do. As a result, our people and products remain at the forefront of flow control technology.

Uncompromising reliability is a feature of our entire product range, from our flagship electric actuator range through to our pneumatic, hydraulic and electro-hydraulic actuators, as well as instruments, gearboxes and valve accessories.

Rotork is committed to providing first class support to each client throughout the whole life of their plant, from initial site surveys to installation, maintenance, audits and repair. From our network of national and international offices, our engineers work around the clock to maintain our position of trust.

Rotork. Keeping the world flowing.

rotork®
Controls

rotork®
Fluid Systems

rotork®
Gears

rotork®
Instruments



Engineering Capabilities

From the moment you first contact Rotork Gears you benefit from industry leading expertise gained over several decades working at the forefront of valve technology. Our world class engineering team is committed to providing the marketplace with the latest innovative technology achieved using leading-edge design methods.

Concept visualisation and proving:

- In-house 3D rapid prototyping to allow next day creation of 3D concept models: 100 micron accuracy fused deposition modelling 3D printer creates strong ABS (Acrylonitrile butadiene styrene) parts.
- Production trials on rapid prototypes removes uncertainty from the design prior to the design being frozen, allowing greater flexibility of the product early in the development process.



Leading edge design methods:

- Use of parametric and direct 3D modelling and design allows design intent to be accurately captured.
- 3D product manufacturing information from CAD models allows the design to be accurately manufactured, allowing for more complex forms to further optimise part geometry.
- FMEA (Failure Modes and Effects Analysis) and other DFSS (Design for Six Sigma Tools) allow the design to be robust whilst maximising the mapping of customer requirements to the product.



Thorough virtual validation:

- Use of the latest Finite Element Analysis methods for structural, vibration and impact virtual testing of designs prior to prototyping to reduce development time and optimise design integrity.
- Detailed analysis of designs under key operating conditions to reduce mean time between failures.
- Full assembly analysis to accurately recreate operating conditions, specifically related to part interactions incorporating friction and hardware components.

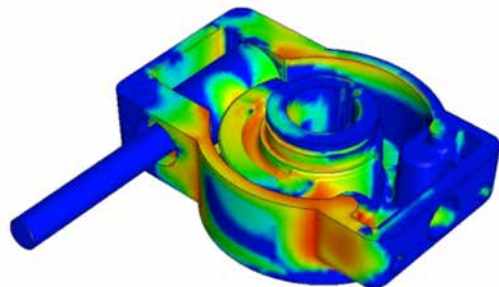

Flexible application Engineering:

- To be able to deliver the standard of service expected by technically demanding customers we have the product knowledge, design expertise and people with a strong commitment to quality to provide dedicated solutions for our customers.

Highly skilled and experienced team:

- A dedicated research and development team to ensure new product design and development, from concept to customer.
- Highly qualified and industry experienced professional engineers in the core design team, plus broad skillset people with specialisms to ensure all aspects of product development are catered for.

Testing and Quality

Test Facilities

Rotork Gears have extensive test facilities at our Leeds location. We have a comprehensive set of test rigs for testing multi-turn and quarter-turn gearboxes across a wide range of torques. We can carry out life testing, overload testing and some environmental testing in-house.

For tests outside our in-house capabilities, such as extremely high torques or salt-spray testing, we can call on the resources of the wider Rotork Group. We also use third party facilities for procedures including nuclear, deep-sea hyperbaric and seismic/vibration testing. The climatic chamber allows us to simulate environments with different temperatures (from -70 to +180 °C) and humidity (from 10% to 98% relative humidity). It is fully self-contained and electronically controlled, and is large enough to allow us to test the majority of our gearboxes in-house. The chamber has intervention panels on both sides which allows us to drive the gearbox from outside the chamber for maximum reliability and flexibility of testing.



Discovery climatic chamber.



Endurance testing of prototype subsea gearbox.

Quality Assurance

Rotork Gears is committed to fully understanding customer needs and expectations, and meeting or exceeding these needs. In support of this Rotork Gears has an established quality management system that meets the requirements of BS EN ISO9001:2015.

The quality management system embraces all aspects of the organisation from new product design and life testing, to specialist application engineering, purchasing, the control of suppliers, verification of purchased materials, assembly and inspection processes.

Rotork Gears is committed to:

- Building business success through customer satisfaction
- The promotion and full understanding of customer needs within the organisation
- Establishing objectives to promote continuous improvement with the ultimate goal of error free performance and to actively encourage employee contribution towards this goal
- Creating a quality culture by making continuous improvement and quality a fundamental part of every employee's performance and responsibility

Quality objectives with measurable outputs are established on an annual basis and reviews held through the year to verify progress against the objectives. The quality manual and policy documents are also reviewed on an annual basis for adequacy and effectiveness. These documents are available to interested parties on request.



Gear teeth dimension check with vernier gear tooth.



Concentricity test with dial indicator.

Worldwide Manufacturing and Support Facilities

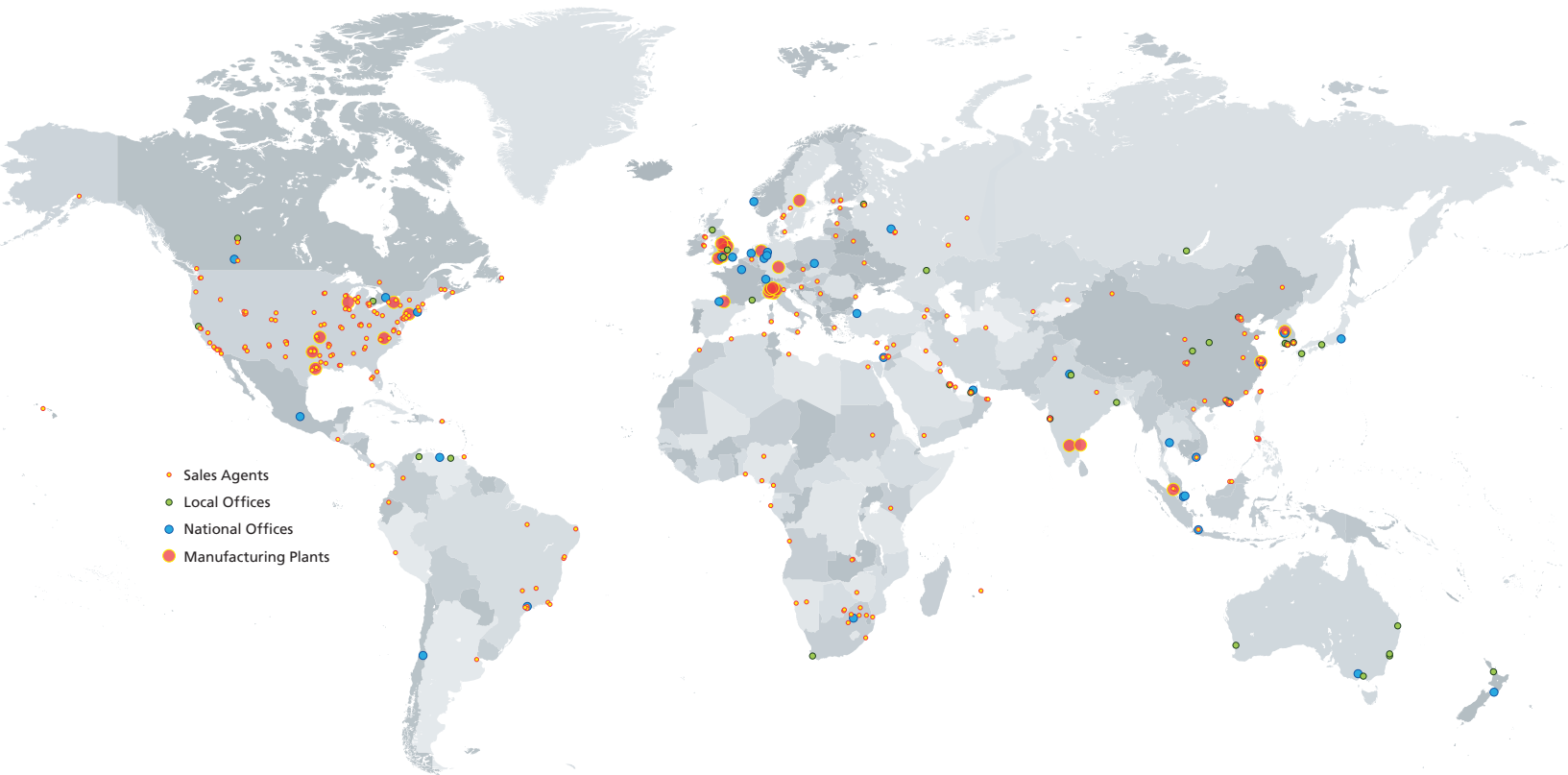

Rotork Gears has manufacturing facilities in the UK, the Netherlands, Italy, the USA, China and India and, as part of the market-leading Rotork Group, are able to offer customers the benefits of responsive, local support through Rotork's extensive international network of offices.

We are the only gearbox manufacturer able to offer a worldwide warranty, service and support to our customers across the globe.

Our worldwide manufacturing and service network enables us to be close to our customers wherever they are. With local sales offices, service engineers and stocking centres located throughout the world, we can simplify your logistical requirements and deliver product with unrivalled support, quickly and efficiently to your site.

Whatever the product, all our customers enjoy the back-up of 225 Rotork offices and representatives located throughout Europe, North and South America, The Far East, Africa, Asia,

Australasia and the Middle East. Our global service network ensures that we are able to respond quickly and efficiently at local and international level – from initial enquiry through to supply, installation, maintenance and upgrades.

The Rotork global sales and service network supports all Rotork Gears products. This network is the biggest global actuation support organisation in the world with direct sales offices and agents in all industrialised countries.

Customer service and field support provides quick and effective response to customer requirements.

Gears



Worldwide Manufacturing and Support Facilities



Leeds, UK.



Shanghai, China.



Losser, The Netherlands.



Houston, USA.



Tulsa, USA.



Jigani, India.



Cusago, Italy.

In addition to these manufacturing centres, Rotork Gears has stocking facilities in South Africa, Australia and Russia.

Quarter-turn Products

232 range



Light-duty worm gear operators

Light-duty cast aluminium quarter-turn gearboxes suited for HVAC, fire protection, and general industrial applications.

Torque range up to 1,500 Nm (1,106 lbf.ft).
7 sizes. Ratios from 37:1 to 45:1.

- Lightweight
- Rugged construction
- Removable output drive sleeves
- IP65
- High pressure aluminium cast housing
- Protected input shaft

242 range



Quarter-turn worm gear operators

Robust and lightweight quarter-turn cast iron gearbox for low torque manual applications. Suitable for ball, plug and butterfly valves.

Torque range up to 2,000 Nm (1,475 lbf.ft).
5 sizes. Ratios 40:1 and 50:1.

- Worm gear
- Manual drive
- Designed using the latest analytical design tools

AB range



Quarter-turn worm gear operators

Heavy-duty cast iron quarter-turn gearboxes suited for ball, plug and butterfly valves serving the water, gas, chemical, power, and demanding industrial applications.

Torque range up to 32,000 Nm (23,600 lbf.ft).
15 sizes. Ratios from 34:1 to 729:1.

- Cast iron
- Axial needle bearings
- Rugged construction for all environments
- IP67
- **Options:** Stainless steel input shaft. Ductile iron. IP68. AWWA. Various environments. Padlockable handwheels. Limit switches. High and low temperatures. Buried service.

QTW150 range



Manual quarter-turn gear operators

Robust, rugged manual gearboxes designed for use in the water and gas pipeline markets.

Torque range up to 150 Nm (111 lbf.ft).
Ratio 40:1.

- Output flange F05 / F07
- Bore Ø 22 mm
- Self-locking gearing
- IP65 minimum sealed unit
- Standard temperature range -20 to +120 °C (-4 to +250 °F)
- Optional padlock

Quarter-turn Products

AB-SS range



Stainless steel gear operators

Heavy-duty stainless steel 316 housing quarter-turn gearboxes suited for plug, ball and butterfly valves serving the water, gas, chemical and power industries in corrosive environments.

Torque range up to 26,000 Nm (19,177 lbf.ft).
11 sizes. Ratios from 34:1 to 729:1.

- Worm gear
- Manual drive
- Stainless steel 316 housing
- Stainless steel 316 input shaft
- Stainless steel 316 fasteners

WG-SS range



Stainless steel gearboxes

Heavy-duty stainless steel 316 housing quarter-turn gearboxes suited for plug, ball and butterfly valves serving the water, gas, chemical and power industries in corrosive environments.

Torque range up to 125,000 Nm (92,195 lbf.ft).
2 sizes. Ratios up to 3,795:1.

- Worm gear
- Manual or electric actuator drive
- Stainless steel 316 housing
- Stainless steel 316 input shaft
- Stainless steel 316 fasteners

BR range



Bronze worm gear operators

The BR series gear operators are manufactured from high quality cast aluminium bronze and stainless steel materials and designed for extended life operation of valves in corrosive man hole and vault steam distribution environments where road salts, standing water and elevated temperatures are common.

Torque range up to 7,000 Nm (5,163 lbf.ft).
3 sizes. Ratios from 34:1 to 217:1.

- Temperature range up to +200 °C (+392 °F)



Quarter-turn Products

IW range

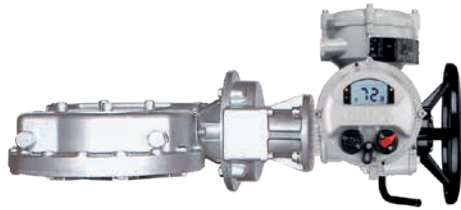

Motorised quarter-turn gearboxes

Complete range of heavy-duty cast and ductile iron quarter-turn worm gearboxes suited for plug, ball and butterfly valves serving the water and waste water, gas, chemical, power, and general industrial applications.

Torque range up to 850,000 Nm (626,890 lbf.ft).
21 sizes. Ratios from 40:1 to 9,600:1.

- Comprehensive gear ratios with a selection of input reducers
- High efficiency
- Angular contact bearings
- Removable output drive sleeves
- IP67
- **Options:** Ductile iron. IP68. AWWA. Nuclear. All types of environment. High and low temperatures. Lever arms. Travelling nut for applications requiring more or less 90 degrees travel. Buried service.

IW High Torque Duty range

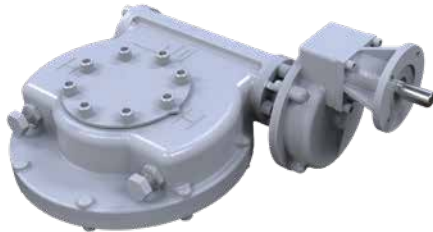

High torque quarter-turn worm gear operators

Designed to suit the infrequent motorised operation of ball, plug and butterfly valves, these gearboxes can offer an increased torque rating.

Torque range up to 203,000 Nm (149,725 lbf.ft).
11 sizes. Ratios from 40:1 to 6720:1.

- IP67
- Comprehensive gear ratios with a selection of input spur gear reducers
- Angular contact bearings
- Removable and repositionable output sleeve
- Repositionable baseplate facility
- Inherently self-locking gear componentry
- **Options:** Flexible extensions. IP68. ATEX. High and low temperatures. All types of environment.

IW range

Heavy-duty cast and ductile iron quarter-turn worm gearboxes suited for plug, ball and butterfly valves serving the water, gas, chemical, power, and general industrial applications.

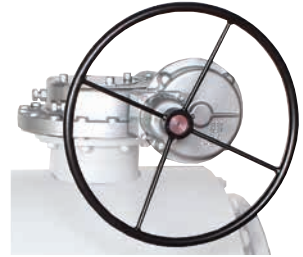

Manual quarter-turn operators

Torque range up to 850,000 Nm (626,890 lbf.ft).
21 sizes. Ratios from 40:1 to 9,600:1.

- Comprehensive gear ratios with a combined selection of input reducers
- High efficiency
- Removable output drive sleeves
- IP67
- Angular contact bearings
- **Options:** Ductile iron. IP68. AWWA. All types of environment. High and low temperatures. Padlockable handwheels. Limit switches. Lever arms. Travelling nut for applications requiring more or less than 90 degrees travel. Buried service.

ABM range



Motorised quarter-turn gearboxes

Quarter-turn devices for the motorised operation of plug, ball and butterfly valves and power and process dampers.

Torque range up to 2,000 Nm (1,475 lbf.ft).
4 sizes. Ratios 34:1 to 200.7:1.

- Supports electric actuator weight up to 46 kg (101 lbs) and a speed up to 96 rpm
- Input: F/FA10
- Ductile iron housing and C45 carbon steel input shaft
- Axial thrust bearings
- Removable insert
- IP67 and ATEX approved
- **Options:** High and low temperatures. Firesafe to ISO 10497. IP68 marinised and buried service.

Quarter-turn Products

ILG-D range



Override quarter-turn gear operators

Complete range of manual declutchable sandwich override quarter-turn gearboxes for double-acting pneumatic actuators.

Torque range up to 17,000 Nm (13,000 lbf.ft).
9 sizes. Ratios from 35:1 to 468:1.

- Protected input shaft
- Cast iron housing
- Axial needle bearings
- IP65
- **Options:** High and low temperature. ISO drive coupling. Solenoid valve to evacuate air automatically. IP67.

ILG-S range

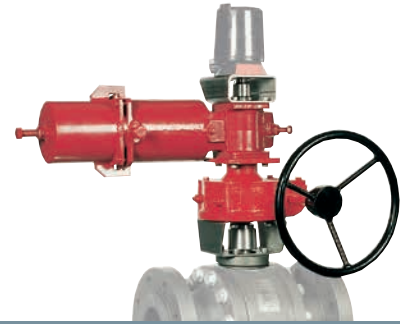

Override quarter-turn gear operators

Complete range of sandwich manual override quarter-turn gearboxes for spring-return pneumatic actuators.

Torque range up to 32,000 Nm (23,600 lbf.ft).
10 sizes. Ratios from 34:1 to 729:1.

- Protected input shaft
- Cast iron housing
- Axial needle bearings
- IP65
- **Options:** High and low temperature. ISO drive coupling.

Mastergear SD range



Override quarter-turn gear operators

Mastergear large manual declutchable gearboxes for use on the largest of pneumatic actuators.

- Torque range from 17,100 to 203,000 Nm (13,000 to 149,725 lbf.ft)
- IP67 or IP68
- Unrivalled versatility through various cover and base flange sizes
- Self-locking, high efficiency
- **Options:** Stainless steel. Fireproof, ATEX and GOST versions. Options for various environments.

WGS range



Subsea quarter-turn gearboxes

The WGS range of quarter-turn gearboxes are designed for heavy-duty subsea applications at any depth with carefully chosen materials to offer the highest level of reliability required in this very harsh environment. The operator is equipped with membrane or piston type pressure compensators to balance the pressure and allow them to work at any depth.

Torque range 2,200 to 500,000 Nm (1,623 to 368,800 lbf.ft).

- Worm shaft supported on taper roller bearings
- High strength alloy steel worm screw hardened and ground
- Vertical or horizontal carbon steel ROV input (class 2 to 7)
- Stroke: 0 to 90° (± 5° adjustable)

Quarter-turn and Nuclear Safety Related Products

ABLX (FM-UL) range



Quarter-turn worm gear operators

Cast iron quarter-turn gearboxes with integrated limit switches for remote position indication suited for fire protection.

Torque range up to 1,620 Nm (1,196 lbf.ft).
4 sizes. Ratios from 34:1 to 40:1.

- Cast iron housing
- Rugged construction
- Removable output drive sleeves
- IP67
- Different types of position indicators
- Suitable for FM/UL/APSAD applications

232LX range



Quarter-turn worm gear operators

Light-duty cast aluminium quarter-turn gearboxes with integrated limit switches for remote position indication suited for fire protection.

Torque range up to 500 Nm (366 lbf.ft).
2 sizes. Ratios 37:1 to 45:1.

- High pressure aluminium cast housing with stainless steel input shaft
- Light weight
- Suitable in corrosive environments
- IP65
- Removable output drive sleeves
- Powder coated
- Different types of position indicators

FB range

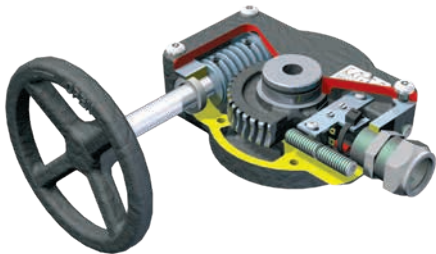

Worm gear operators

Quarter-turn cast iron gearbox suitable for use with fire protection (i.e. sprinkler) systems, includes limit switches to be incorporated into a supervisory electrical circuit. Designed and tested specifically to meet UL1091 specification and FM1112 approval.

Torque range up to 1,000 Nm (737 lbf.ft).
5 sizes. Ratios from 40:1 to 60:1.

- Worm gear
- Manual drive
- 3 x overload capacity
- 1,000 cycles

IWN, IBN ISN, 242P ranges

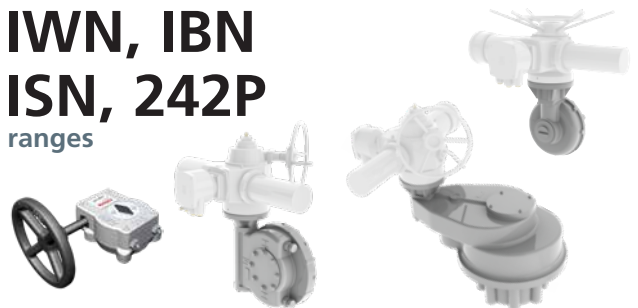

Nuclear safety related gearboxes

Rotork's IBN, ISN, IWN, & 242P ranges of gearboxes for the nuclear power industry are designed and tested to meet the latest plant specifications and industry standards such as IEEE, RCC-E and IEC.

Rotork is an internationally audited and approved nuclear actuator manufacturer, and all actuators are manufactured in accordance with strict nuclear industry quality assurance requirements.

- Manual and motorised options (242P manual only)
- Quarter-turn and multi-turn outputs
- Can be used inside or outside containment (242P outside only)
- Nuclear grade materials and grease
- Various ratios to meet each applications requirements

Quarter-turn Products

AB-AWWA (C504 and C517) range



Quarter-turn worm gear operators

Worm gear operators suitable for the manual actuation of AWWA C504 butterfly valves and C517 plug valves.

Torque range up to 2,000 Nm (1475 lbf.ft).

Ratios from 34:1 to 48:1.

- 90% grease filled for life and fully sealed
- Self-lubricating sleeve bearings
- Standard temperature range -20 to +120 °C (-4 to +250 °F)
- Above or buried service
- 300 lbf.ft overload capability
- **Options:** Stem extensions. Square nut. Padlock kit. NAMUR and Westlock position indicator mounting kit. High and low temperatures. Open right service. 450 lbf.ft overload capability (unavailable for AB550AW).

IW-AWWA (C504 and C517) range



Quarter-turn worm gear operators

Worm gear operators suitable for the manual actuation of AWWA C504 butterfly and C517 plug valves.

Torque range up to 164,000 Nm (120,960 lbf.ft).

Ratios from 48:1 to 2374:1.

- 90% grease filled for life and fully sealed
- Self-lubricated drive sleeve
- Standard temperature range -40 to +120 °C (-40 to +250 °F)
- Maximum stem acceptance diameter - 12" bored with ANSI B17.1 square key
- Above or buried service
- IP68
- **Options:** Stem extensions. Padlock kit. NAMUR & Westlock position indicator mounting kit. High and low temperatures. 2" square nut. 450 lbf.ft service. Mitre box - IB2 for FA10 mounting or IB4 for FA14 mounting.

MOW range



Worm gearboxes

Heavy-duty quarter-turn modulating gearboxes suited for control valves.

Torque range up to 47,000 Nm (34,500 lbf.ft).

9 sizes. Ratios from 40:1 to 3,000:1.

- Up to 1,200 starts per hour
- Ground and polished worm shaft
- Aluminium bronze worm wheel
- Comprehensive gear ratios combined with a selection of spur input reducers
- Angular contact bearings
- Removable output drive sleeves
- **Options:** All types of environment.

Lever Arm range



Lever arms for damper operation

Used on dampers to transfer the 90° operation from the worm gearbox to the damper spindle.

- **Option for IW range:** This is an optional feature on all our IW and MTW ranges of worm gearboxes.

Multi-turn Products

IB

range



Motorised multi-turn gearboxes

Complete range of heavy-duty cast iron multi-turn bevel gearboxes suitable for the most demanding motorised applications for cast and fabricated sluice gates, gate valves and globe and pinch valves.

Torque range up to 8,135 Nm (6,000 lbf.ft).
Thrust range up to 1,320 kN (296,750 lbf).
13 sizes. Ratios from 1:1 to 120:1.

- **Common options for IB:** Spring-loaded temperature compensators. Various position indicators. AWWA. High and low temperature. All types of environment. IP68. Cast steel.

HOB/MPR

range



Bevel gear operators

Hand operated bevel gears suited for sluice gates, gate, and globe valves.

Torque range up to 8,018 Nm (5,914 lbf.ft).
Thrust range up to 1,557 kN (350,028 lbf).
12 sizes. Ratios from 2:1 to 81:1.

- Cast iron body
- Maintenance free
- IP67
- **Options:** All types of environment. Position indicators. IP68.

IS

range



Motorised multi-turn gearboxes

Complete range of heavy-duty cast iron multi-turn spur gearboxes suitable for the most demanding motorised applications where the gearbox input shaft needs to be parallel with the valve stem for globe and gate valves and sluice gates.

Torque range up to 43,386 Nm (32,000 lbf.ft).
Thrust range up to 2,900 kN (652,000 lbf).
19 sizes. Ratios from 1:1 to 360:1.

- **Common options for IS:** Spring-loaded temperature compensators. Various position indicators. AWWA. High and low temperature. All types of environment. IP68. Cast steel.

HOS/MPR

range



Spur gear operators

Multi-turn devices intended for the manual operation of gate, globe, sluice and penstock valves. For use above and underground with upward or downward input orientation.

Torque range up to 15,917 Nm (11,740 lbf.ft).
Thrust range up to 1,557 kN (350,000 lbf).
13 sizes. Ratios from 2.04:1 to 151.9:1.

- Totally enclosed gearing
- Cast iron gearcase
- IP67

Multi-turn Products

MTW range



Worm gearboxes

The multi-turn worm gearboxes are used for applications such as sluice gates and dampers.

Torque range up to 162,000 Nm (119,000 lbf.ft).
11 sizes. Ratios from 40:1 to 5,760:1.

- Ground and polished worm shaft
- Aluminium bronze worm wheel
- Comprehensive gear ratios combined with a selection of spur input reducers
- Angular contact bearings supporting worm shaft
- Removable output drive sleeves
- **Options:** Travelling nut for applications requiring mechanical stops. Lever arms. AWWA. All types of environment.

DSIR range

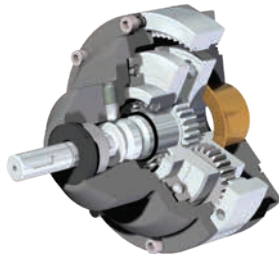

Dual speed gear operators

The Dual Speed Input Reducer is used to reduce the number of input turns required, and therefore the operating time, on manual gearbox applications. It can be used with any manual gearbox which can be fitted with an F14 or FA14 input flange.

Output torque 720 Nm (6,373 lbf.in).
Ratio can be switched between 1:1 and 4.25:1.

SPI range



Smart Position Indicator (SPI)

Limit switches enclosed in an IECEx/ATEX certified protective enclosure, providing an accurate and reliable Open/Close signal to the control room for multi-turn manual valves.

4 sizes. Ratios from 34.8:1 to 1196:1.

- Manual duty
- ISO5210 F10 output
- Aluminium housings
- IP67
- Mount to existing F10 input flange, direct mount to rising stem valve
- **Options:** Pin / key handwheel.

DSB range

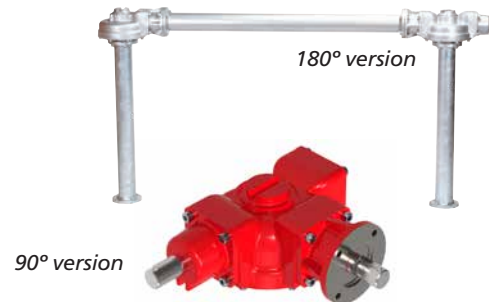

Dual shaft bevel gear operators

Complete range of multi-turn bevel gearboxes with two shafts for use with dual stem sluice gates and penstocks.

Torque range up to 8,135 Nm (6,000 lbf.ft).
Thrust range up to 1,320 kN (296,750 lbf).
13 sizes. Ratios from 1:1 to 120:1.

- Ductile iron baseplates
- Comprehensive gear ratios combined with a selection of spur input reducers
- Pinions mounted on ball bearings
- IP67
- **Options:** All types of environment. Various position indications. IP68. Input shafts available at 90° & 180° to each other.

Multi-turn Products

NTB range



Bevel gear operators

Cost effectively designed bevel gearboxes suitable for valves which do not transfer thrust to the operator.

Torque range up to 70,000 Nm (51,590 lbf.ft).
12 sizes.

Various ratios to suit the application.

- Cast iron body
- Maintenance free
- IP67
- **Options:** All types of environment. Various position indicators. IP68.

Mastergear Large Bevel Gear range



Large bevel gear operators

Complete range of ductile iron multi-turn bevel gearboxes suitable for the most demanding manual and motorised applications. Suitable for cast and fabricated sluice gates, gate valves, globe and pinch valves.

Torque range from 30,000 to 70,000 Nm (22,127 to 51,590 lbf.ft)
Thrust range from 3,000 to 6,500 kN (674,427 to 1,461,200 lbf)
Ratios from 6:1 to 480:1.

- Thrust / non-thrust taking versions
- IP67
- **Options:** Spring-loaded temperature compensators. Various position indicators. High and low temperature. All types of environment. IP68. Cast steel.

Mastergear SS Bevel range



Stainless steel bevel gear operators

Heavy-duty stainless steel 316 housing multi-turn gearboxes suitable for the most demanding manual and motorised applications. Suitable for cast and fabricated sluice gates, gate valves, globe and pinch valves.

Torque range up to 2,300 Nm (1,696 lbf.ft).
Thrust range up to 330 kN (74,200 lbf).
3 Sizes. Ratios from 4.5:1 to 20.25:1.

- Stainless steel 316 input shaft
- Thrust / non-thrust taking versions
- IP67 / IP68
- **Options:** Spring-loaded temperature compensators. Various position indicators. High and low temperature. All types of environment.

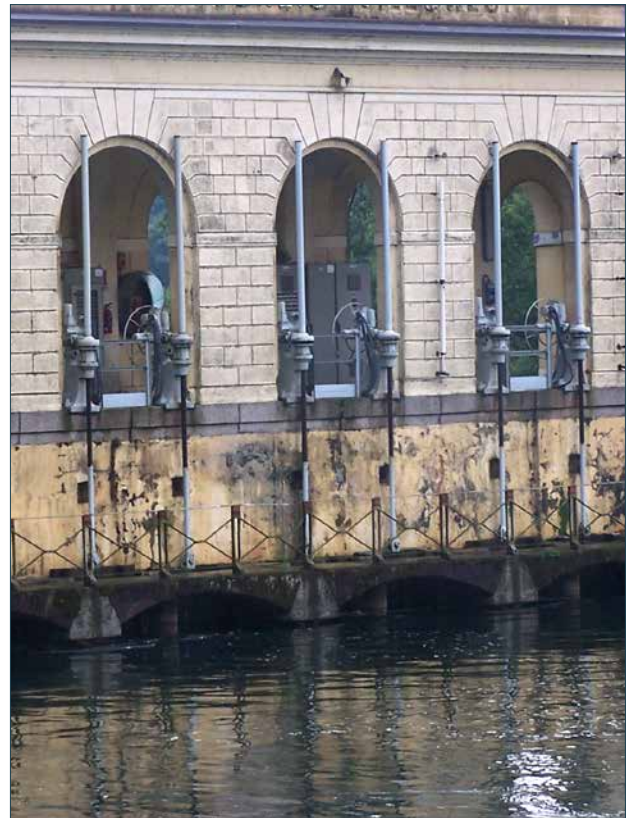

Mounting kits

ball, butterfly and plug valve kits



Ball, butterfly and plug valve kits designed to order, precision CNC machined in stainless steel

A complete range of precision CNC machined stainless steel or carbon steel mounting kits. With open or closed construction, mounting kits are engineered from certified material, individually bagged and labelled ready for assembly.

Quarter-turn valve adaption for rack and pinion or pneumatic actuators can be provided in the form of spool or pedestal type mounting kits. These are fully enclosed carbon steel adaptors with options DD, square or keyed drives.

- To suit valves from 1/4" to 48"
- F03 - F35 flanges - ISO 5211/DIN 3337
- **Options:** O-ring seals, stress calculations, material certification, alternative materials, custom design, logo or brand names.

Handwheels

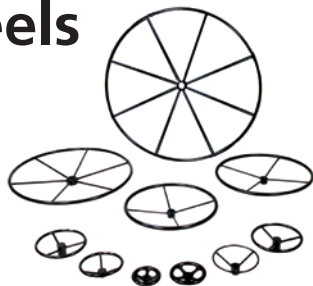

Stainless steel and powder coated handles

- 125 to 2,000 mm diameter
- Stainless steel or powder coated
- Keyed, pinned or square drive
- Fabricated or pressed design
- Oval or round designs for small valves
- Open and closed indication marking
- **Options:** Locking flange, handle, specials, galvanised, rotating handle, flat or dished.

SOLDO

range



Switch box and position indication

The Soldo range of switch boxes for use on quarter-turn valves and actuators. They are available in durable polycarbonate, 316 stainless steel and aluminium, and can be used on actuators, valves, or in conjunction with a hand wheel or lever.

- IP66, IP67, IP68, Safe area operation
- Hazardous approval, Exd IIC, Ex ia IIC +H2 -ATEX
- Beacon/Local indicator available
- 4 to 20 mA
- V3 micro switches or Inductive sensors
- Open/Closed feedback sensors for multi-turn valves are also available

Alcatraz Interlocks

range

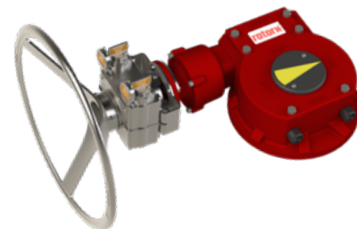

Interlocking Systems

Interlocking systems for safe operation. Used to prevent potentially hazardous situations caused by errors in the operating sequence of industrial processes. The operator is forced to follow a predetermined sequence by means of a mechanical coded key transfer.

- Bespoke interlock systems designed to suit individual needs
- Easy to install and operate, maintenance free
- Stainless steel 316
- Fire tested according to API 607
- Test certificate EN 10204 3.1 available on request
- Resistant to dirt, sand and moisture ingress
- Non-intrusive, placed between existing handwheel and gearbox

Valve Accessories

Remote mounting and extension spindles

Valve and actuator remote mounting and extension spindles.

Remote actuator mounting can be achieved using valve extension spindles or pedestal adaptors. Lengths can be from 500 mm to 8 m, in stainless steel or carbon steel.

Extension spindle

- Underground applications
- Customer specified extension
- Welded construction for weight saving
- Position indication option
- Suitable for manual or actuated drives
- **Options:** Oil filled, environmental sealing, galvanised, plain or dynamic bearings, swivel joints.

Remote position indicator

Mechanical remote ECL position indicators for buried service and shaft extension applications. The ECL is available in two versions, one with an F10 base plate to fit any extension with F10, and an ECL BB which has an F14 base plate to fit any extension with F14.

W100 1:1 bevel gearbox

1:1 bevel gearbox designed primarily to be used on AB and manual duty IW quarter series gearboxes to change the input shaft direction by 90° for underground applications.

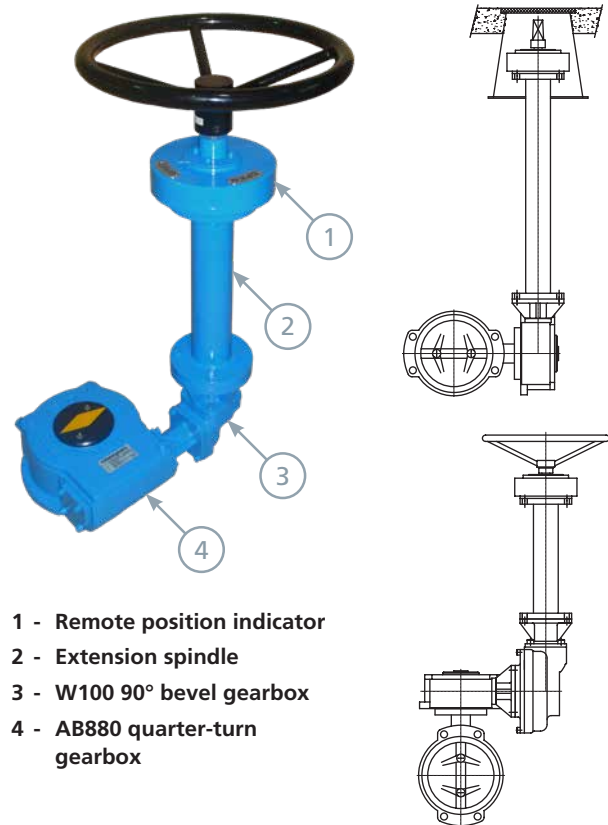

- 1 - Remote position indicator
- 2 - Extension spindle
- 3 - W100 90° bevel gearbox
- 4 - AB880 quarter-turn gearbox

Rotohammer Chainwheels

range



Chainwheels and valve extensions

Rotohammer offers the very best solutions for hard-to-reach and difficult to operate valves, with the purpose of protecting people and equipment with safe, dependable valve operation.

Rotohammer manufacture clamp-on sprockets chainwheels to fit handwheels size from 4" to 40". They are made with different materials (ductile, aluminium and stainless steel) and protections to cater for very harsh environments.

Rotohammer also make a variety of innovative custom solutions.

Chainwheels

range



Direct mount chainwheels

Chainwheels mount directly onto the gearbox input shaft by a pin or coupling. Suitable for use with every Rotork gearbox.

- Cast iron chainwheels 135 to 330 mm (5.32 to 13") diameter
- Chain guides and bearing are standard
- Chain and chainwheel sprockets are to DIN 766
- Galvanized or stainless steel chain available
- Epoxy coating for durability available
- **Options:** AISI316 chainwheel and chain, sheradisation protection, adaption design to suit application.



Keeping the World Flowing

Rotork Gears UK
9 Brown Lane West
Holbeck, Leeds LS12 6BH
England
tel +44 (0)113 256 7922
email sales@rotorkgears.com

Rotork Gears BV
Nijverheidstraat 25
7581 PV Losser
P.O. Box 98, 7580 AB Losser
The Netherlands
tel +31 (0)53 - 5388677
fax +31 (0)53 - 5383939
email info@rotorkgears.nl

Rotork Gears India
165/166, Bommasandra
Jigani Link Road
Kiadb Industrial Area
Anekal Thaluk
Jigani Hobli, Bangalore 562106
India
tel +91 80 3098 1600
fax +91 80 3098 1610
email sales@rotork.co.in

Rotork Gears Americas
1811 Brittmoore
Houston, Texas 77043
USA
tel +1 713 9837381
fax +1 713 8568022
email gears@rotorkgears.com

Roto Hammer Industries
Rotork Tulsa, Inc.
4433 West 49th Street, Suite D
Tulsa, OK 74107
USA
tel +1 (918) 446-3500
fax +1 (918) 446-6218
email sales@rotohammer.com

Rotork Gears Shanghai
No. 260 Lian Cao Road
Xin Mei Urban Industrial Park
Min Hang District
Shang Hai 201108
China
tel 0086 21 33236200
fax 0086 21 64348388
email info@rotorkgears.com.cn

Rotork Gears S.R.L.
Viale Europa 17
20090 Cusago (MI)
Italy
tel +39 0290 16711
fax +39 0290 390368
email rgsrl.sales@rotork.com

www.rotork.com

A full listing of our worldwide sales and service network is available on our website.

Rotork plc
Brassmill Lane, Bath, UK
tel +44 (0)1225 733200
fax +44 (0)1225 333467
email mail@rotork.com

Rotork is a corporate member of the Institute of Asset Management



PUB027-001-00
Issue 08/18

As part of a process of on-going product development, Rotork reserves the right to amend and change specifications without prior notice. Published data may be subject to change. For the very latest version release, visit our website at www.rotork.com.

The name Rotork is a registered trademark. Rotork recognizes all registered trademarks. Published and produced in the UK by Rotork Controls Limited. POWJB0818