

## G-Series Embedded Redundant Model GTE Analog (Voltage/Current)

### Data Sheet

Document Part Number  
551386 Revision C (EN) 05/2016



Model GTE embedded redundant position sensor

#### FEATURES

- Offers Redundancy for Enhanced Safety Applications
- Linear, Absolute Measurement
- Contains Two Independent Measuring Systems in a Single Compact Housing
- Non-Contact Sensing Technology
- Superior Accuracy, Linearity Deviation Less Than 0.02%
- Repeatability Within 0.001%
- Fully Adjustable Analog Outputs (Voltage or Current) Within: -10 to +10 Vdc or 0 to 20 mA
- Available with IECEx certification for hazardous areas

#### BENEFITS

- Rugged Industrial Sensor
- Compact Design with a 10 mm (0.39 in.) O.D. Stainless-Steel Rod
- Embeddable for added protection in harsh environments

#### APPLICATIONS

- Ideal for High-Safety Applications Requiring Redundancy
- Continuous Operation In Harsh Industrial Conditions
- High Pressure Conditions

#### TYPICAL INDUSTRIES

- Power Plants
- Water and Wind Turbine Pitch Settings
- Marine Propellers
- Ship Control Systems
- Floodgate Control

#### Time-based Magnetostrictive position sensing principle

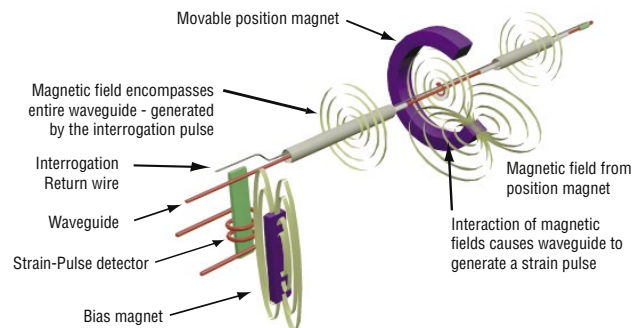

#### Benefits of Magnetostriction

Temposonics® linear-position sensors use the time-based magnetostrictive position sensing principle developed by MTS Sensors. Within the sensing element, a sonic-strain pulse is induced in a specially designed magnetostrictive waveguide by the momentary interaction of two magnetic fields. One field comes from a movable permanent magnet that passes along the outside of the sensor. The other field comes from an “interrogation” current pulse applied along the waveguide. The resulting strain pulse travels at sonic speed along the waveguide and is detected at the head of the sensing element.

The position of the magnet is determined with high precision and speed by accurately measuring the elapsed time between the application of the interrogation pulse and the arrival of the resulting strain pulse with a high-speed counter. The elapsed time measurement is directly proportional to the position of the permanent magnet and is an absolute value. Therefore, the sensor’s output signal corresponds to absolute position, instead of incremental, and never requires recalibration or re-homing after a power loss. Absolute, non-contact sensing eliminates wear, and guarantees the best durability and output repeatability.

All specifications are subject to change. Contact MTS Sensors for specifications and engineering drawings that are critical to your application. Drawings contained in this document are for reference only. Go to [www.mtssensors.com](http://www.mtssensors.com) for the latest support documentation and related media.

## G-Series Embedded Redundant Model GTE Sensors

### Product Overview and Specifications

#### Product overview

G-Series model GTE sensors are extremely robust and are ideal for continuous operation under harsh industrial conditions. The rod housing is capable of withstanding high pressures such as those found in hydraulic cylinders. G-Series redundant sensors provide accurate, linear-position measurement for applications that benefit from redundancy due to safety relevant functions.

G-Series Embedded Redundant sensors feature two independent measuring systems contained in one compact housing. Each measuring system contains its own channel with sensor element, power and evaluation electronics and output signal. Each channel has its own output cable.

All sensor elements are integrated in one pressure proofed, high-grade, 10 mm (0.39 in.) diameter stainless steel rod. The redundant sensor easily installs in applications measuring linear movements of control valves, linear drives, fluid cylinders and machines.

#### Product specifications

Parameters	Specifications
<b>OUTPUT</b>	
<b>Measured output variables:</b>	Position
<b>Resolution:</b>	<b>Analog:</b> Infinite (restricted by output ripple)
<b>Update times:</b>	< 1 ms (typical)
<b>Linearity deviation:</b>	< ± 0.02% full stroke (minimum ± 50 µm)
<b>Repeatability:</b>	< ± 0.001% of full stroke (minimum ± 2.5 µm)
<b>Hysteresis:</b>	< 4 µm
<b>Analog Outputs:</b>	2 output channels <b>Voltages (Fully adjustable):</b> 0 to 10, 10 to 0, -10 to +10, +10 to -10 Vdc (minimum controller load > 5k ohms) <b>Current (Fully adjustable):</b> 4 (0) to 20 mA, 20 to 4 (0) mA (min./max. load 0/500 ohms)
<b>Stroke Length:</b>	50 mm (2 in.) to 2540 mm (100 in.)
<b>ELECTRONICS</b>	
<b>Operating voltage:</b>	<b>+24 Vdc nominal:</b> (-15% / +20%) <b>Polarity protection:</b> up to -30 Vdc <b>Overvoltage protection:</b> up to 36 Vdc <b>Current drain:</b> 100 mA typical per channel <b>Dielectric withstand voltage:</b> 500 Vdc (DC ground to machine ground)
<b>Setpoints:</b>	<b>Setpoint adjustment (Null/Span):</b> 100% of electrical stroke length, 50 mm (2 in.) minimum distance between setpoints.

Parameters	Specifications
<b>ENVIRONMENTAL</b>	
<b>Operating conditions:</b>	<b>Operating temperature:</b> -20 °C (-4 °F) to +75 °C (167 °F) <b>Relative humidity:</b> 90% no condensation
<b>EMC test:</b>	<b>Emissions:</b> EN61326-1 <b>Immunity:</b> EN61326-1
<b>Shock rating:</b>	100 g (single hit) / IEC 60068-2-27 (survivability)
<b>Vibration rating:</b>	10 g / 10 to 2000 Hz, IEC 60068-2-6 (operational)
<b>WIRING</b>	
<b>Connection type:</b>	Integral cable
<b>ROD STYLE SENSOR (MODEL GTE)</b>	
<b>Electronic head:</b>	303 stainless steel
<b>Sealing:</b>	IP54
<b>Sensor rod:</b>	304L stainless steel
<b>Operating pressure:</b>	350 bar static, 690 bar peak (5000 psi static, 10,000 psi peak)
<b>Magnet types:</b>	Ring magnet or open-ring magnet
<b>AGENCY APPROVALS (OPTIONAL)</b>	
<b>Non-sparking:</b>	<b>IECEX:</b> IECEX BVS 13.00C3X Ex nA IIC T4 Gc  <b>ATEX:</b> II 3G Ex nA IIC T4 Gc 

## Output options

G-Series embedded redundant sensors are available with analog (voltage and current) outputs. The G-Series embedded redundant Model GTE Sensor provides two output channels.

### ANALOG (VOLTAGE/CURRENT)

G-Series analog sensors provide direct signals, including voltage (0 to 10 Vdc or -10 to +10 Vdc, forward or reverse acting) and current (4 to 20 mA, or 0 to 20 mA, forward or reverse acting). (see Figure 1). Both voltage and current outputs allow full adjustments of null and span setpoints (minimum 50.8 mm (2 in.) between setpoints). Since the outputs are direct, no signal-conditioning electronics are needed when interfacing with controllers or meters.

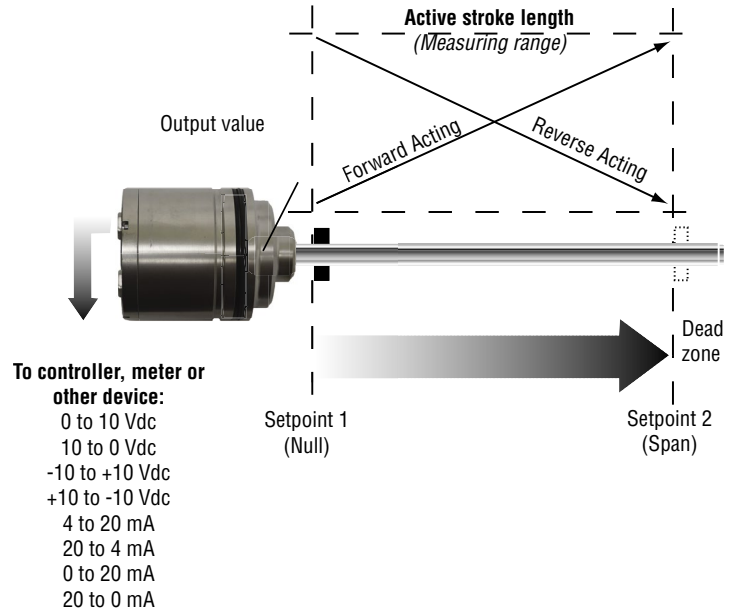

Figure 1. Single magnet analog output diagram

## Advanced communications and programmability

### SENSOR FIELD PROGRAMMING AND G-SERIES PC PROGRAMMING KIT

Temposonics® G-Series Embedded Redundant sensors are pre-configured at the factory by model code designation. For many applications no adjustments are required for normal sensor installation and operation. If, however, sensor parameter changes are desired while in the field, the G-Series Embedded Redundant sensor is easily programmed by using the G-Series PC Programming kit (see Figure 2).



Figure 3. G-Series PC Programming Kit, part no. 253311-1

G-Series PC setup software can be downloaded from [www.mtsensors.com](http://www.mtsensors.com). You can use the PC setup software to configure, diagnose, monitor and program your G-Series sensor in the field without opening the sensor's electronics housing.

This can simplify installation and commissioning, saving valuable time. Keeping the sensor electronics isolated ensures that seal integrity and the highest product reliability are maintained.

### G-Series Analog PC Programming Kit (part no.: 253311-1) includes the following components:

- Wall adapter style power supply (24 Vdc output)
- USB Serial converter box with USB cable to connect to PC
- Two connection cables:
  - Cable for sensor ordered with the D60 integral connector option.
  - Cable with quick connects for sensor ordered with the integral cable option.
- G-Series Analog PC Setup software, on CD-ROM (for Windows XP or higher)



The G-Series PC programming kit is not approved for hazardous area use. Use only in safe areas.

## G-Series Embedded Redundant Model GTE Sensors Monitoring, Diagnostics and Advanced Programmability

### G-Series PC setup and configuration software interface

#### VISUAL SOFTWARE INTERFACE

The G-Series PC Setup and configuration software provides a user-friendly interface (see 'Figure 3') along with the sensor's advanced technology enables the operator to take advantage of the following features:

- Built-in serial interfaces for robust hard-wired serial communication (RS-485).
- Remote programmability for operational modes and sensor parameters (see Table 1).

#### ANALOG (VOLTAGE/CURRENT) OUTPUT FEATURES

Voltage or current output mode

Voltage or current output range

Full adjustment for Null and Span setpoints

**Table 1.** Remote programmability and operational modes

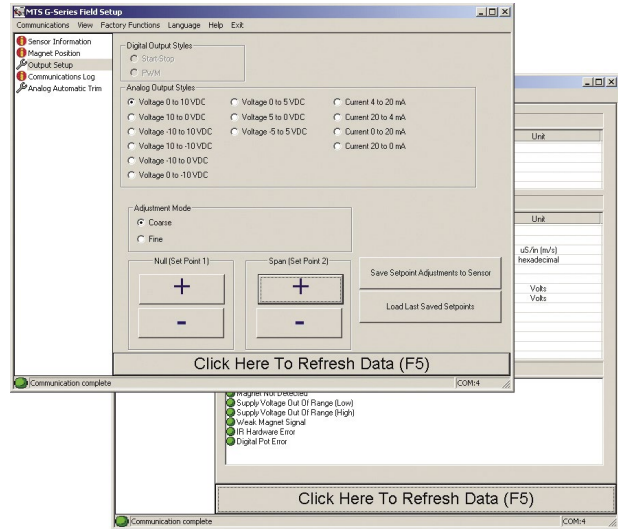

**Figure 3.** G-Series PC setup software interface examples

#### G-SERIES HANDHELD PROGRAMMER ACCESSORY FOR ANALOG OUTPUT

Programming for your G-Series analog output sensor can be achieved in the field using the G-Series Analog Handheld programmer accessory, part no. 253853 (see Figure 4).



**Figure 4.** G-Series Analog Handheld Programmer (part no.: 253853). Front and back views shown.



The G-Series handheld programmer is not approved for hazardous area use. Use only in safe areas.

Using the G-Series Analog Handheld Programmer, magnet positions and corresponding output values can be adjusted for the beginning of stroke (Setpoint 1) and for the end of stroke (Setpoint 2) that is actually needed for the specific application. These adjustments are easily done, even when the sensor is not directly accessible, by connecting the programmer to the sensor's integral cable or extension cable.

Additionally, the programmer has its own red and green LEDs to provide a remote display of the sensor's status and error diagnostics.

For detailed information refer to the G-Series Analog Handheld Programmer Operating Instructions (document part no.: 551024) available at [www.mtssensors.com](http://www.mtssensors.com).

## Models GTE rod-style sensor dimension references

Temposonics® G-Series Model GTE sensors offer modular construction and easy installation. Model GTE sensors are designed for mounting in applications where high pressure conditions exist (5000 psi continuous, 10,000 psi spike), such as inside hydraulic cylinders.

### MODEL GTE ROD-STYLE SENSOR WITH RING MAGNET (MAGNET ORDERED SEPARATELY)

*Drawing is for reference only, contact applications engineering for tolerance specific information.*

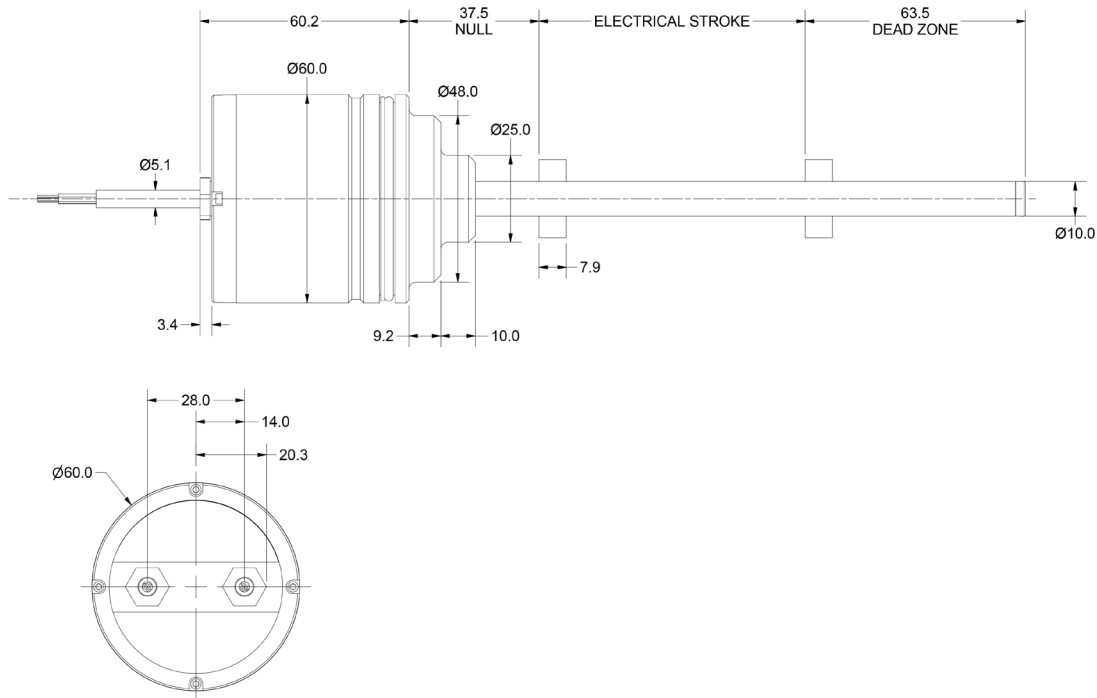
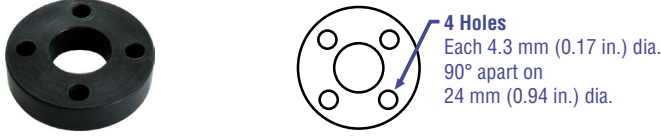
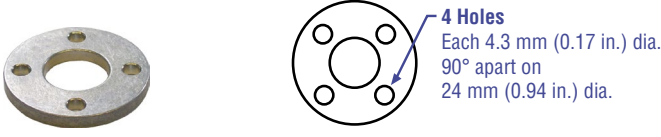

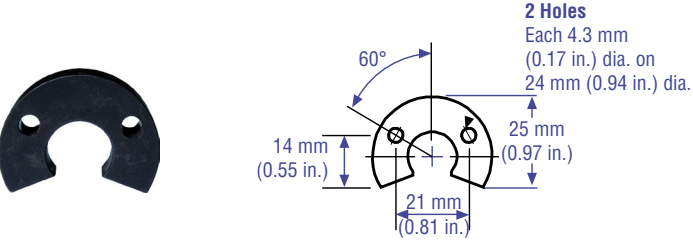

Figure 5. Model GTE sensor dimension reference

**G-Series Embedded Redundant Model GTE Sensors**  
**Standard Magnet Selections**

**Standard magnet selections (Model GTE)**

Magnets must be ordered separately with Model GTE position sensors. The standard ring magnet (part number 201542-2) is suitable for most applications.

<b>POSITION MAGNET SELECTIONS (Magnet must be ordered separately)</b> <i>(Drawing dimensions are for reference only)</i>		
<b>Magnet and magnet dimensions</b>	<b>Description</b>	<b>Part number</b>
	<p><b>Standard ring magnet</b>  <b>I.D.:</b> 13.5 mm (0.53 in.)  <b>O.D.:</b> 33 mm (1.3 in.)  <b>Thickness:</b> 8 mm (0.3 in.)  <b>Operating temperature:</b>                      - 40 °C to 100 °C</p>	201542-2
	<p><b>Magnet spacer</b>                      (Non-ferrous, use with ring magnet                      Part number: 201542-2)  <b>I.D.:</b> 14 mm (0.56 in.)  <b>O.D.:</b> 32 mm (1.25 in.)  <b>Thickness:</b> 3.2 mm (0.125 in.)</p>	400633
	<p><b>Ring magnet</b>  <b>I.D.:</b> 13.5 mm (0.53 in.)  <b>O.D.:</b> 25.4 mm (1 in.)  <b>Thickness:</b> 8 mm (0.3 in.)  <b>Operating temperature:</b>                      - 40 °C to 100 °C</p>	400533
	<p><b>Open-ring magnet, Style M</b>  <b>I.D.:</b> 13.5 mm (0.53 in.)  <b>O.D.:</b> 33 mm (1.3 in.)  <b>Thickness:</b> 8 mm (0.3 in.)  <b>Operating temperature:</b>                      - 40 °C to 100 °C</p>	251416-2

**Model GTE connections and wiring**

<b>Wire Color</b>	<b>Function / Analog output</b>
Gray	0 to 10, -10 to +10, or 4 to 20 mA, 0 to 20 mA or reverse acting: 10 to 0, 10 to -10 Vdc or 20 to 4 mA, 20 to 0 mA
Pink	Return for output
Yellow	Programming (RS-485+)
Green	Programming (RS-485-)
Red or Brown	Supply voltage (+Vdc)
White	DC ground (for supply)
Shield	Only connected on controller side

# G-Series Embedded Redundant Model GTE Sensors

## Ordering Information

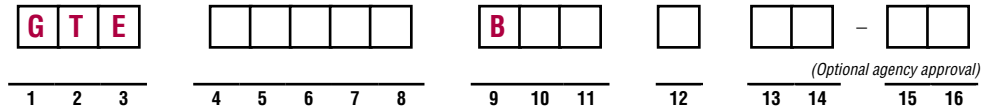

**SENSOR MODEL** \_\_\_\_\_ = **G T E** 1-3

**GTE** = embedded-redundant sensor

**STROKE LENGTH** \_\_\_\_\_ = \_\_\_\_\_ 4-8

\_\_\_\_ **M** = Millimeters  
(Encode in 5 mm increments)

\_\_\_\_ **U** = Inches and tenths  
(Encode in 0.1 in. increments)

**Stroke Length Note:**  
Model GTE sensor stroke range = 50 mm (2 in.) - 2540 mm (100 in.)

**CONNECTION TYPE** \_\_\_\_\_ = **B** \_\_\_\_\_ 9-11

**Integral cables:**  
**B** \_\_\_\_\_ = Integral cable, black santoprene jacket with pigtail termination (2X)  
**Cable length:**  
 Encode in feet if using US customary stroke length  
 Encode in meters if using metric stroke length  
 \_\_\_\_\_ = 3 (**03**) ft. or 1 (**01**) meter

**INPUT VOLTAGE** \_\_\_\_\_ = \_\_\_\_\_ 12

**1** = +24 Vdc (+20% / -15%) (Tamb max. 75 °C)

**OUTPUT** \_\_\_\_\_ = \_\_\_\_\_ 13-14

<b>V0</b> = 0 to +10 Vdc	<b>A0</b> = 4 to 20 mA
<b>V1</b> = +10 to 0 Vdc	<b>A1</b> = 20 to 4 mA
<b>V2</b> = -10 to +10 Vdc	<b>A2</b> = 0 to 20 mA
<b>V3</b> = +10 to -10 Vdc	<b>A3</b> = 20 to 0 mA

**Note:**  
Standard factory settings configure all outputs to be the same per the output option selected (when configuring the model number). If needed, an output can be individually reprogrammed in the field to best fit the application.

**AGENCY APPROVAL (OPTIONAL)** \_\_\_\_\_ = \_\_\_\_\_ 15-16

\_\_\_\_ = Non-approved version  
**EX** = Approved version

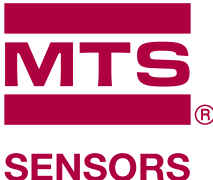

**LEGAL NOTICES**

**Document Part Number:**  
551386 Revision C (EN) 05/2016

MTS, Temposonics and Level Plus are registered trademarks of MTS Systems Corporation in the United States; MTS SENSORS and the MTS SENSORS logo are trademarks of MTS Systems Corporation within the United States. These trademarks may be protected in other countries. All other trademarks are the property of their respective owners.  
 Copyright © 2016 MTS Systems Corporation. No license of any intellectual property rights is granted. MTS reserves the right to change the information within this document, change product designs, or withdraw products from availability for purchase without notice. Typographic and graphics errors or omissions are unintentional and subject to correction. Visit [www.mtssensors.com](http://www.mtssensors.com) for the latest product information.

**LOCATIONS**

**USA**  
**MTS Systems Corporation**  
**Sensors Division**  
 3001 Sheldon Drive  
 Cary, N.C. 27513, USA  
 Tel. +1-919-677-0100  
 Fax +1-919-677-0200  
 info.us@mtssensors.com  
 www.mtssensors.com

**GERMANY**  
**MTS Sensor Technologie**  
**GmbH & Co. KG**  
 Auf dem Schüffel 9  
 58513 Lüdenscheid, Germany  
 Tel. +49-23 51-95 87 0  
 Fax +49-23 51-5 64 91  
 info.de@mtssensors.com  
 www.mtssensors.com

**JAPAN**  
**MTS Sensors Technology Corp.**  
 737 Aihara-machi,  
 Machida-shi,  
 Tokyo 194-0211, Japan  
 Tel. +81-42-775-3838  
 Fax +81-42-775-5512  
 info.jp@mtssensors.com  
 www.mtssensors.com

