

1) Manifold Configuration

Double solenoid valves always consume two solenoid outputs, while single solenoid valves consume either one or two solenoid outputs depending on the internal circuit board (Single or Double “Z-Board”). There are two different methods for determining if the manifold block has a single or double “Z-board”. The first method is to view the label on the valve manifolds. In Figure 1 below, the digits in red show the user which “Z-Board” is being used. If the digits are Z1 or Z5, then there is a single “Z-Board” within the manifold. If the digits are Z2 or Z6, then there is a double “Z-Board” within the manifold. If these digits are both zero, then the second method must be used. The second method is to view the label located under the valve. In Figure 2 below, the valves are removed from the manifold station to show the “Z-Board” labels.

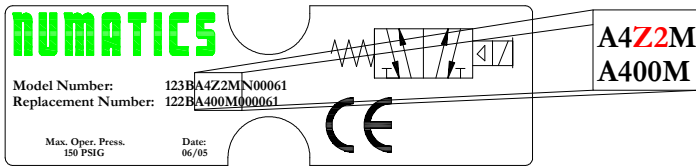

Figure 1- Top view of the label. The area of the part number in red determines which “Z-Board” is used.

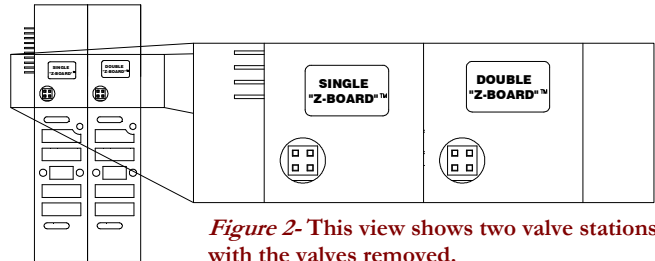
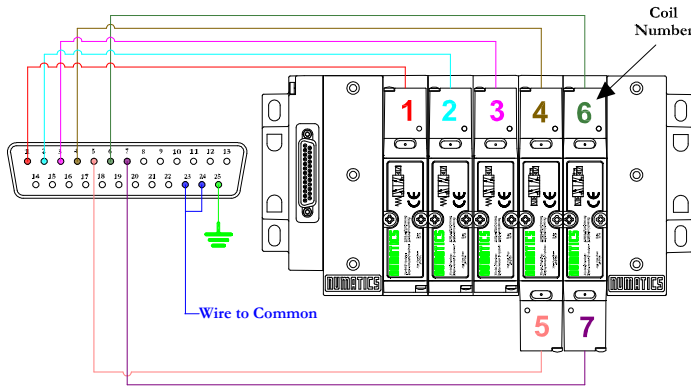

Figure 2- This view shows two valve stations with the valves removed.

The following examples show configurations using both a single and a double “Z-Board”. The valve station adjacent to the electrical connector is considered the first output point.

Example No. 1
("Z-Boards" configured identical to valve type)



Example No. 2
("Z-Boards" configured with all doubles)

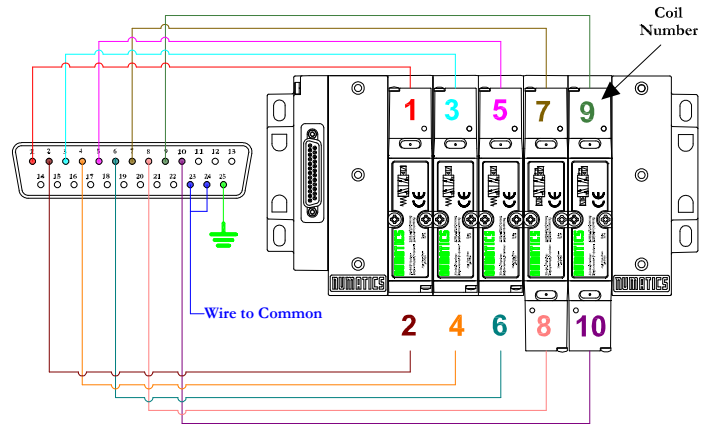

2) Sub-D Cable Wire Colors

Connector	Conductor	Connector	Conductor
Pin 1	Black	Pin 21	Orange/Green
Pin 2	White	Pin 22	Black/White/Red or Brown/White
Pin 3	Red	Pin 23	White/Black/Red or Yellow/Black
Pin 4	Green	Pin 24	Red/Black/White or Violet/White
Pin 5	Orange	Pin 25	Green/Black/White or Gray/Black
Pin 6	Blue	Pin 26	Orange/Black/White or Yellow
Pin 7	White/Black	Pin 27	Blue/Black/White or Violet
Pin 8	Red/Black	Pin 28	Black/Red/Green or Gray
Pin 9	Green/Black	Pin 29	White/Red/Green or Pink
Pin 10	Orange/Black	Pin 30	Red/Black/Green or Light Green
Pin 11	Blue/Black	Pin 31	Green/Black/Orange or Orange/White
Pin 12	Black/White	Pin 32	Orange/Black/Green or Pink/Black
Pin 13	Red/White	Pin 33	Blue/White/Orange or Pink/Green
Pin 14	Green/White	Pin 34	Black/White/Orange or Pink/Red
Pin 15	Blue/White	Pin 35	White/Red/Orange or Pink/Violet
Pin 16	Black/Red	Pin 36	Orange/White/Blue or Light Blue
Pin 17	White/Red	Pin 37	White/Red/Blue or Light Brown
Pin 18	Orange/Red	Not Used	Black/White/Green
Pin 19	Blue/Red	Not Used	White/Black/Green
Pin 20	Red/Green	Not Used	Red/White/Green



12 and 26 pole cables do not have color identification; each conductor is numbered the length of the cable.

3) Electrical Interface Pin-outs

25 Pin Sub-D Wiring Layout (AKJ)

Module Number
239-1174, 239-1175
(Male View)

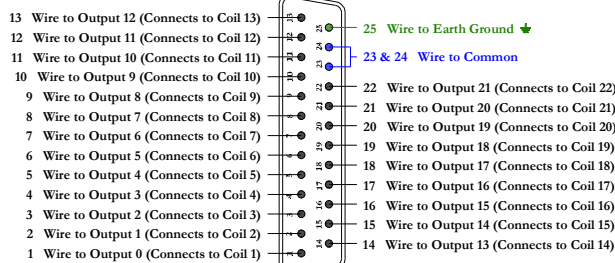
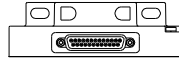

37 Pin Sub-D Wiring Layout (AKM)

Module Number
239-1180, 239-1181
(Male View)

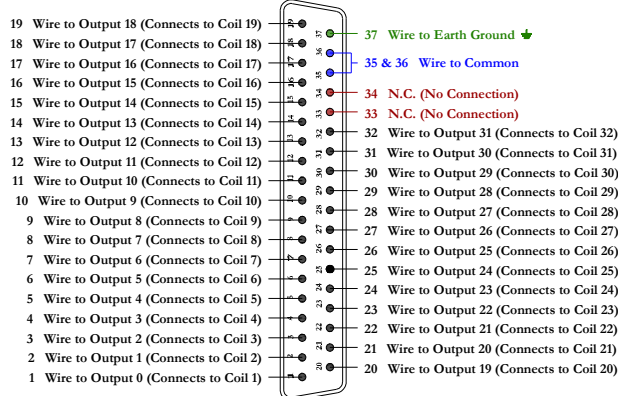
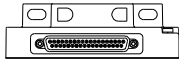

Terminal Strip Wiring Layout (AKF, AKT)

Module Number
239-1229, 239-1230, 239-1231, 239-1232

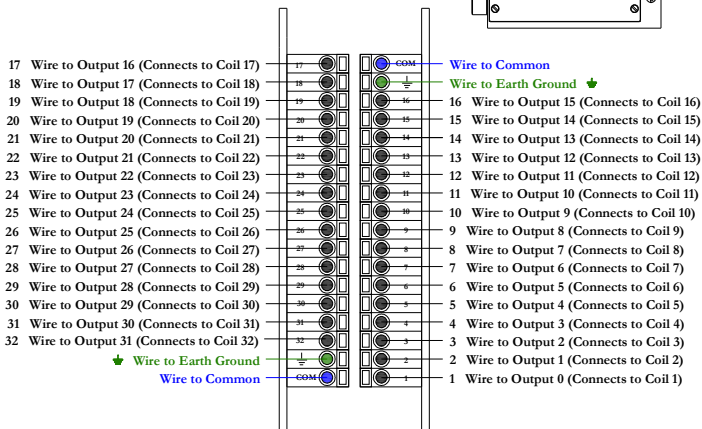
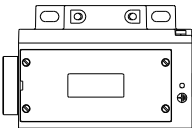

12 Pin Round Connector Wiring Layout (AKP)

Module Number
239-2115, 239-2116
(Male View)

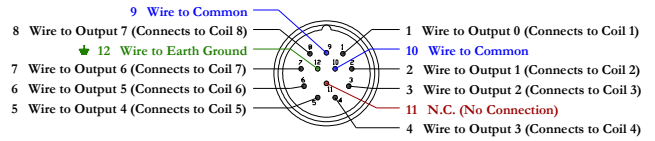
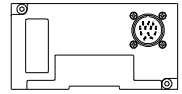

19 Pin Round Connector Wiring Layout (AKQ)

Module Number
239-2307, 239-2308
(Male View)

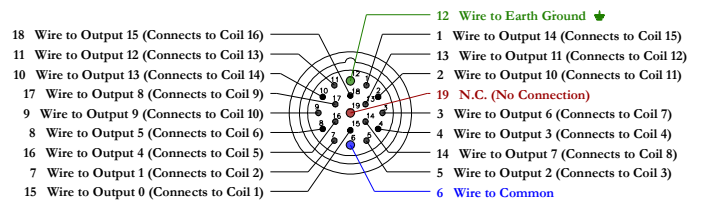
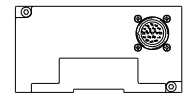

26 Pin Round Connectors Wiring Layouts (AKR)

Module Number
239-1184, 239-1185
(Male View)

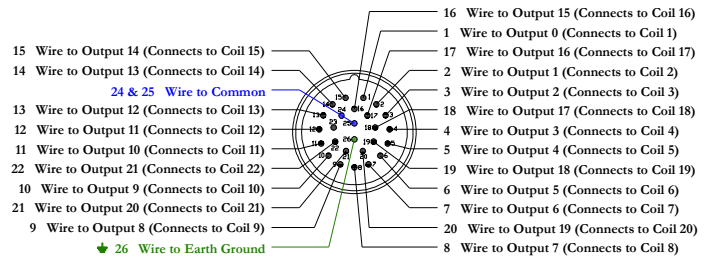
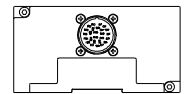

26 + 12 Pin Round Connectors Wiring Layouts (AKS)

Module Number
239-1376, 239-1377
(Male View)

