

rotork®

Keeping the World Flowing

SI Pro Actuators



Instructions for Safe Use, Installation,
Basic Setup and Maintenance

⚠ This manual contains important safety information. Please ensure it is thoroughly read and understood before installing, operating or maintaining the equipment.

PUB021-033-00
Date of issue 03/19

CE

The Rotork Setting Tool and Setting Tool *Pro* allows actuator control, indication and protection functions to be configured to suit site requirements. In addition, the new Rotork Bluetooth® Setting Tool also allows downloading of Datalogger and uploading/downloading of configuration files. Files are transferred to and from the Rotork Bluetooth® Setting Tool via Insight II.

It is essential that all the actuator settings are checked for compatibility with the valve, process and control system requirements before the actuator is put into service. Please read this publication before proceeding.

When Rotork personnel or nominated agents are contracted to carry out site commissioning and/or acceptance, documentation of commissioned actuator configuration can be made available for customer records.



Rotork Setting Tool



Rotork Setting Tool Pro



Rotork Bluetooth® Setting Tool

This manual provides instruction on:

- Electrical (local and remote) and optional manual operation.
- Preparation and installation of the actuator onto the valve.
- Subsequent commissioning and adjustment of the Basic Settings for correct valve operation.
- Commissioning and adjustment of the Configuration Settings to suit site-specific control and indication requirements.
- Maintenance and Troubleshooting.
- Sales and Service.

THE ROTORK SI *PRO* RANGE – A RELIABLE SOLUTION FOR ELECTRIC FAILSAFE AND MODULATING VALVE CONTROL THAT YOU CAN COMMISSION AND INTERROGATE WITHOUT REMOVING ELECTRICAL COVERS.

Using the supplied infrared / Bluetooth® Setting Tool to access the actuator set up procedures, non-intrusive setting of internal hydraulic pressure levels, position limits and all other control and indication functions can be made safely, quickly and conveniently, even in hazardous locations

Standard diagnostics information about the control system, valve and actuator status in the form of display icons and help screens.

Setup, Alarm and status text is available in English (default). Other languages are available upon request.

Instantaneous internal hydraulic pressure and position can be monitored on the actuator with a single key press of the Setting Tool.

The on board Datalogger captures operational and valve data enabling informed maintenance choices to be made. Insight II software for PC allows the Datalogger to be interrogated, as well as the complete actuator set up to be configured and recorded.

Visit our web site at www.rotork.com for more information on the SI, Insight II and other Rotork actuator ranges.

Identifying Actuator Parts

SI-1 Quarter-turn

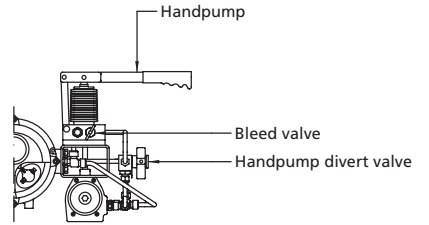
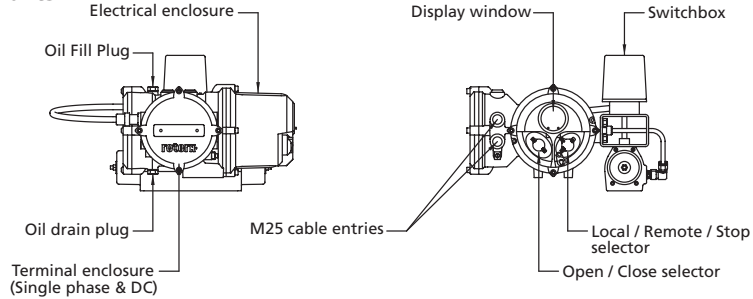

SI-2 Quarter-turn

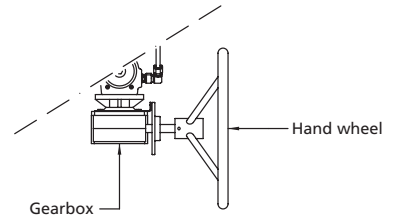
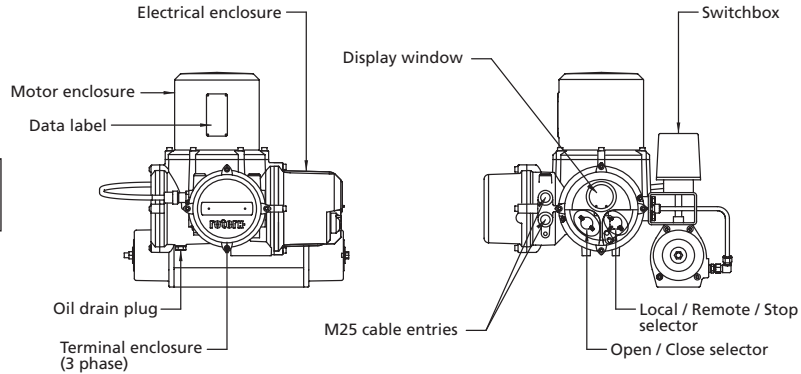

CONTENTS

Section	Page	Section	Page	Section	Page
1 Health and Safety	2	6.2 Removing Terminal Cover	13	9.2 Indication Contacts r1, r2 and r3	33
2 Storage	3	6.3 Cable Entry	13	9.3 General Settings	34
3 Operating your Skilmatic SI Pro Actuator	4	6.4 Connecting to Terminals	14	9.4 Digital Control	37
3.1 Electrical Operation	4	6.5 Replacing Terminal Cover	14	9.5 ESD / Partial Stroke Settings	38
3.2 Display – Local Indication	4	6.6 Prior to Commissioning	14	9.6 Analogue Control 1	42
3.3 Display Status Indication – Travel	5	7 Commissioning	15	9.7 Analogue Control 2	44
3.4 Display Status Indication – Control	5	7.1 The Setting Procedure	15	9.8 Interrupter Timer	46
3.5 Display Alarm Indication	6	7.2 The Setting Tool (old version)	16	9.9 Service	49
4 Optional Manual Operation	7	7.3 The Setting Tool <i>Pro</i>	17	9.10 Bus System Option Pakscan	51
5 Mounting the Actuator	8	7.4 The Rotork Bluetooth® Setting Tool	18	9.11 Bus System Option Modbus [OP]	54
5.1 Lifting	8	7.5 Entering the Actuator Setting Procedure	20	9.12 Bus System Option Profibus DP [OP]	57
5.2 Mounting Orientation SI-Q Actuators	9	7.6 Setting Mode – Password	20	9.13 Bus System Option DeviceNet	60
5.3 Fitting SI-Q Actuator to Valve	9	7.7 New Password [PC]	20	9.14 Bus System Positioning Control Settings	63
5.4 Mechanical Travel Adjustment of Q31 & Q41 Actuators	9	7.8 Checking Mode	20	10 Maintenance, Monitoring and Troubleshooting	67
5.5 Mechanical Travel Adjustment of Q51 to Q80 Actuators	10	7.9 Bluetooth Diagnostics & Configuration	21	10.1 Maintenance, Monitoring and Troubleshooting	67
5.6 Mechanical Travel Adjustment Q110-130	10	7.10 Partial Stroke Test	21	10.2 Environmental	68
5.7 Mounting Orientation SI-L Actuators	11	7.11 Full Stroke Test	22	11 Help Screens	69
5.8 Mounting SI-L to Valve	12	7.12 Crossroad [Cr]	22	12 Weights and Measures	75
6 Cable Connections	13	7.13 The Actuator Display – Setting/Checking Mode	22	13 Actuator Nameplate	77
6.1 Earth/Ground Connections	13	7.14 Returning to Valve Position Display	23	14 Hazardous Area Approvals	77
		8 Commissioning – Basic Functions	24	14.1 Approved Fuses	78
		Viewing the Basic Settings	25	15 Special Conditions of Safe Use	78
		8.1 Menu Structure	31		
		9 Configuration Settings	32		
		Configuration Settings Contents	32		
		9.1 Accessing Configuration Settings	32		

Health and Safety

This manual is produced to enable a competent user to install, operate, adjust and inspect Rotork SI range of actuators. Only persons competent by virtue of their training or experience should install, maintain and repair Rotork actuators. Work undertaken must be carried out in accordance with the instructions in this and other relevant manuals. The user and those persons working on this equipment should be familiar with their responsibilities under any statutory provisions relating to the Health and Safety of their workplace. Due consideration of additional hazards should be taken when using the SI range of actuators with other equipment. Should further information and guidance relating to the safe use of the Rotork SI range of actuators be required, it will be provided on request.

The electrical installation, maintenance and use of these actuators should be carried out in accordance with the National Legislation and Statutory Provisions relating to the safe use of this equipment, applicable to the site of installation.

For the UK: Electricity at Work Regulations 1989 and the guidance given in the applicable edition of the

“IEE Wiring Regulations” should be applied. Also the user should be fully aware of his duties under the Health and Safety Act 1974.

For the USA: NFPA70, National Electrical Code ® is applicable.

The mechanical installation should be carried out as outlined in the manual and also in accordance with relevant standards such as British Standard Codes of Practice. If the actuator has nameplates indicating that it is suitable for installation in hazardous areas then the actuator may be installed in Zone 1 and Zone 2 classified hazardous area locations only. It should not be installed in hazardous area locations with an ignition temperature less than 135 °C, unless suitability for lower ignition temperatures has been indicated on the actuator nameplate.

It should only be installed in hazardous area locations compatible with the gas groups stated on the nameplate.

The electrical installation, maintenance and the use of the actuator should be carried out in accordance with the code of practice relevant for that particular hazardous area certification.

No inspection or repair should be undertaken unless it conforms to the specific hazardous area certification requirements. Under no circumstances should any modification or alteration be carried out on the actuator as this could invalidate the actuators hazardous area approval certification.

Access to live electrical conductors is forbidden in the hazardous area unless this is done under a special permit to work, otherwise all power should be isolated and the actuator moved to a non-hazardous area for repair or attention.

WARNING: Compressed Springs

All springs within the SI range of actuators are pre-compressed. Springs must not be removed from the actuator.

WARNING: Hydraulic Fluid

SI actuators are filled with hydraulic fluid. See actuator data label for type of oil supplied.

Should there be a requirement to change the fluid, then the appropriate protective clothing including gloves and safety glasses must be worn. Used hydraulic fluid must be disposed of safely (see environmental section).

Note: the PRODUCT SAFETY DATA SHEETS covering the type of hydraulic oil supplied by Rotork for use within the supplied power units are available on request.

WARNING: Operating by Hand

With respect to optional manual operation of Rotork actuators, see warnings in section 4.

 **WARNING:** Actuator may start and operate when remote is selected. This will be dependent on remote control signal status and actuator configuration.

 **WARNING:** This actuator must only be located in areas where the risk of impact to the viewing window is low.

Actuator Materials

SI-1-Q31 to SI-2-Q80 (SI-2.1-Q80)

Power unit:	Aluminium
Actuator body:	Aluminium
Drive shaft:	Stainless steel (Q31-61) Plated steel (Q70-80)
Switchbox:	Aluminium
Piping:	Stainless steel (hard piped)
External fasteners:	Stainless steel
Paint finish:	Standard 2-pack epoxy silver grey (150 microns thick)

SI-2-Q110 to Q130 (SI-2.1-Q110 to Q130)

Power unit:	Aluminium
Actuator body:	Carbon steel
Drive shaft:	Carbon steel
Switchbox:	Aluminium
Piping:	Stainless steel (Hard piped)
External fasteners:	Stainless steel
Paint finish:	Standard 2-pack epoxy silver grey (150 microns thick)

SI-1-L and SI-2-L (SI-2.1-L) All sizes

Power unit:	Aluminium
Actuator body:	Steel
Piston rod:	Stainless steel
Piping:	Stainless steel (Hard piped)
External fasteners:	Stainless steel
Paint finish:	Standard 2-pack epoxy silver grey (150 microns thick)

The user must ensure that the operating environment and any materials surrounding the actuator cannot lead to a reduction in the safe use of, or the protection afforded by, the actuator.

Where appropriate the user must ensure the actuator is suitably protected against its operating environment.

Products manufactured by Rotork do not present a hazard to health under normal conditions of storage, distribution and use, provided that good industrial and hygiene procedures are followed.

If your actuator cannot be installed immediately, store it in a dry place until you are ready to connect incoming cables.

If the actuator is to be installed, but not immediately cabled, it is recommended that any plastic cable entry transit plugs be replaced with a suitable metal plug.

The double-sealed construction of the terminal compartment will preserve internal electrical components perfectly if left undisturbed.

It is not necessary to remove the electrical compartment covers in order to commission the SI actuator.

Rotork will not accept responsibility for deterioration caused on site once the covers are removed.

Every Rotork actuator has been fully tested before leaving the factory to give years of trouble free operation, providing it is correctly commissioned, installed and sealed.

Do not store in temperatures beyond the normal operating range as stated on data label.

3

Operating your SI Actuator

3.1 Electrical Operation

Check that the power supply voltage agrees with that on the actuator nameplate. Switch on power supply. It is not necessary to check phase rotation (on 3-phase units).

⚠ WARNING: Do not operate the actuator electrically without first checking, using the setting tool that at least the Basic Settings have been made. Refer to section 8.

Selecting Local/Stop/Remote Operation

The red selector enables either Local or Remote control, lockable in each position using a padlock with a 6.5mm hasp.

When the selector is locked in the Local or Remote positions the Stop facility is still available. The selector can also be locked in the Stop position to prevent electrical operation by Local or Remote control.

Local Control



With the red selector positioned at Local (anti-clockwise) the adjacent black knob can be turned to select Open or Close. For Stop, turn red knob clockwise. Figure 3.1.



Fig. 3.1.

Remote Control



Rotate the red selector to the Remote position (clockwise), this allows remote control signals to operate the actuator. Local Stop can still be used by turning the red knob anti-clockwise.

3.2 Display-Local Indication

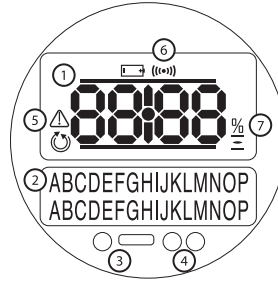

Fig. 3.2 The Actuator Display

The display consists of:

1. Position Display - This is the main 7-segment position display with icons.
2. Text Display - This is a 2 line, 16 characters dot matrix display which allows text to be used to compliment the position display and icons.
3. Infra Red LED's.
4. 2 x LED's for position indication.
5. Alarm Icon - This will be displayed for Valve, Control, and Actuator alarms. Alarm indication is supported by fault description text in the lower display.

6. IR Icon - This icon flashes during infra red communication activity.

7. Percentage Open Icon - This icon will be displayed when a Percentage Open value is in the upper display.

On power up the actuator's liquid crystal display screen is back-lit with an amber light and one of the indicator LED's will be on, dependent on position. The display screen will show percentage open or an end of travel symbol. (See figures 3.3, 3.4 and 3.5)

As standard, the red LED signifies valve open, amber intermediate, and green valve closed. Open and closed colour functions can be reversed on request.

Open

The Red LED will be lit, the open symbol and "Open Limit" will be displayed.

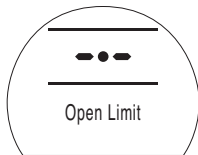

Fig. 3.3

Mid Travel

The Amber LED will be lit, percentage open value will be shown and "Stopped" will be displayed when there is no actuator movement.



Fig. 3.4

Closed

The Green LED will be lit, closed symbol and "Closed Limit" will be displayed.

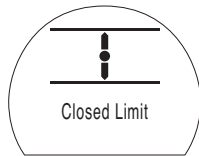

Fig. 3.5

LED Indicators

⚠ WARNING: Mid Travel LED colour may be affected by viewing angle and lighting level.

The Close LED colour can be changed to red if required. Refer to section 9.3.

3.3 Display Status Indication – Travel

The SI display provides real time status indication. The top line of the text display is reserved for travel status indication. Figure 3.6 shows the travel status example **Closed Limit**.

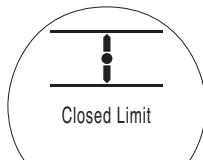

Fig. 3.6

Available travel status conditions displayed:

- **Closed Limit** Actuator has reached the set closed limit position.
- **Open Limit** Actuator has reached the set open limit position.
- **Moving Open** Actuator is traveling in the open direction.
- **Moving Closed** Actuator is traveling in the closed direction.
- **Stopped** Actuator has stopped in a mid travel position, indicated in the top display (%open).

- **Timer Active** Interrupter Timer option enabled only. Interrupter Timer has stopped the actuator mid travel for a period equal to the set Timer Off time. Refer to section 9.8.

3.4 Display Status Indication – Control

The bottom line of the text display is reserved for control status indication and is displayed for approximately 2 seconds after the control mode or signal is applied. Figure 3.7 shows the control status example **Remote Control**.

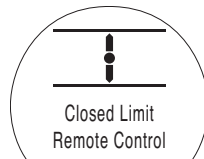

Fig. 3.7

Available control status conditions displayed:

- **Local Control** Local control selected - red selector.
- **Local Stop** Local stop selected - red selector.
- **Remote Control** Remote control selected - red selector.

- **Local Close** Local close signal applied – black selector.
- **Local Open** Local open signal applied – black selector.
- **Remote Close** Remote close (hardwired or analogue) signal applied.
- **Remote Open** Remote open (hardwired or analogue) signal applied.
- **Remote ESD** Remote hardwired emergency shut down signal applied.
- **Remote Bus Open** Remote Bus * open signal applied.
- **Remote Bus Close** Remote Bus* close signal applied.
- **Remote Bus ESD** Remote Bus* emergency shut down signal applied.
- **BT Connected** The actuator is connected via Bluetooth to either a setting tool or PC.

* *Bus Control option fitted may be Pakscan, Profibus, Modbus, DeviceNet or Foundation Fieldbus. Refer to actuator wiring diagram.*

The general alarm icon will be supported with text in the bottom line indicating the particular alarm, or if more than one is present, each alarm will be displayed in sequence.

Figure 3.8 shows the status example **MID TRAVEL OP** (Mid Travel Over Pressure).



Fig. 3.8

Available alarm conditions displayed:

Valve Alarms

- **OP IN MID POS** - Tripped off on pressure while moving in either direction between electrical limits after a signal to move.
- **OP AT LIMIT** - Tripped off on pressure while moving in either direction between the electrical limit and the mechanical end stop after a signal to move.
- **STALL IN MID POS** - No movement detected between electrical limits after a signal to move.
- **STALL AT LIMIT** - No movement detected

between the electrical limit and the mechanical end stop after a signal to move.

Control Alarms

- **DEMAND FAULT** - This fault indicates that the analogue demand signal has dropped below half the minimum set demand signal. In a 4-20 mA system the demand signal has dropped below 2 mA, or it goes above 22mA.
- **PS UNABLE TO RUN** - The actuator may not be at the correct limit to start the test or a new command was issued before the test was complete.
- **MANUAL RESET ON** - The actuator needs to be manually reset after either a ESD command or mains failure. *Refer to 9.5 ESD Manual Reset.*
- **ESD ACTIVE** - When present the ESD signal overrides all local and remote control signals. Once the ESD action is carried out operation is inhibited while the ESD signal is maintained. *Refer to 9.5 ESD Action.*

Actuator Alarms

- **CONFIG ERROR** - There may be an error in the configuration (set up) of the actuator. Check and reset basic setting and check configuration settings.
- **ELECTRONIC FAULT** - A hardware fault is

caused by an internal fault on the Main PCBA which prevents it from reading its inputs. This is critical and inhibits operation. This fault may be cleared by removing the mains power from the actuator and waiting for 20 seconds.

- **LOCAL CONTROL FAIL** - This indicates a fault caused by a either a Main Board failure, local control switch failure or conflicting signals from the switches. For example, both Local and Remote or Open and Close selected simultaneously.
- **SOL DRIVE FAULT** - Contact Rotork.
- **POS SENSOR FAULT** - Detected failure in the position sensing system – contact Rotork.
- **PRES SENSE FAULT** - Detected failure in the pressure sensing system – contact Rotork.
- **WRONG DIRECTION** - This indicates that the actuator has started to move in the opposite direction to the given command. When this occurs the actuator is stopped.
- **PS ERROR** - This indicates that a fault occurred while the actuator was attempting a partial stroke.
- **OPTION CH 1 FAULT** - Contact Rotork.
- **OPTION CH 2 FAULT** - Contact Rotork.
- **EEPROM MISSING** - Contact Rotork.

3.5 Display Alarm Indication

The SI display provides alarm indication in the form of text and alarm icons.

General Alarm:



Optional manual operation may have been specified for your SI actuator.

For all SI-1-Q and SI-2-Q70 & Q80 (SI-2.1-Q70 & Q80), actuators, optional manual operation is provided with either a handwheel operated gearbox or a hydraulic hand pump.

For SI-2-Q110 to Q130 (SI-2.1-Q110 to Q130), actuators, optional manual operation is provided by a hydraulic hand pump.

For all SI-1-L and SI-2-L (SI-2.1L), actuators, optional manual operation is provided by a hydraulic hand pump.

⚠ WARNING:
Manual override operation should only be carried out when there is no power supplied to the actuator.

Gearbox Operation

For Fail-closed actuators (spring acts in clockwise direction when looking from above the actuator), the hand wheel should be rotated anti-clockwise to open the actuator. Ensure the hand wheel is fully rotated clockwise before switching power back to the actuator.

For Fail-open actuators (spring acts in anti-clockwise direction when looking from above the actuator), the hand wheel should be rotated clockwise to close the actuator. Ensure the hand wheel is fully rotated anti-clockwise before switching power back to the actuator.

Where a gearbox is fitted, ensure the gearbox travel stops are set to limit gearbox rotation. Ensure the gearbox cannot be driven against the actuator stops as this can cause damage to the actuator. To adjust, remove the plastic cap and use an appropriate Allen (hex.) key. Rotate clockwise to reduce travel and anti-clockwise to increase travel.



WARNING:

With respect to optional handwheel operation of SI actuators, under no circumstances should any additional lever device such as a wheel key or wrench be applied to the handwheel in order to develop additional force when operating the valve as this may cause damage to the valve and/or actuator or may cause the valve to become stuck in the end of travel position or against an obstruction.

There is also a locking mechanism fitted to the gearbox to allow it to be locked in position by means of a padlock. It is recommended that a padlock is fitted for actuators being used in an ESD application.



Hand pump Operation

A 3-way, 2-position ball valve is used to select manual operation (see label attached to ball valve for position). Once the ball valve is positioned in manual the hand pump can then be used to hydraulically move the actuator. To move the actuator by means of the spring, release a small needle valve on the side of the hand pump. Close the needle valve before using the hand pump again or transferring back to auto operation.

Power to the actuator should be removed before operating the hand pump. Return the actuator to the fail-safe condition before restoring power to the actuator.



WARNING:

See specific manual override label as supplied with actuator, for manual override procedure.

For units fitted with an external solenoid valve, an extra isolating valve is fitted inline with the valve, this must be set to 'Manual' to operate the manual override.

An isolation valve is also fitted for fail in position actuators, this must be set to 'Manual' to operate the manual override.

There is also a locking mechanism fitted to each ball valve to allow it to be locked in position by means of a padlock. It is recommended that a padlock is fitted for actuators being used in an ESD application.

5.1 Lifting

⚠ WARNING:
Refer to Weights and Measures,
section 12 for actuator weight.

Ensure the valve is secure before fitting the actuator as the combination may be top heavy and therefore unstable.

SI-1-Q31 to SI-2-Q80 (SI-2.1-Q80), quarter- turn actuators should be lifted between the power unit and the mounting bracket. (See figure 5.1.)

SI-2-Q110 to Q130 (SI-2.1-Q110 to Q130), actuators should be lifted using the two lifting eyes, located on the spring can and cylinder end flange.

SI-1-L and SI-2-L (SI-2.1L), actuators should be lifted using the base plate beneath the cylinder and the power unit (See figure 5.2.)

In no circumstances should hydraulic piping or electrical cabling be used for lifting purposes.

If it is necessary to lift the actuator using mechanical lifting equipment, certified slings should be attached as indicated in figure 5.1 for SI-Q actuators and figure 5.2 for SI-L actuators.

At all times trained and experienced personnel should ensure safe lifting, particularly when mounting actuators.

⚠ WARNING: The actuator should be fully supported until complete valve shaft engagement is achieved and the actuator is secured to the valve mounting flange.

Actuator to valve fixing must conform to material specification ISO Class 8.8, yield strength 628 N/sq mm.

⚠ WARNING: Do not lift the actuator and valve combination via the actuator. Always lift the valve/ actuator assembly via the valve.

Each assembly must be assessed on an individual basis for safe lifting.

See SI-Q and SI-L data sheet for actuator base and mounting dimensions.



Fig. 5.1.

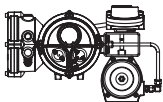

Fig. 5.2.

5.2 Mounting Orientation SI-Q Actuators

SI-1-Q

SI-1-Q actuators can be mounted in the positions shown below.



RECOMMENDED: The actuator can be mounted and serviced in this position.

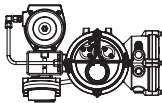

PERMITTED: Modifications need to be made if mounting in this orientation. Consult Rotork.

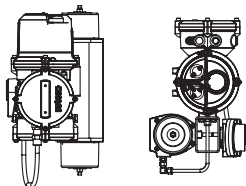

PERMITTED: The actuator can be mounted in these orientations but will have to be removed for servicing.

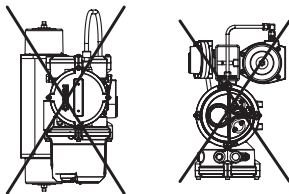

NOT PERMITTED: The actuator must NOT be mounted in these orientations.

SI-2-Q

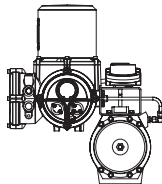

The SI-2-Q (SI-2.1-Q), actuators must always be mounted in the vertical position as shown. Please note the mounting bracket can be altered for different mounting orientations.

5.3 Fitting SI-Q Actuator to Valve

The standard SI-1-Q31 to SI-2-Q80 (SI-2.1-Q80), actuators are supplied machined to suit a close coupled ISO 5211 mounting having a square female drive and a selection of two mounting PCD's as detailed in the appropriate actuator data sheet.

The SI-2-Q110 to Q130 (SI-2.1-Q110 to Q130), actuator is supplied with 8 mounting holes and a bore & key drive. See SI-2-Q (SI-2.1-Q), data sheet for more information.

Ensure the plastic guide ring is removed from the actuator mounting face before fitting to the valve or valve adaption. Where a gearbox is fitted, ensure the gearbox shaft is correctly supported for full engagement within the actuator.

If the actuator cannot be mounted directly on to the valve, a separate box bracket and coupling will be required for mounting the actuator.

Before fitting the actuator, ensure that the valve is in the Fail or Start position and fit the coupling on the valve, ensuring that the drive is in the correct orientation.

Lower the actuator on to the valve, making sure that the drive is properly located.

Fit securing bolts, but before tightening ensure that the actuator and valve are properly aligned.

5.4 Mechanical Travel Adjustment of Q31 & Q41 Actuators

Fail-closed actuators can only have the travel adjusted at the open limit. Fail-open actuators can only have the travel adjusted at the closed limit. The adjustment is $\pm 3^\circ$. Giving a overall maximum rotation of 93° .

Adjustment Procedure – Spring Cap

- Loosen the lock nut.
- Adjust the stop bolt clockwise for reduced rotary motion and anti-clockwise for increased motion.
- Tighten the lock nut.

⚠ WARNING: *Q41 actuators have two travel adjustment screws. It is important that both screws are adjusted equally to ensure that both are in contact with the piston in question.*

5.5 Mechanical Travel Adjustment of Q51 to Q80 Actuators

Fail Closed Actuators – Use adjustment screw A for closed position and adjustment screw B for open position.

Fail Open Actuators – Use adjustment screw B for closed position and adjustment screw A for open position.

Actuators can be adjusted by $\pm 3^\circ$ in both open and closed position. Giving a overall maximum rotation of 96° .

Adjustment Procedure

- Loosen the lock nut.
- Adjust the stop bolt clockwise or anti-clockwise to reduce or increase rotation.
- Replace O-ring as it may have been damaged during adjustment.
- Tighten the lock nut.

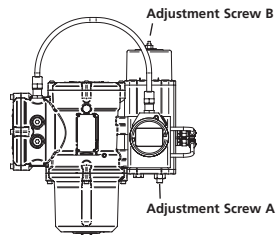

Q51 & Q70 Actuators

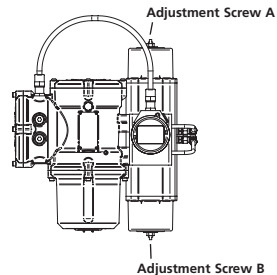

Q60, Q61 & Q80 Actuators

5.6 Mechanical Travel Adjustment Q110-130

Fail-closed actuators are adjusted by using the stop bolt in the hydraulic cylinder for the closed limit and in the spring canister for the open limit.

Fail-open actuators are adjusted by using the stop bolt in the hydraulic cylinder for the open limit and in the spring canister for the closed limit.

Actuators can be adjusted by $\pm 5^\circ$ in both open and closed position. Giving a overall maximum rotation of 100° .

Adjustment procedure - Hydraulic cylinder

- Remove the stop bolt cover and loosen the stop nut.
- Adjust the stop bolt clockwise for reduced rotary motion and anti clockwise for increased rotary motion.
- Once the desired position is achieved, tighten the stop nut, ensuring that the sealing washer is properly centred on the shaft and seated in the machined recess in the flange.
- Re-install the stop cover, ensuring that the sealing washer is properly centred on the shaft and seated in the machined recess in the stop cover.

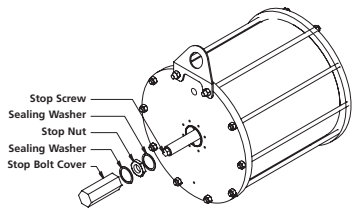

Adjustment procedure - Spring Canister Adjustment

- Remove the spring stop cap.
- Adjust the stop bolt clockwise for reduced and anti-clockwise for increased rotary motion.
- Once the desired position is achieved, replace the spring stop cap.

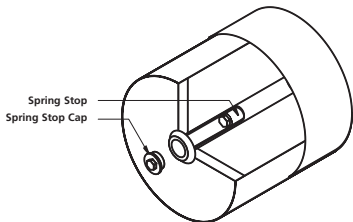

5.7 Mounting Orientation SI-L Actuators

SI-1-L

SI-1-L actuators can be mounted in the positions shown below.

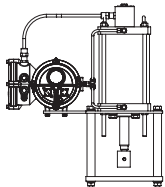

RECOMMENDED: The actuator can be mounted and serviced in this position.

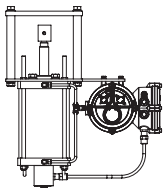

PERMITTED: Consult Rotork. Modifications need to be made if mounting in this orientation.

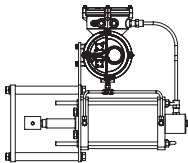
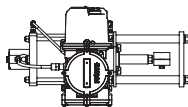

SI-2-L

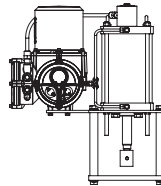

The SI-2-L (SI-2.1L), actuators must always be mounted in the vertical position as shown. The mounting bracket can be altered for different mounting orientations.

PERMITTED: The actuator can be mounted in these orientations. The unit will have to be removed for servicing

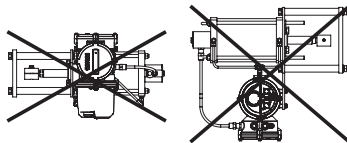

NOT PERMITTED: The actuator must NOT be mounted in these orientations.

5.8 Mounting SI-L to Valve

The standard actuator is supplied with the cylinder mounted on a base plate that is machined to accept four pillars concentric with the output shaft. In addition, the following must be provided to attach the actuator to the valve: four pillars, a valve mounting plate, and a split coupling adaptor to fit the end of the piston rod to the valve spindle.

Details of the actuator base and output shaft dimensions can be found in the applicable actuator data sheet.

There are no adjustable, mechanical end stops fitted to linear actuators.

Spring-to-extend actuator piston rod

(Valve stem down to close – fail closed)

- Ensure that the valve is fully closed.
- Remove the lock nuts or clamp from the valve bonnet and stem.
- Lower the actuator onto the valve.
- Replace the lock nuts or clamp on to the valve bonnet and tighten to the manufacturers recommended torque.
- Retract the actuator piston rod by 3 to 5mm so that the actuator pre-loads the valve seat. This can be accomplished by applying a temporary power supply to the actuator.
- Ensuring that the valve is still fully closed, fit the split coupling to clamp the actuator piston rod to the valve stem.

Spring-to-retract actuator piston rod

(Valve stem down to close – fail open)

- Ensure that the valve is fully open.
- Remove the lock nuts or clamp from the valve bonnet and stem.
- With the actuator output shaft fully retracted, lower the actuator onto the valve. Make sure that the actuator piston rod is clear of the valve stem.
- Replace the lock nuts or clamp on to the valve bonnet and tighten to the manufacturer's recommended torque.
- Ensure that the valve is still in the fully open position and fit the split coupling to clamp the actuator piston rod to the valve stem.

**WARNING:**

Ensure all power supplies are isolated before removing actuator covers.

Check that the supply voltage is the same as that stated on the actuator nameplate.

A switch or circuit breaker must be included in the wiring installation to the actuator. The switch or circuit breaker shall be mounted as close to the actuator as possible and shall be marked to indicate that it is the disconnecting device for that particular actuator. The actuator must be protected with a suitably rated overcurrent protection device as defined on the applicable wiring diagram.

6.1 Earth/Ground Connections

An M6 earth stud is located adjacent to the conduit entries for attachment of an external protective earthing strap. An internal earth terminal is also provided on the terminal bung, however it must not be used alone as the protective Earth Connection.

6.2 Removing Terminal Cover

Using a 6mm hexagon key loosen the four captive screws evenly. Do not attempt to lever off the cover with a screwdriver as this will damage the o-ring seal and may damage the flamepath on a certified unit.



Fig. 6.1.

A plastic bag in the terminal compartment contains the following:

- Terminal screws and washers.
- Spare cover o-ring seal.
- Wiring diagram.
- Instruction book.

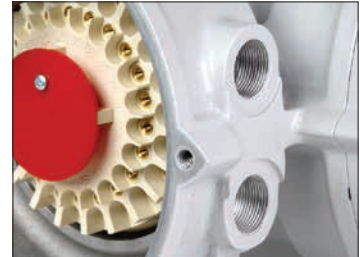

Fig. 6.2.

6.3 Cable Entry

The cable entries on the actuator terminal housing are tapped either M20 x 1.5P or M25 x 1.5P.

Only appropriate certified Explosion-Proof entry reducers, glands or conduit may be used in hazardous locations.

Remove any red plastic transit plugs. Make cable entries appropriate to the cable type and size. Ensure that threaded adaptors, cable glands or conduit are tight and fully waterproof. Seal unused cable entries with a steel or brass threaded plug. In hazardous areas an appropriately certified threaded blanking plug must be used.

6.4 Connecting to Terminals

⚠ On Ex dbeb enclosure units connections to the power and control terminals must be made using AMP type 160292 ring tabs for power and earth terminals and AMP type 34148 ring tabs for the control terminals.

Refer to the wiring diagram inside the terminal cover to identify functions of terminals. Check that supply voltage is the same as that marked on the actuator nameplate.

Remove the red power terminal screen.

Begin by connecting these cables and replace the red power terminal screen.

When all connections are made, ensure wiring diagram is replaced in the terminal compartment.

6.5 Replacing Terminal Cover

Ensure cover o-ring seal and spigot joint are in good condition and lightly greased before re-fitting cover.

6.6 Prior to Commissioning

Depending on how it has been shipped and stored since leaving the Rotork factory, it may be necessary to bleed the actuator. Follow the procedure below for a fail-closed actuator:

- Fully open and close the actuator using the local controls.
- Turn the selector knob to Stop.
- Remove the oil fill plug. If no air escapes then the actuator is fully bled. If air does escape then the actuator will need to be cycled again.
- Replace the oil fill plug and turn the selector knob back to Local.
- Cycle the actuator fully open and close again.
- Turn the selector knob to Stop and remove the oil fill plug.
- Repeat this process until no air escapes when the oil fill plug is removed.

⚠ WARNING: Ensure the oil fill plug is always tight before stroking the actuator in either direction.



ATTENTION: RED PLASTIC PLUGS IN CONDUIT ENTRIES ARE FOR TRANSIT ONLY. FOR LONG TERM PROTECTION FIT SUITABLE METAL PLUGS.

ATTENZIONE: I TAPPI IN PLASTICA ROSSA PER L'ENTRATA CAVI SONO SOLO TEMPORANEI. PER UNA PROTEZIONE PERMANENTE PREGO SOSTITUIRLI CON APPOSITI TAPPI METALLICI.

ATENCION: LOS TAPONES ROJOS DE PLASTICO EN LAS ENTRADAS DE CABLE SON UNICAMENTE PARA TRANSPORTE. PARA PROTECCION PERMANENTE COLOCAR TAPONES METALICOS APROPIADOS.

ACHTUNG: DIE ROTEN PLASTIKSTOPFEN SIND NUR FÜR DEN TRANSPORT GEEIGNET. FÜR DAUERHAFTEN SCHUTZ SIND DIESE GEGEN GEEIGNETE BLINDSTOPFEN AUSZUTAUŠCHEN.

ATTENTION: LES BOUCHONS PLASTIQUES ASSURENT UNE PROTECTION TEMPORAIRE. POUR UNE PROTECTION DEFINITIVE UTILISER DES BOUCHONS METALLIQUES.

注意：コンジット口の赤色プラグは、輸送用を目的としたプラグです。長期に渡る保護の場合、適切なメタルプラグをご使用ください。

注意：接线端红色塑料封口仅为运输途中使用。长期正常保护时请用金属封口。

주의: 배선인입구의 빨간색 플라스틱 플러그는 오직 임시용입니다. 오래 보관하기 위해서는 규격에 맞는 금속 플러그를 사용하십시오.

7

Commissioning

7.1 The Setting Procedure

The Rotork SI actuators are designed so that commissioning may be carried out without removing any electrical covers.

Setting the internal hydraulic pressure, limit and other functions is achieved by using the Infrared Setting Tool. The Setting Tool is certified Intrinsically Safe to allow commissioning in hazardous areas.

All the commissioning functions are stored in non-volatile memory in the actuator. The Setting Tool enables the user to view all the functions in turn via the actuator display window. As each function is viewed its setting can be checked and, if required, changed within the bounds of that function.

The power supply must be connected and energised for commissioning purposes. The setting procedure is divided into two stages:

1. Basic Settings

Setting end of travel limit actions, pressure values and limit positions.

2. Configuration Settings

Settings covering the control, indication and optional equipment functions.

All SI actuator functions are configured before despatch to Rotork standard default settings unless alternatives have been specified with the order. Should difficulty be encountered during commissioning the default settings can be reinstated, returning the actuator configuration to its original manufactured state. Site commissioning can then begin again.

The default function should be used with caution as settings selected after manufacture may be essential for the safe operation of the valve and/or plant.

Actuator Display

Position Display

50

This may be an open or closed symbol or a percentage open value.

Pressure and Position

50

Refer to section 10.

Password

P?

PC

Bt

Pt

FT

Crossroad

cr

Basic Settings
Limit Actions
Pressure Values
Limit Positions

Configuration Settings
Indication Contacts
Control Mode
Options
Help Screens
Defaults





 **Note:** The Basic Settings must be commissioned first.

7.2 The Setting Tool (old version)



Specification

Enclosure	IP67
Certification	EEx ia IIC T4 (intrinsically safe) FM, INT SAFE, Class I & II Div 1 Groups A B C D E F G, T4A CSA, Exia, Class I, II Div 1 Groups A B C D
Power supply	9V Battery (supplied and fitted)
Operating range	0.75m (from actuator display window)

Name Instruction

1.  Key* Display next function down
2.  Key* Display next function across
3.  Key Decrease/change displayed function's value or option setting
4.  Key Increase/change displayed function's value or option setting
5.  Key Enter displayed value or option setting

Infrared local operation (when enabled)

6.  Key Non-functional on SI actuators
7.  Key Non-functional on SI actuators
8. Infrared Transmitter Window

* Pressing the two arrow keys together returns the actuator display to the position indication mode

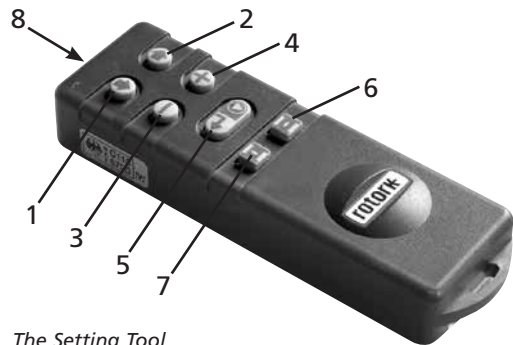









Fig. 7.1 The Setting Tool

7.3 The Setting Tool Pro

Name	Instruction
1.  Key*	Display next function down.
2.  Key	Display previous function up.
3.  Key*	Display next function across right.
4.  Key	Display previous function across left.
5. - Key	Decrease/change displayed function's value or option setting.
6. + Key	Increase/change displayed function's value or option setting.
7.  Key	Non-functional on SI actuators.
8.  Key	Enter displayed value or option setting.
9.	Infrared transmitter window.
10.  Key	Non-functional on SI actuators.
11.  Key	Non-functional on SI actuators.

* Pressing these two arrow keys together exits setting mode and returns the actuator display to the pressure/position indication mode.

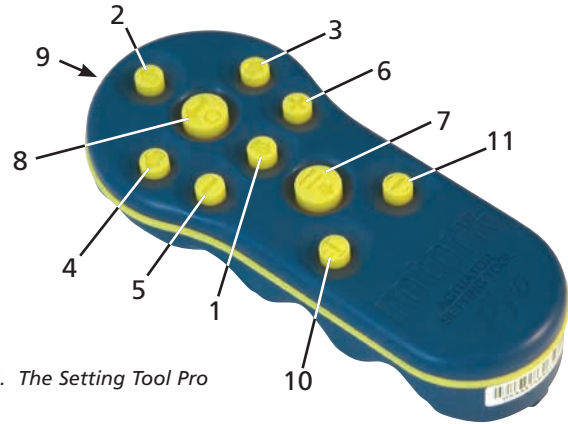









Fig. 7.3. The Setting Tool Pro

Specification

Enclosure:	IP54
Certification:	ATEX CE 0518 Ex II 1G FM, INT SAFE, Class I, Div 1, Groups A, B, C & D, T4. CSA, Exia, Class I, Div 1, Groups A, B, C & D, T4.
Temperature:	Tamb = -30 °C to 50 °C
Power supply:	2x 1.5V AA Batteries (supplied and fitted)
Operating range:	0.75m (from actuator display window)

7.4 The Rotork Bluetooth® Setting Tool

Name	Instruction
1.  Key*	Display next function down.
2.  Key	Display previous function up.
3.  Key*	Display next function across right.
4.  Key	Display previous function across left.
5. - Key	Decrease/change displayed function's value or option setting.
6. + Key	Increase/change displayed function's value or option setting.
7.  Key	Initiate download/upload via Bluetooth.
8.  Key	Enter displayed value or option setting.
9.	Infrared transmitter window.
10.  Key	Non-functional on SI actuators.
11.  Key	Non-functional on SI actuators.

* Pressing these two arrow keys together exits setting mode and returns the actuator display to the pressure/position indication mode.

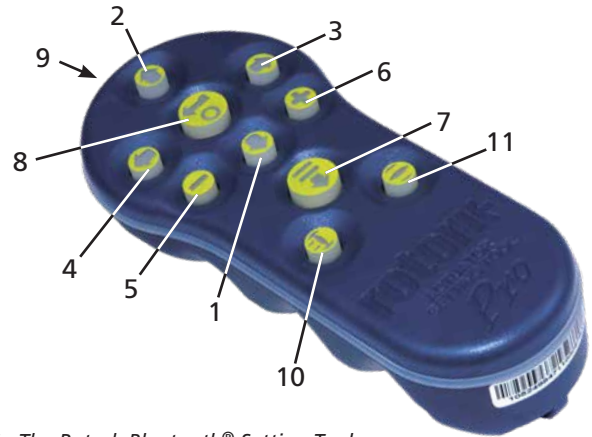

Fig. 7.4. The Rotork Bluetooth® Setting Tool

Specification

Enclosure: IP54
 Certification: ATEX CE 0518 Ex II 1G
 FM, INT SAFE, Class I, Div 1, Groups A, B, C & D, T4.
 CSA, Exia, Class I, Div 1, Groups A, B, C & D, T4.

Temperature: Tamb = -30 °C to 50 °C
 Power supply: 4 x 1.5V AAA Batteries (supplied and fitted)
 Operating range: Infrared: 0.75m (from actuator display window)
 Bluetooth: 3m (from actuator display window)

Setting Tool Battery Replacement

Battery status can be checked by looking at the Infrared transmitter window while depressing any Setting Tool button. A flashing red indicator should be seen.

⚠ Battery replacement must be carried out in a safe area. To replace the battery remove the six caphead screws in the back of the Setting Tool. Remove the back cover to expose the battery.

The Setting Tool (old version):

⚠ In order to maintain hazardous area certification fit only Duracell mN1604 or Rayovac Alkaline maximum NoAL-9V battery types.

The Setting Tool Pro:

⚠ In order to maintain hazardous area certification fit only with the following AA size, Alkaline-Manganese, approved battery types:

**Duracell, Coppertop, type MN1500
Duracell, Procell, type MN1500
GP, Super Alkaline, type GP15A**

Other types of AA size batteries, including Duracell, Ultra, type MN1500, must not be fitted.

The Bluetooth® Setting Tool:

⚠ In order to maintain hazardous area certification fit only with the following AAA size, Alkaline-Manganese or Zinc-Manganese approved battery types:

**Duracell, Procell, type MN2400
Energizer, type E92.**

Refit cover ensuring red indicator LED faces the transmitter window in the back cover.

When a button is depressed the Setting Tool transmits the relevant instruction to the actuator by infrared pulses and must therefore be directly in front of the actuator indicator window and at a distance no greater than 0.75m.

The enclosure of the actuator Setting Tool Pro, and Bluetooth® Setting Tool, is manufactured from the following materials:

Polycarbonate, ABS blend
Polycarbonate
Silicon Rubber

If the actuator Setting Tool Pro and Bluetooth® Setting Tool are likely to come into contact with aggressive substances (e.g. solvents that may affect polymetric materials), then it is the responsibility

of the user to take suitable precautions (e.g. regular checks as part of the routine inspections or establishing that the materials are resistant to the specific chemical) that prevent it from being adversely affected, thus ensuring that the type of protection is not too compromised.

No form of repair must be attempted on any of the actuator Setting Tools.

Download / Upload Function

This new feature has been introduced with the new Rotork Bluetooth® Setting Tool. It allows the user to download datalogger files and download/upload configuration files. The new tool is weatherproof and intrinsically safe and so it can be used safely in all environments. *Refer to Bluetooth® Setting Tool publication PUB095-001.*

Display Set-Up Mode

The Setting Tool and Setting Tool arrow keys are used to access and navigate through the actuator set-up procedure using the actuator display. Each actuator function with its current setting is represented on screen by a combination of code and text.

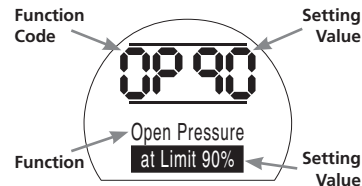

The Setting Tool change keys (+ and -) allow the user to view the available setting options.

The examples of displayed functions **Close Action, [C2]** and **Open Pressure, [OP]** are shown to the right. Note that a setting option or value is highlighted.

This instruction manual uses both code and text for description.

7.5 Entering the Actuator Setting Procedure

With the actuator securely mounted on the valve, the mains supply on and Local control or Stop selected.

PRESS THE ↓ KEY.

The actuator upper display will remain the same and the lower display will change to Pressure value. This will be represented by Pressure = XX%,XXBAR or XXPSI and a bar graph.

PRESS THE ↓ KEY.

The actuator display will change and the password protection display will be seen.



The Actuator Function Settings can be protected by the Use of a Password

7.6 Setting Mode – Password

To enable setting and adjustment of the actuator functions the correct password must be entered. The factory set (default) password is [1d]. If the actuator has previously been set with a site password this must be entered.

Use the + or – keys to scroll through the available passwords 00–FF (hexadecimal). With the correct password displayed press the enter key.

PRESS THE ↵ KEY.

Two “setting” bars will appear and will remain visible on every function display screen. In addition, “Password Correct” will be displayed for 3 seconds.



Default Password, Setting Mode Enabled

7.7 New Password [PC]

To configure a new password, the actuator must be in setting mode with the password display – setting mode enabled – showing,

PRESS THE → KEY.

The display will change to [PC].

Using the + or – key scroll through the available passwords until the desired password is displayed.

PRESS THE ↵ KEY.



Password Changed to [1E]

NOTE: The new password becomes effective the next time setting mode is entered.

7.8 Checking Mode

The actuator function settings can be checked without entering the correct password. The settings can only be viewed and not altered. The setting bars will not be seen.



Password Display, Checking Mode

Once the procedure has been completed in the required mode

PRESS THE ↓ KEY.

The procedure branch [Cr] (crossroad) display can now be seen.

7.9 Bluetooth Diagnostic and Configuration

SI Pro actuators include a Bluetooth interface as standard, allowing non-intrusive diagnostics, analysis and configuration.

Insight II software for PC has been developed to enable the actuator configuration and onboard Datalogger to be reconfigured and analysed. A PC running Insight II software can be used to interrogate the actuator via non-intrusive Bluetooth communication. Visit www.rotork.com for information.

Alternatively, the intrinsically safe Rotork Bluetooth® Setting Tool allows the user to extract and store SI actuator configuration and Datalogger files within the tool. Stored files can then be uploaded via Bluetooth to a PC running Insight II where they can be viewed, analysed and stored in a safe, clean environment.

Using the Bluetooth® Setting Tool, actuator setup can be configured on the PC, stored in the tool, transported to the actuator and uploaded. The tool can transfer the same configuration to multiple actuators where actuator setup is the same.

Refer to PUB095-001-00 for full instructions on the use of the Rotork Bluetooth® Setting Tool.

To enable communication with Insight II, the actuators Bluetooth interface must be enabled.

The default setting for the Bluetooth interface is **[OF]** disabling Bluetooth.

[OF] Off (Default): Bluetooth is disabled

[ON] On: Bluetooth is permanently enabled.

[LS] Local Stop Only: Bluetooth is only enabled when the actuator is in Local Stop.

To change this setting press the + or – key until the required setting is displayed.



PRESS THE ← KEY.

The displayed option will flash (stored) indicating that it has been set.

7.10 Partial Stroke Test

This function performs a partial stroke test based on the parameters set in **[PP]** and a setup test being completed in **[SP]**. Insight II can then be used to compare subsequent partial stroke tests against the original test when the actuator was first commissioned.

The actuator must be in Local to perform a test.

The actuator needs to be moved to the correct limit prior to initiating the test

[Pt] Perform the partial stroke test.



PRESS THE ← KEY.

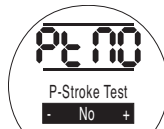

This brings up an option to either cancel or confirm that the partial stroke test should be completed.

To cancel the test: Ensure that **[No]** is displayed on the screen.

PRESS THE ← KEY.

To confirm that the test should be completed: Press the + key until the display changes to **[Ys]**



PRESS THE ← KEY.

7.11 Full Stroke Test

This function performs a full stroke test based on a setup test being completed in [SF]. Insight II can then be used to compare subsequent full stroke tests against the original test when the actuator was first commissioned.

The actuator must be in Local to perform a test.

The actuator needs to be moved to either the closed or open limit prior to initiating the test.

[Ft] Perform the partial stroke test.



PRESS THE  KEY.



This brings up an option to either cancel or confirm that the full stroke test should be completed.

To cancel the test: Ensure that [No] is displayed on the screen.

PRESS THE  KEY.

To confirm that the test should be completed: Press the + key until the display changes to [yS]



PRESS THE  KEY.

7.12 Crossroad [Cr]

To access the Basic Settings **press the arrow ↓ key**. Refer to 8.

To access the Configuration Settings **press the arrow → key**. Refer to section 9.

7.13 The Actuator Display – Setting/Checking Mode

Actuator functions as laid out in the Basic and Configuration commissioning stages, can be individually displayed by using the Setting Tool arrow keys.

The ↓ arrow key will always display the FIRST function on the next level DOWN within the procedure.

The → arrow key will always display the NEXT function on the SAME level and will wrap around the functions on the same level.

Actuator functions are displayed in code form in the top left portion of the liquid crystal display screen.

The setting for the displayed function is shown in the top right hand portion of the screen. Depending on the actuator function displayed, its setting may be an option or a value.

Text relating to the function and setting values will be displayed in the lower display.

In setting mode the Setting Tool + or – keys will cause the setting to be changed. In checking mode the settings cannot be altered.

In setting mode, once displayed, a new setting can be entered into the actuator memory by pressing the  key. The setting will flash off and back on, confirming its selection, and "Stored" will be displayed for 2 seconds in the text display.

TOP LEFT PORTION

Function e.g.
OP = Open Pressure



TOP RIGHT PORTION

Function Setting
e.g. Value = 90%

Open Pressure
at Limit 90%

LOWER DISPLAY

Function: Open Pressure
Setting Value: 90%

7.14 Returning to Valve Position Display

There are five ways of returning to valve position display:





1. Approximately 5 minutes after the last Setting Tool operation the display will automatically return to position display.
2. Press the  and  arrow keys together.
3. Press the  arrow key until the display returns to position.
4. Press the  arrow key to return to position display.
5. Select Remote control using the red Local/Stop/Remote selector.



Fig. 8

ELECTRICAL OPERATION MUST NOT TAKE PLACE UNTIL THE BASIC SETTINGS HAVE BEEN MADE AND CHECKED.

The actuator's Basic Settings affect the correct operation of the valve by the actuator. If the actuator has been supplied with the valve, the valve maker or supplier may have already made these settings.

This instruction assumes setting mode has been entered. Refer to section 7.6.

Viewing the Basic Settings

With the actuator mounted on the valve, the power supply on and Local or Stop control selected, point the Setting Tool at the actuator indicator window from a distance of no more than 0.75m. By pressing the ↓ key and, when appropriate, the → key, it is possible to move through the procedure, displaying the various functions and their settings as shown in figure 8.1. The right-hand side of figure 8.1 explains the function of each LCD display.

⚠ Settings and operation must be verified by electric operation and function test of the actuator to ensure correct operation.

Viewing the Basic Settings

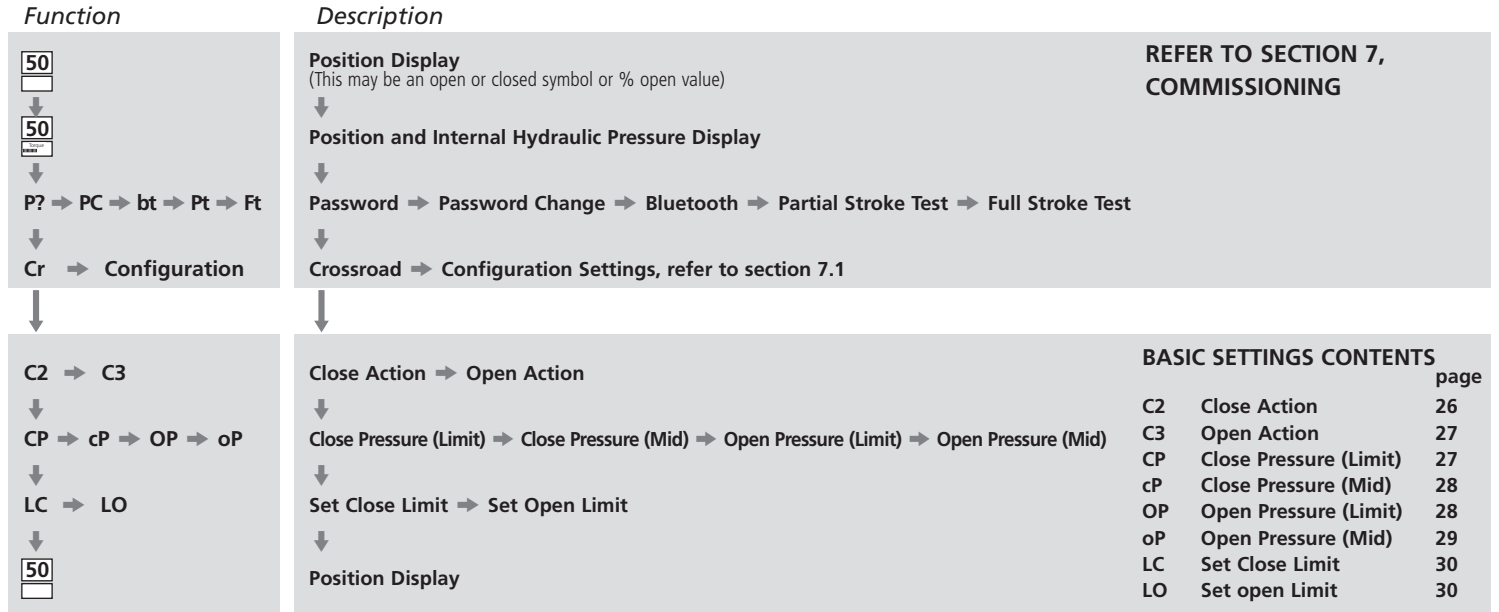

Fig. 8.1 Basic Setting Displays

Each actuator is built in the factory to be either Normally Closed, or Normally Open or Stay-put depending on what configuration was ordered.

Normally Closed:

Quarter-turn
(spring-return clockwise)

Linear
(spring-return to extend)

Normally Open:

Quarter-turn
(spring-return anti-clockwise)

Linear
(spring-return to retract)

Consult factory if this configuration needs to be changed as it cannot be done through software alone.

The actuator can be configured to either close on Pressure (hydraulic or spring) for seating valves or Limit for non-seating valves.

⚠ Refer to valve manufacturer for recommended setting.

50



50



P? → PC → bt → Pt → Ft



Cr



C2 → C3



CP → cP → OP → oP



LC → LO



50



[CP] Stop on Pressure (Default)

[CL] Stop on Limit

To change the function press the + or – key until the required setting is displayed.

PRESS THE  KEY.

The displayed option will flash (stored), indicating that it has been set.

C3**Open Action**

The actuator can be configured to either open on Pressure (hydraulic or spring) for back seating valves or Limit for non-back seating valves.

⚠ Refer to valve manufacturer for recommended setting.



[OL] Stop on Limit (Default)

[OP] Stop on Pressure

To change the function press the + or - key until the required setting is displayed.

PRESS THE ← KEY.

The displayed option will flash (stored), indicating that it has been set.

50

50

P? → PC → bt → Pt → Ft

Cr

C2 → **C3**

CP → cP → OP → oP

LC → LO

50

CP**Close Pressure at Limit**

This setting allows the maximum cut-off pressure in a normally open actuator while travelling from the closed electrical limit to the closed mechanical end stop to be set. The value set is a % of the maximum available pressure, which is limited by the pressure relief valve.



To change this value press the + or - key until the required setting is displayed.

PRESS THE ← KEY.

The displayed option will flash (stored), indicating that it has been set.

50

50

P? → PC → bt → Pt → Ft

Cr

C2 → C3

CP → cP → OP → oP

LC → LO

50

cP

Close Pressure at Mid

This setting allows the maximum cut-off pressure in a normally open actuator while travelling in mid-travel between the open and closed electrical limits while closing to be set. If the value is set to 00, the pressure-off value from CP is used.



To change the function press the + or - key until the required setting is displayed.

PRESS THE ← KEY.

The displayed option will flash (stored), indicating that it has been set.

50



50



P? → PC → bt → Pt → Ft



Cr



C2 → C3



CP → cP → OP → oP



LC → LO



50



OP

Open Pressure at Limit

This setting allows the maximum cut-off pressure in a normally closed actuator while travelling from the open electrical limit to the open mechanical end stop to be set. The value set is a % of the maximum available pressure, which is limited by the pressure relief valve.



To change the function press the + or - key until the required setting is displayed.

PRESS THE ← KEY.

The displayed option will flash (stored), indicating that it has been set.

50



50



P? → PC → bt → Pt → Ft



Cr



C2 → C3



CP → cP → OP → oP



LC → LO



50



oP

Open Pressure at Mid

This setting allows the maximum cut-off pressure in a normally closed actuator while in mid-travel between the closed and open electrical limits while opening to be set. If the value is set to 00, the pressure-off value from OP is used.



To change the function press the + or - key until the required setting is displayed.

PRESS THE  KEY.

The displayed option will flash (stored), indicating that it has been set.

⚠ If the actuator fails to complete a closed or open valve operation due to the set pressure being reached, it may indicate a valve and/or process problem or change. It is the responsibility of the user to ensure the valve and process conditions are within the specified operational limits before increasing the pressure value.

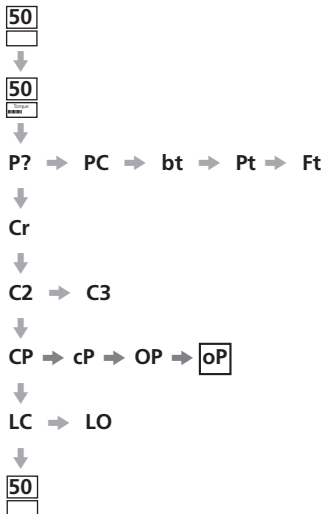

Setting the Closed / Open Limit

To set the closed and open electrical limits correctly, the actuator should be moved to both the closed and open mechanical limits and the positions stored. The actuator will then automatically scale in 2% from each end to set the electrical limits.

The number shown in the top right of the display screen when in either LC or LO, is the percentage of full scale read directly back from the positional feedback device.

When at either the closed or open limit, if the number on the screen is between 00 - 05 or 95 - 99, the actuator will indicate a PO fault and will not operate, it assumes that there is a problem with feedback device. If this is the case then the feedback device will require adjustment.

LC

Set Closed Limit

Move the actuator to the closed position by using the local controls.

50

50

50

50

P? → PC → bt → Pt → Ft

Cr

C2 → C3

CP → cP → OP → oP

LC → LO

50

50



To change the function press the + or - key until the required setting is displayed.

PRESS THE  KEY.

The displayed option will flash (stored), indicating that it has been set.

LO

Set Open Limit

Move the actuator to the open position by using the local controls.

50

50

50

50

P? → PC → bt → Pt → Ft

Cr

C2 → C3

CP → cP → OP → oP

LC → LO

50

50



To change the function press the + or - key until the required setting is displayed.

PRESS THE  KEY.

The displayed option will flash (stored), indicating that it has been set.

8.1 Menu Structure

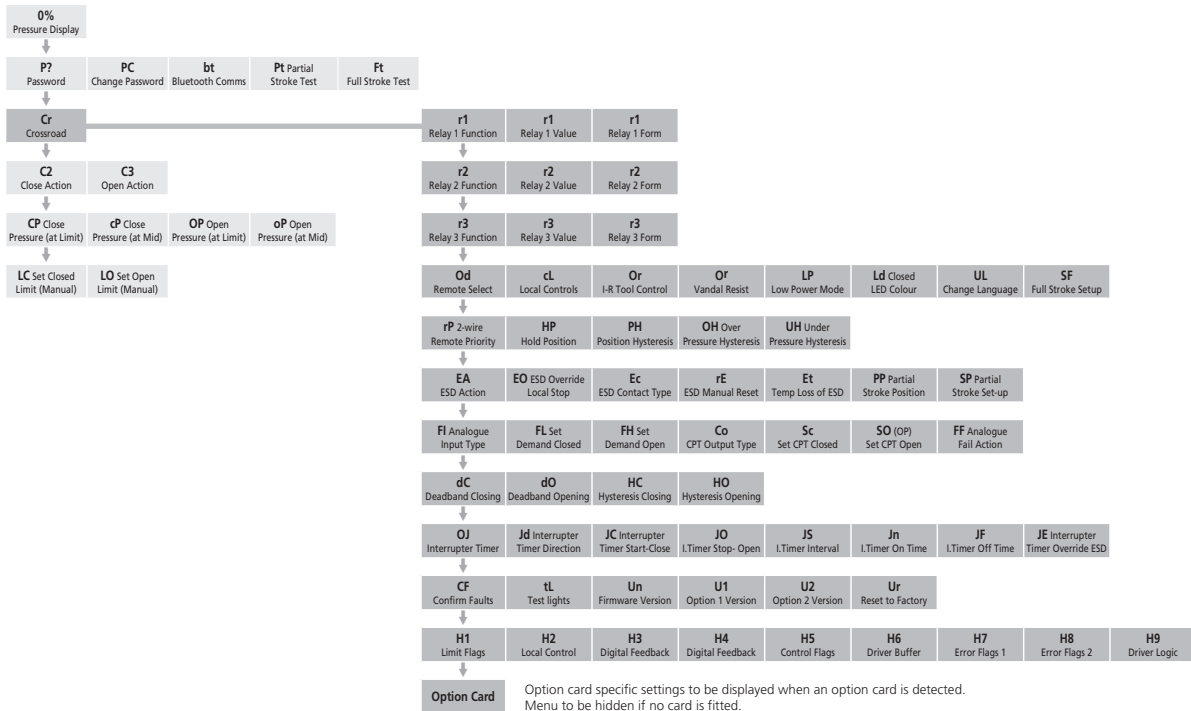

- Contract r1
- Contract r2
- Contract r3
- General Settings
- Digital Control
- ESD/Partial Stroke
- Analogue Control 1
- Analogue Control 2
- Interrupter Timer
- Service Mode
- Help Screens
- Option Card

CONFIGURATION SETTINGS

9.1	Accessing Configuration Settings	32
9.2	Indication Contacts r1, r2 and r3	33
9.3	General Settings	34
9.4	Digital Control	37
9.5	ESD / Partial Stroke Settings	38
9.6	Analogue Control 1	42
9.7	Analogue Control 2	44
9.8	Interrupter Timer	46
9.9	Service	49
9.10	Bus System Option Pakscan	51
9.11	Bus System Option Modbus	54
9.12	Bus System Option Profibus DP	57
9.13	Bus System Option DeviceNet	60
9.14	Bus System Positioning Control Settings	63

Having established that the Basic Settings have been correctly set, the Configuration Settings can now be configured to suit the site control and indication requirements.

It is possible to move through the various Configuration Settings as shown in figure 9.2 using the → and ↓ keys.

The actuator model code will indicate any options fitted.

In order to display the Configuration Settings it is necessary to press the ↓ key until [Cr] appears.

If you have chosen to enter Configuration Settings in the checking mode the display will be as figure 9.2.

If you have chosen to enter Configuration Settings in the setting mode the display will be as figure 9.3
Refer to section 7.



Fig. 9.2



Fig. 9.3

PRESS THE → KEY.

9.2 Indication Contacts r1, r2 and r3

Indication contacts r1, r2 and r3 may each be set to trip for any one of the following functions:

Code	Function (as displayed)
[CL]	Closed Limit
[OP]	Open Limit
[FA]	Fault Alarm
[Po]	Position % Open
[rr]	Motor Running
[dC]	Closing
[dO]	Opening
[rn]	Moving
[St]	Stall (mid-travel)
[SE]	Stall (end of travel)
[SP]	Stall (any position)
[Pt]	Over pressure (mid-travel)
[PE]	Over pressure (end of travel)
[PP]	Over pressure (any position)
[LS]	Stop Selected
[Lo]	Local Selected
[rE]	Remote Selected
[CA]	Control Alarm
[ES]	ESD Active
[tt]	Temperature (°C)

[HA]	Manual override switch
[AS]	Accumulator pressure switch
[Er]	External manual reset switch
[Ht]	Motor thermostat switch
[PP]	Partial stroke passed
[PF]	Partial stroke failed
[n2]	Monitor 2
[OF]	Off

The r contact form can be set normally open [nO] or normally closed [nC].

The procedures for setting up contacts r2 and r3 are the same as those shown for r1.

Unless specified with order, the default settings for indication contacts are as follows:

r1 – [OP] Open Limit [nO]

r2 – [CL] Closed Limit [nO]

r3 – [FA] Fault Alarm [nO]

r1 Relay 1 Function

To change the function press the + or – key until the required setting is displayed.

PRESS THE  KEY.

The displayed function will flash indicating that it has been set.



r1 Relay 1 Value

This screen will only be displayed if the relay function is set to [Po] Position % Open and [tt] Temperature (°C).

When the relay function is set to either [Po] or [tt], the required trip value must be set.

The value can be set from 1% to 99% in 1% increments for [Po] or 60 °C to 99 °C in 1 °C increments for [tt].

To change the value press the + or – key until the required setting is displayed.

PRESS THE  KEY.

The displayed value will flash (stored) indicating that it has been set.



r1

Relay 1 Form

If function **[Po]** Position % Open, is selected and it is configured as a normally open contact it will make at the set value with the actuator moving in the open direction.

To change the form press the **+** or **-** key until the required setting is displayed.

[nO] Normally Open (Default):

[nC] Normally Closed:

PRESS THE  KEY.

The displayed option will flash (stored) indicating that it has been set.



To access r2 and r3

PRESS THE  KEY.

9.3

General Settings

This section includes selecting the remote control source for the actuator along with configuring the local controls, changing the colour of the closed LED, changing the display language and performing a full stroke reference test.

Od

Remote Select

The correct setting for remote control source will be determined by the type of remote control required and the option specified and fitted, if any.

There are five options available to configure the remote control source:

[RE] Digital (Default): Select this option for hard-wired pushbutton / relay contact control.

[AI] Analogue: Select this option if the actuator is remotely controlled by an external analogue signal in the range 0-20 mA or 0-10 Volts, with or without offset zero.

[OP] Option: Select this option if the actuator is fitted with one of the following Network cards:

Pakscan

Modbus

Profibus

Foundation Fieldbus

DeviceNet

[OE] Option ESD: Select this option if the actuator is fitted with one of the Network cards listed above and a hardwired ESD override facility is also required.

[OF] Off: Select this option to disable control from a remote source. The actuator will operate from the local controls only.

To change the configuration press the **+** or **-** key until the required setting is displayed.

PRESS THE  KEY.

The displayed option will flash (stored) indicating that it has been set.



cL Local Control

There are two options available to configure the operation of the local controls:

[Pr] Push to Run (Default): Select this option if the actuator is required to stop when the black knob is released.

[nn] Maintain: Select this option if the actuator is required to run to either the open or closed limit when the black knob is released.

To change the configuration press the **+** or **-** key until the required setting is displayed.

PRESS THE  KEY.

The displayed option will flash (stored) indicating that it has been set.



Or I-R Tool Control

This feature allows the user to open and close the actuator using the setting tool.



[OF] Control Disabled (Default)

[On] Enabled: Allows the setting tool to control the actuator, moving open and closing using the buttons on the setting tool. The actuator must be set to local and can only be operated when in this **Or** screen.

To change the preference press the **+** or **-** key until the required setting is displayed.

PRESS THE  KEY.

Setting tool commands are as follows:

-  - Opens the actuator
-  - Closes the actuator
-  - Stops the actuator



When the local controls are removed this screen will be replaced by **Or**

Or Vandal Resist

This option is only visible when the local controls have been removed.

[rE] Remote Only (Default): Actuator can be controlled via remote inputs only the setting tool is disabled.

[On] Local Only: Actuator can be operated using the Setting Tool when in the Or menu in the hidden menus.

[OF] Control Disabled: Actuator control is disabled.

To change the preference press the **+** or **-** key until the required setting is displayed.

PRESS THE  KEY.



LP Low Power Mode

It is possible to use an external power supply such as a solar power system for 24 VDC actuators. If this is the case then it is beneficial to limit power consumption while the actuator is at rest.

There are three options available to configure the power consumption:

[OF] Off (Default): Select this option to turn the display backlight on permanently.

[On] On: Select this option to automatically switch the display backlight off. This will be done 5 minutes after the actuator was last used with either the setting tool or local controls.

[EL] Extra: Select this option to further reduce the power consumption by inverting the monitor relay and disabling the CPT output.

To change the configuration press the **+** or **-** key until the required setting is displayed.

PRESS THE  KEY.

The displayed option will flash (stored) indicating that it has been set.

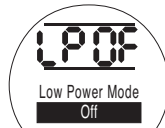

Ld Closed LED Colour

There are two options available:

[gr] Green (Default): Select this option for the LED to be green at the closed limit and red at the open limit.

[RE] Red: Select this option for the LED to be red at the closed limit and green at the open limit.

To change the configuration press the + or - key until the required setting is displayed.

PRESS THE  KEY.

The displayed option will flash (stored) indicating that it has been set.



UL Language

The default display text language is English. Consult the factory for which additional display text languages are available.

To change the language press the + or - key until the required setting is displayed.

PRESS THE  KEY.

The displayed option will flash (stored) indicating that it has been set.



SF Full Stroke Setup (Reference Test)

This function performs a full cycle of the actuator and records the position and internal hydraulic pressure against time in both the open and closed directions. This should be carried out once the actuator has been commissioned on site. Using Insight II it can then be compared against subsequent tests carried out at a later date.

The actuator needs to be positioned at a limit to perform this test.

[SF] Perform the full stroke reference test.



PRESS THE  KEY.



This brings up an option to either cancel or confirm that the reference partial stroke test should be completed.

To cancel the test: Ensure that **[No]** is displayed on the screen

PRESS THE  KEY.

To confirm that the test should be completed: Press the + key until the display changes to **[yS]**.



PRESS THE  KEY.

This section includes selecting the action for 2-wire priority and settings related to how the actuator should hold its current position.

The default setting for 2-wire remote priority is **[SP] Stay Put**. If open and closed hard-wired signals are applied simultaneously the actuator will stay put (stop if running).

[SP] Stay (Default)

[CL] Close

[OP] Open

To change the priority press the + or – key until the required setting is displayed.

PRESS THE ← KEY.

The displayed option will flash (stored) indicating that it has been set.



The default setting is to maintain the current position (across the full stroke), until another command to move is given. This feature will compensate for any drift in position, in either direction by operating either the pump or solenoid valve(s).

[On] On (Default): This option will maintain the current position of the actuator

[Off] Off: This option will allow the position of the actuator to drift.

To change this preference press the + or – key until the required setting is displayed.



PRESS THE ← KEY.

The displayed option will flash (stored) indicating that it has been set.

This feature works in conjunction with **[HP] Hold Position** and sets the amount of movement that is permitted before the actuator should automatically reposition itself.

The default value is 0.5% **[05]**.

The minimum settable value is 0.1% and the maximum settable value is 9.9%.

To change this value press the + or – keys to increase or decrease the set value.

When the desired value is on the display

PRESS THE ↓ KEY

The displayed value will flash indicating that it has been set.



OH Over Pressure Hysteresis

This feature will vent the internal hydraulic pressure in the actuator if it reaches a set defined value while the actuator is at position limit, for example due to thermal expansion.

The default value is 10% above the value set in **[CP] Close Pressure (Limit)** and **[OP] Open Pressure (Limit)**.

The minimum settable value is 1% and the maximum settable value is 99%.

To change this value press the **+** or **-** keys to increase or decrease the set value.

PRESS THE **↓** KEY

The displayed value will flash indicating that it has been set.



UH Under Pressure Hysteresis

This feature will increase the internal hydraulic pressure in the actuator if it falls to a set defined value while the actuator is at position limit, for example due to thermal contraction.

The default value is 10% below the value set in **[CP] Close Pressure (Limit)** and **[OP] Open Pressure (Limit)**.

The minimum settable value is 1% and the maximum settable value is 99%.

To change this value press the **+** or **-** keys to increase or decrease the set value.

PRESS THE **↓** KEY

The displayed value will flash indicating that it has been set.



9.5 ESD / Partial Stroke Settings

The SI actuators have two separate ESD circuits, a software driven circuit and hardware driven circuit.

The software ESD function has three settings in this menu that can be adjusted **[EA] Software ESD Action**, **[EO] ESD Local Stop Override** and **[EC] ESD Contact Type**.

The hardware ESD circuit does not rely on the software to initiate an active ESD signal (although the software does monitor the ESD line).

For normal operation, there must be an ESD signal present on the actuator. Once the ESD signal is removed all power to the solenoid valves will also be removed instantaneously regardless of any other command or setting.

There is a physical link on the Power PCB, which is used to switch between the two. By default the actuator will be supplied set for software ESD control unless ordered for hardware ESD. Consult the factory for changing this link.

EA ESD Action (Software)

An active ESD signal applied to the actuator will override any existing or applied local or remote control signal.

Press the **+** or **-** key to select the required ESD action:

[E] De-Energise (Default): This option will de-energise all the solenoid valves.

[C] Close: This option will perform a Close command.

[O] Open: This option will perform a Open command.

[IP] Stay Put: This option will perform a Stop command.

To change the ESD action press the **+** or **-** key until the required setting is displayed.

PRESS THE **←** KEY.

The displayed option will flash (stored) indicating that it has been set.



EO ESD Override Local Stop

The feature allows you to choose if an active ESD signal should override Local Stop.

[OF] No (Default): Select this option if a software ESD command should NOT override Local Stop.

[On] Yes: Select this option if a software ESD command should override Local Stop.

To change the setting press the + or – key until the required setting is displayed.

PRESS THE  KEY.

The displayed option will flash (stored) indicating that it has been set.



Ec ESD Contact Type

This setting determines if a signal should be applied, or removed to initiate the software ESD action.

[nO] Normally Open (Default): The ESD signal has to be applied to perform software ESD function.

[nC] Normally Closed: The ESD signal has to be removed to perform software ESD function.

To change the ESD Contact press the + or – key until the required setting is displayed.

PRESS THE  KEY.

The displayed option will flash (stored) indicating that it has been set.



rE ESD Manual Reset

This feature allows the actuator to be disabled from operational commands after an ESD event until it has been manually reset. To perform a manual reset the red local controls knob has to be moved to Stop and then to either Local or Remote. Once this is done the actuator can be commanded to move again.

This works in both Hardware and Software ESD.

[OF] No Reset (Default): Select this option if the actuator does not need to be reset after a ESD event or loss of mains power.

[Ed] After ESD: Select this option if the actuator must be manually reset after an ESD event.

[LP] After Mains Loss: Select this option if the actuator must be manually reset after loss of mains power.

[On] ESD/Mains Loss: Select this option if the actuator must be manually reset after an ESD event or loss of mains power

To change the Manual Reset option press the + or – key until the required setting is displayed.

PRESS THE  KEY.

The displayed option will flash (stored) indicating that it has been set.

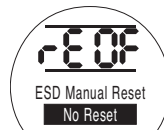

Et**Temporary Loss of ESD Signal**

This feature determines what action should be taken if the ESD signal is lost temporarily (for a time period less than that needed for the ESD action to be completed).

This works in both Hardware and Software ESD.

[Sr] Stop - Return (Default): This option will stop the actuator once the ESD signal is inactive and the actuator will then operate again if a command to move is present.

[Sn] Stop - Wait: This option will stop the actuator once the ESD signal is inactive and the actuator will wait until a new command is given.

[Ct] Continue ESD: This option will allow the actuator to continue with the ESD function once the ESD signal is inactive.

These settings will work in conjunction with the ESD Manual Reset **[rE]** option.

To change the action to be carried out press the **+** or **-** key until the required setting is displayed.

PRESS THE  KEY.

The displayed option will flash (stored) indicating that it has been set.

**PP****Partial Stroke Position**

This sets the position that the actuator should move to when commanded to perform a partial stroke test.

The default value is 90% open.

The minimum settable value is 1% and the maximum settable value is 99%.

The partial stroke command will use the analogue input deadband **[dC]** & **[dO]** and hysteresis values **[HC]** & **[HO]** to position the actuator correctly.

To change this value press the **+** or **-** key until the required setting is displayed.

PRESS THE  KEY.

The displayed option will flash (stored) indicating that it has been set.

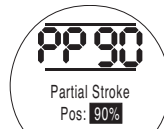

SP

Partial Stroke Setup (Reference Test)

This function performs a partial stroke of the actuator and records the position and internal hydraulic pressure against time in both the open and closed directions. This should be carried out once the actuator has been commissioned on site. Using Insight II it can then be compared against subsequent tests carried out at a later date.

The actuator needs to be moved to the limit that the partial stroke test should be started from prior to initiating the test.

[SP] Perform the reference partial stroke test.



PRESS THE  KEY.



This brings up an option to either cancel or confirm that the reference partial stroke test should be completed.

To cancel the test: Ensure that **[No]** is displayed on the screen

PRESS THE  KEY.

To confirm that the test should be completed: Press the + key until the display changes to **[Yes]**



PRESS THE  KEY.

This section describes how to select the correct analogue signal type (current or voltage) and then how to calibrate the desired demand input signal values to each limit along with the CPT (current position transmitter).

The analogue input signal can either be set as current (0-20 mA) or voltage (0-10 VDC).

[CU] Current (Default): This option will allow the actuator to be controlled by a varying current signal.

[UO] Voltage (Default): This option will allow the actuator to be controlled by a varying voltage signal.

To change this value press the + or - key until the required setting is displayed.

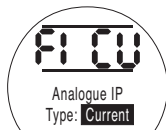

PRESS THE ← KEY.

The displayed option will flash (stored) indicating that it has been set.

Apply the analogue Close demand current or voltage signal corresponding to the Close position to calibrate this setting.

In the example below **[08]** = 8% of full scale Demand. Any value can be set, either high or low.

PRESS THE ← KEY.

The displayed option will flash (stored) indicating that it has been set.



Apply the analogue Open demand current or voltage signal corresponding to the Open position to calibrate this setting.

In the example below **[43]** = 43% of full scale Demand. Any value can be set, either high or low.

PRESS THE ← KEY.

The displayed option will flash (stored) indicating that it has been set.



Co**Set CPT Output**

The CPT output can be set to either represent the position or internal hydraulic pressure as a current (4 - 20 mA) output.

To change the type of output press the + or – key until the required setting is displayed

[Po] Position (Default): The CPT will output the actuators current position.

[Pr] Pressure: The CPT will output the actuators current internal hydraulic pressure.



PRESS THE  KEY.

The displayed option will flash (stored) indicating that it has been set.

Sc**CPT – Set Closed**

To calibrate the CPT output for the closed limit position, connect a current measuring device to the CPT terminals.

Press the + or – keys until the required output is shown on the measuring device.

PRESS THE  KEY.

The displayed option will flash (stored) indicating that it has been set.

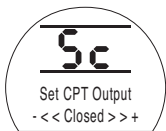
**SO****CPT – Set Open**

To calibrate the CPT output for the open limit position, connect a current measuring device to the CPT terminals.

Press the + or – keys until the required output is shown on the measuring device.

PRESS THE  KEY.

The displayed option will flash (stored) indicating that it has been set.

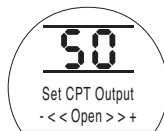

FF Analogue Signal Failure Action

This sets the action to be taken upon loss of the analogue signal. The set action will be taken once the demand signal falls below half the minimum value calibrated. For example, action will be taken if the signal falls below 2 mA if the lowest calibrated value is 4 mA.

[OF] Alarm Off (Default): This option will move the actuator to the low demand signal position.

[A] Alarm On: This option will trip the fault relay and move the actuator to the low demand signal position.

[AE] Alarm and SW ESD: This option will trip the fault relay plus the actuator will carry out the Software ESD action.

To change this function press the + or - key until the required setting is displayed.



PRESS THE  KEY.

The displayed option will flash (stored) indicating that it has been set.

9.7 Analogue Control 2

Selectable Deadband and Hysteresis values (independent in both directions to optimise for different operating speeds), are used to compensate for momentum and solenoid valve response time. Proper calibration provides accurate positioning; preventing the actuator from "hunting" and reducing the number of motor/pump starts.

Some understanding of the operational design parameters is required to optimally set Deadband and Hysteresis.

If the actuator was at the closed limit and a demand position input of 50% was received, then, the controller will command it to move in the open direction until it reaches 49.7% (Demand - (Deadband-Hysteresis)).

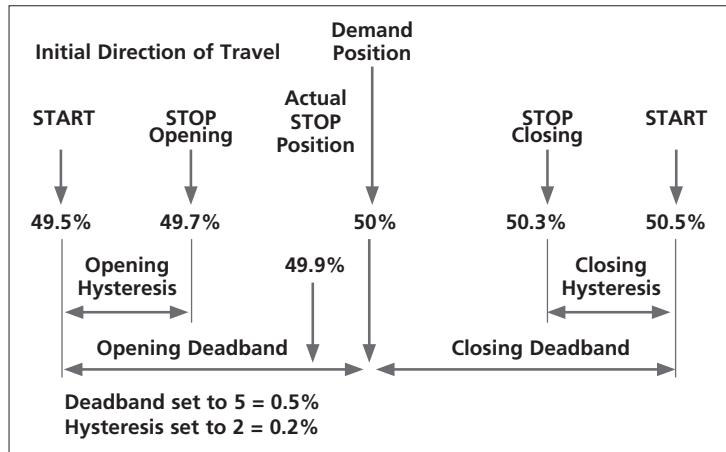

Momentum/Solenoid response times within the system may cause the actuator to continue moving after the stop command has been issued as shown by the "Actual Stopped Position" at 49.9%.

Movement will not be commanded again until the measured position falls outside of the Deadband either side of the demand position. If the Deadband was smaller, it would be possible for the actual stopped position to have fallen the other side of the Deadband and as such the actuator would be commanded to move in the opposite direction in order to meet the demand. This would result in "hunting" as the actuator oscillated around the Demand point.

By increasing the Deadband but also increasing the amount of hysteresis, the actual demand position can be met without "hunting" occurring.

dC Analogue Input – Close Deadband

The closing Deadband value is displayed as a % of full stroke. The default value is 1%.

The minimum settable value is 0.1% and the maximum settable value is 9.9% in 0.1% increments.

To change this value press the + or – key until the required setting is displayed.

PRESS THE  KEY.

The displayed option will flash (stored) indicating that it has been set.

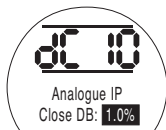

dO Analogue Input – Open Deadband

The opening Deadband value is displayed as a % of full stroke. The default value is 1%.

The minimum settable value is 0.1% and the maximum settable value is 9.9% in 0.1% increments.

To change this value press the + or – key until the required setting is displayed.

PRESS THE  KEY.

The displayed option will flash (stored) indicating that it has been set.

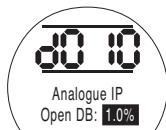

HC Hysteresis Closing

The closing hysteresis value is displayed as a % of full stroke. The default value is 0.5%.

The minimum settable value is 0.1% and the maximum settable value is 9.9% in 0.1% increments.

To change this value press the + or – key until the required setting is displayed.

PRESS THE  KEY.

The displayed option will flash (stored) indicating that it has been set.

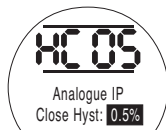

HO Hysteresis Opening

The opening hysteresis value is displayed as a % of full stroke. The default value is 0.5%.

The minimum settable value is 0.1% and the maximum settable value is 9.9% in 0.1% increments.

To change this value press the + or – key until the required setting is displayed.

PRESS THE  KEY.

The displayed option will flash (stored) indicating that it has been set.

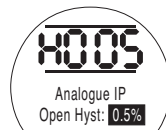

9.8 Option Interrupter Timer

The interrupter timer enables pulsed “stop/start” operation by the actuator as a response to local and remote control commands.

This effectively increases the valve stroke time and can be adjusted to prevent hydraulic shock (water hammer) and flow surges in pipelines.

When enabled, the interrupter timer operates in both local and remote control.

OJ Interrupter Timer Enabled/Disabled

To enable the Interrupter Timer press the + or - keys to toggle between [OF] and [On]

PRESS THE  KEY.

The displayed option will flash (stored) indicating that it has been set.



When the timer option is enabled an additional series of settings can be accessed by pressing the  key.

NOTE: If the timer option is not available pressing the  key will not access setting.

Press the  key to display interrupter timer set-up screens.

Jd Interrupter Timer Direction

The default for timer direction is [CL], timer operation will **start in closing** and **stop in opening** – pulsing operation around the close position.

If pulsing operation is required to stop in closing and start in opening – around the open position, use the + or - key.

The display will change to [OP] Opening.

PRESS THE  KEY.

The displayed option will flash (stored) indicating that it has been set.



NOTE: Instructions [JC] and [JO] are for timer operation around the Closed position. For timing around the Open position, read stop for start [JC] and start for stop [JO].

JC Position in Valve Closing Stroke for Timer to Start

Using the + or - key select the position for the **TIMER TO START WHEN THE VALVE IS CLOSING.**

[] [] Closed = valve closed
[00] to [99] = percentage open
[≡≡≡] Open = valve open

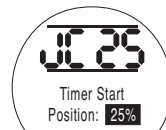

PRESS THE  KEY.

The displayed option will flash (stored) indicating that it has been set.

If the timing is not required in the closing stroke select [JC] to [] valve closed position.

JO Position in Valve Opening Stroke for Timer to Stop

Using the + or – key select the position for the **TIMER TO STOP WHEN THE VALVE IS OPENING**.

[11] Closed = valve closed
 [00] to [99] = percentage open
 [≡≡] Open = valve open



PRESS THE ← KEY.

The displayed option will flash (stored) indicating that it has been set.

If timing is not required in the opening stroke select [JO] to [11].

JS Interrupter Timer Interval

This function changes the units of time applied to [Jn] and [JF] between seconds and milliseconds.



[On] Seconds (Default)

[OF] Milliseconds

To change the time interval press the + or – key until the required setting is displayed.

PRESS THE ← KEY.

The displayed option will flash (stored) indicating that it has been set.

Jn Interrupter Timer On Time

Using the + or – key select the actuator run period in the range 100 mS to 99 seconds.



[Jn] set to 05 gives an Interrupter Timer on pulse length of 500 mS or 5 seconds depending on whether [JS] is set to [OF] or [On].

PRESS THE ← KEY.

The displayed option will flash (stored) indicating that it has been set.

Interrupter Timer Off Time

Using the + or – key select the actuator stop period in the range 100 mS to 99 seconds.



[JF] set to 25 gives an Interrupter Timer off pulse length of 2500 mS or 25 seconds depending on whether [JS] is set to [OF] or [On].

PRESS THE ← KEY.

The displayed option will flash (stored) indicating that it has been set.

JE ESD Override Interrupter Timer

The interrupter timer may be overridden when the actuator is under software ESD signal command. This will mean the actuator will run to limit without “stop/start” action under ESD command.

Refer to section 9.5 for ESD settings.

The default for ESD override interrupter timer is **[OF] No.** The interrupter timer will continue “stop/start” action during software ESD action.

If ESD must override the timer use the **+** or **-** to display **[ON] Yes.**



PRESS THE  KEY.

The displayed option will flash (stored) indicating that it has been set.

Example

An actuator fitted with the interrupter timer and set as the example shown in these instructions would operate at:

Rated speed from full Open to 25% Open.

$\frac{1}{6}$ rated speed from 25% Open to Fully Closed and from Fully Closed to 25% Open.

Rated speed from 25% Open to Fully Open.

⚠ WARNING: The interrupter timer does not operate during mains power failure on spring return actuators. Systems should take this into account.

This section allows the user to confirm a fault if allowed along with checking that the display is operating correctly. The firmware version programmed onto the various electronic boards can also be viewed here.

See section 3 for full description of fault descriptions.

The table (right) lists the available fault descriptions along with the state of the associated Monitor Relay and Fault Relay. If there is more than one fault then they will be displayed in three second intervals. After the first fault has been confirmed then the next highest priority fault can then be confirmed if allowed.

Although acceptance of the fault may permit the control of the actuator, it is probable that the fault is still present and should be investigated. A full functional test should be carried out to ensure any underlying fault does not affect the actuator performance. If the fault persists then contact Rotork.

Displayed text	Clear monitor relay	Set fault relay	CF Clears fault	Cleared automatically	Resume on new command
CONFIG ERROR	Yes	Yes	No	No	No
ELECTRONIC FAULT	Yes	Yes	Yes	No	No
LOCAL CTRL FAULT	Yes	Yes	No	Yes	No
SOL DRIVE FAULT	No	Yes	No	Yes	No
POS SENSOR FAULT	Yes	Yes	No	Yes	No
PRES SENSE FAULT	No	Yes	No	Yes	No
OP IN MID POS	No	Yes	Yes	No	Yes (move away first)
OP AT LIMIT	No	Yes	Yes	No	Yes (move away first)
WRONG DIRECTION	No	Yes	Yes	No	No
STALL IN MID POS	No	Yes	Yes	Yes	Yes (move away first)
STALL AT LIMIT	No	Yes	Yes	Yes	Yes (move away first)
PS ERROR	No	No	Yes	Yes	Yes
DEMAND FAULT	No	Yes	No	Yes	No
PS UNABLE TO RUN	No	No	Yes	Yes	Yes
OPTION CH 1 FAULT	Yes	Yes	Yes	No	No
OPTION CH 2 FAULT	Yes	Yes	Yes	No	No
EEPROM MISSING	Yes	Yes	Yes	No	No

tL Test Lights Function

This option illuminates all the segments, dots and icons on the display along with cycling through the Red, Yellow and Green LED's.



PRESS THE  KEY.

Un Firmware Version

This option displays the current firmware version number that is installed on the actuator.



U1 Option 1 Version

This option displays the current firmware version number that is installed on Channel 1 of the network card if fitted.



U2 Option 2 Version

This option displays the current firmware version number that is installed on Channel 2 of the network card if fitted.

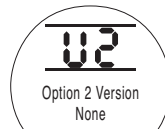

9.10 Bus System Option Pakscan

Setting instructions for actuators including an optional Pakscan Field Control Unit – check wiring diagram for inclusion.

Before setting the parameters for Option Pakscan ensure Remote Control Source [Od] has been selected to [oP] or [OE] in section 9.3.

PA Pakscan Node Address

The actuator Pakscan Field Control Unit must be allocated a unique loop node address.

The actuator must be in “Loopback” and isolated from Pakscan loop traffic for its address to be set or changed. Loopback can be achieved in two ways:

1. Turn OFF the master station.
2. Isolate the actuator from the 2-wire control loop both in & out.

Using the + or – keys display the required loop address.

Address to be set within the range 01-240 (01–F0 Hexadecimal). Refer to table in section 12.



PRESS THE ← KEY.

The displayed option will flash (stored) indicating that it has been set.

Press the → key to display:
[Pb] Baud Rate.

Pb Pakscan Baud Rate

The actuator Pakscan Field Control Unit baud rate must be set to the loop baud rate. For a Pakscan 2-wire control loop the selected baud rate must be common to the master station and all the field control units included in the loop.

The actuator must be in “Loopback” and isolated from Pakscan loop traffic for its baud rate to be set or changed.

Loopback can be achieved in two ways:

1. Turn OFF the master station.
2. Isolate the actuator from the 2-wire control loop both in & out.

Using the + or – keys display the required baud rate.

[01] = 110 baud

[03] = 300 baud

[06] = 600 baud

[12] = 1200 baud

[24] = 2400 baud



PRESS THE ← KEY.

The displayed option will flash (stored) indicating that it has been set.

Press the → key to display:
[PF] Aux I/P Mask.

PF Pakscan Remote Auxiliary Input Mask

The SI actuator has the facility to accept 4 auxiliary inputs (AUX1–AUX4). These are used when supplementary remote control or digital auxiliary inputs are required in addition to the standard control and feedback features incorporated into the Pakscan card. It is also possible to have a combination of both remote control and volt-free inputs to provide, for example, open and close control as well as a high and low tank level alarm indication, supplied via an external transducer.

The hexadecimal number displayed under PF can be considered as a “software mask”. It is this mask that tells the Pakscan card what type of input to expect, control or input signal, and what form the input will be, normally open or normally closed (*refer to section 12 for Binary, Hexadecimal and Decimal Conversion Table*).

To decipher the mask the number needs to be split into two separate hexadecimal characters, each of which can be sub-divided into 4 binary bits. The first 4 bits represent the function and the second 4 represent the input source (known as invert). Pictorially this can be represented as:

	Left side hex character	Right side hex character
	Aux 4 to 1 (function)	AUX 4 to 1 (Invert)
Bits	4 3 2 1	4 3 2 1

When used for remote control of the actuator bits 4 to 1 of the function character have been designated as follows:

Bit 4 (AUX4)	–	ESD
Bit 3 (AUX3)	–	Stop (Maintain)
Bit 2 (AUX2)	–	Close
Bit 1 (AUX1)	–	Open

(When used for digital signal inputs they are simply designated as AUX 4 to AUX 1)

Rules

1. Function bit set to “0”

Any function bit set to “0” indicates that the particular aux input is to be treated as a digital signal for field status reporting, e.g. a level switch or motor running status.

If the corresponding invert bit is set to a “0”, an open contact is reported as a logic “1” and a closed contact is reported as a logic “0” (i.e. this will invert the input).

If the corresponding invert bit is set to a “1”, an open contact is reported as a logic “0” and a closed contact is reported as a logic “1” (i.e. this gives a noninverting input).

2. Function bit set to “1”

Any function bit set to “1” indicates that the particular aux input is to be treated as a digital command to operate the actuator.

When the corresponding invert bit is set to a “0” this represents an N.C. contact as being the command source, i.e. a closing contact de-energises the input and an opening contact energises the input.

When the corresponding invert bit is set to a “1”, this represents an N.O. contact as being the command source, i.e. a closing contact energises the input and an opening contact de-energises the input.

3. ESD Control

When using ESD (aux input 4), the ESD contact mode setting **[A2]** should be set to the default value of **[O]**. The **[A1]**–ESD direction setting should be set to either Open or Close the valve (*refer to section 9.5*).

4. Stop (Maintain) Control

When energised this will make the Aux input Open/Close/ESD control push-to-run, (non-maintained).

When de-energised, the Aux input Open/Close/ESD control will be maintained.

PF Pakscan Remote Auxiliary Input (continued)

5. Remote I/P Setting

Ensure that the correct **[Od]** Control Type setting is selected (*refer to section 9.3*).

For Pakscan this is **[oP]** Network.

The factory default for **[PF]** Aux I/P Mask is **[OF]** 0000 1111.

Examples

1. The full range of remote controls is needed. Open and Close are NO and ESD and Stop/maintain is NC.

Aux I/P 4 3 2 1

Function 1 1 1 1 = F

Invert 0 0 1 1 = 3 i.e. set [PF] to [F3]

2. Open and close control is required along with 2 inverted digital signal inputs (Note that with this setting the open and close commands will be maintained.)

Aux I/P 4 3 2 1

Function 0 0 1 1 = 3

Invert 0 0 1 1 = 3 i.e. set [PF] to [33]

3. Only an ESD input is needed. The requirement is for push to run control with a NO contact input.

Aux I/P 4 3 2 1

Function 1 1 0 0 = C

Invert 1 0 0 0 = 8 i.e. set [PF] to [C8]

PF Pakscan Remote Auxiliary Input

Using the **+** or **-** keys display the required mask setting.



Auxiliary Input Mask [OF]

PRESS THE ← KEY.

The displayed option will flash (stored) indicating that it has been set.

For Pakscan module positioning settings **[OF]**, refer to section 9.14.

If Pakscan positioning control is required, **PRESS THE ↓ KEY.**

Display **[FL]** Low Set Point Position
Refer to section 9.14.

9.11 Bus System Option Modbus [OP]

Setting instructions for actuators including an optional Modbus RTU module – check wiring diagram for inclusion.

Before setting the parameters for Option Modbus ensure Remote Control Source [Od] has been selected to [oP] in section 9.3.

⚠ The actuator power must be cycled for the changes to take effect.

PA Modbus Node Address

The Modbus module must be allocated a unique address.

To set the address the Modbus module must be isolated from the host by disconnecting the RS485 highway or turning off the host device.

Using the + or – keys display the required address.

Address to be set within the range (01-247 to F7 Hexadecimal). If an address value outside this range is entered, the address set will revert to 01 (for 00) or F7 (for value above F7).



PRESS THE ← KEY.

The displayed option will flash (stored) indicating that it has been set.

Press the → key to display:
[Pb] Baud Rate.

Pb Modbus Baudrate

The Modbus module must be set to the RS485 highway baudrate. To set the baudrate the Modbus module must be isolated from the host by disconnecting the RS485 highway or turning off the host device.

Using the + or – keys display the required baudrate:

[01] = 110	[06] = 600
[03] = 300	[24] = 2400
[12] = 1200	[96] = 9600
[48] = 4800	[38] = 38400
[19] = 19200	[11] = 115200
[57] = 57600	



PRESS THE ← KEY.

The displayed option will flash (stored) indicating that it has been set.

Press the → key to display:
[PF] Aux I/P Mask.

The SI *Pro* actuator has the facility to accept 4 auxiliary inputs (AUX1 – AUX4). These are used when supplementary remote control or digital auxiliary inputs are required in addition to the standard remote control and feedback features incorporated into the Modbus module. It is also possible to have a combination of both remote control and volt-free inputs to provide, for example, open and close control as well as a high and low tank level alarm indication, supplied via an external transducer.

The hexadecimal number displayed under PF can be considered as a “software mask”. It is this mask that tells the Modbus module what type of input to expect, control or input signal, and what form the input will be, normally open or normally closed. Refer to section 12 for Binary, Hexadecimal and Decimal Conversion Table.

To decipher the mask the number needs to be split into two separate hexadecimal characters, each of which can be sub-divided into 4 binary bits. The first 4 bits represent the function and the second 4 represent the input source (known as invert). Pictorially this can be represented as:

	Left side hex character	Right side hex character
	Aux 4 to 1 (function)	AUX 4 to 1 (invert)
Bits	4 3 2 1	4 3 2 1

When used for remote control of the actuator bits 4 to 1 of the function character have been designated as follows:

Bit 4 (AUX4)	–	ESD
Bit 3 (AUX3)	–	Stop (Maintain)
Bit 2 (AUX2)	–	Close
Bit 1 (AUX1)	–	Open

(When used for digital signal inputs they are simply designated as AUX 4 to AUX 1.)

Rules

1. Function bit set to “0”

Any function bit set to “0” indicates that the particular aux input is to be treated as a digital signal for field status reporting, e.g. a level switch or motor running status.

If the corresponding invert bit is set to a “0”, an open contact is reported as a logic “1” and a closed contact is reported as a logic “0” (i.e. this will invert the input).

If the corresponding invert bit is set to a “1”, an open contact is reported as a logic “0” and a closed contact is reported as a logic “1” (i.e. this gives a noninverting input).

2. Function bit set to “1”

Any function bit set to “1” indicates that the particular aux input is to be treated as a digital command to operate the actuator.

When the corresponding invert bit is set to a “0” this represents an N.C. contact as being the command source, i.e. a closing contact de-energises the input and an opening contact energises the input.

When the corresponding invert bit is set to a “1”, this represents an N.O. contact as being the command source, i.e. a closing contact energises the input and an opening contact de-energises the input.

3. ESD Control

When using ESD (aux input 4), the ESD contact mode setting **[A2]** should be set to the default value of **[NO]**. The **[A1]**–ESD direction setting should be set to either Open or Close the valve. Refer to section 9.5.

4. Stop (Maintain) Control

When energised this will make the Aux input Open/Close control push-to-run. When de-energised, the Aux input Open/Close control will be maintained. ESD is always push to run (non maintained).

5. Remote I/P Setting

Ensure that the correct **[Od]** Control Type setting is selected (*refer to section 9.3*).

For Modbus this is **[OP]** Network.

The factory default for **[PF]** Aux I/P Mask is **[OF]** 0000 1111.

Examples

1. The full range of remote controls is needed. Open and Close are NO and ESD and Stop/maintain is NC.

Aux I/P 4 3 2 1

Function 1 1 1 1 = F

Invert 0 0 1 1 = 3 i.e. set **[PF]** to **[F3]**

2. Open and close control is required along with 2 inverted digital signal inputs. (Note that with this setting the open and close commands will be maintained.)

Aux I/P 4 3 2 1

Function 0 0 1 1 = 3

Invert 0 0 1 1 = 3 i.e. set **[PF]** to **[33]**

3. Only an ESD input is needed. The requirement is for push to run control with a NO contact input.

Aux I/P 4 3 2 1

Function 1 1 0 0 = C

Invert 1 0 0 0 = 8 i.e. set **[PF]** to **[C8]**

Using the + or – keys display the required mask setting.



PRESS THE ← KEY.

The displayed option will flash (stored) indicating that it has been set.

Press the → key to display:
[PP] Modbus Parity.

Where Modbus parity bit detection is used the module must be set with the parity bit setting of the host.

Using the + or – keys display the required parity bit:

[No] None (no) parity bit

[En] Even parity bit

[Od] Odd parity bit



No Parity Bit

PRESS THE ← KEY.

The displayed option will flash (stored) indicating that it has been set.

For Modbus module positioning settings and action on loss of signal setting **[OF]** (*refer to section 9.14*).

If Modbus positioning control and action on loss of communication are required, **PRESS THE ↓ KEY.**

Display **[FL]** Low Set Point Position
Refer to section 9.14.

9.12 Bus System Option Profibus DP [OP]

Setting instructions for actuators including an optional Profibus DP module – check wiring diagram for inclusion.

Before setting the parameters for Option Profibus ensure Remote Control Source [Od] has been selected to [oP] in section 9.3.

⚠ Any settings made locally at the actuator may be overwritten by the host on startup unless the GSD files are locked on the Profibus card. Refer to publication PUB088-004-00 available from www.rotork.com

⚠ The actuator power must be cycled for the changes to take effect.

PA Profibus Node Address

The Profibus DP module must be allocated a unique address.

To set the address the Profibus module must be isolated from the host by disconnecting the RS485 highway or turning off the host device.

Using the + or – keys display the required address.

Address to be set within the range (01-126 to 7E Hexadecimal) (*refer to page 79 for conversion*). If an address value outside this range is entered, the address set will revert to 01 (for 00) or 7E (for value above 7E).



PRESS THE ← KEY.

The displayed option will flash (stored) indicating that it has been set.

Press the → to display:
[Pb] Baud Rate.

⚠ [Pb] has no relevance for the Rotork Profibus DP Mk.2 card.

Therefore, if the Rotork Profibus DP Mk.2 card is fitted, press the → to display:
[PF] Aux I/P Mask.

PF Profibus Remote Auxiliary Input

The SI *Pro* actuator has the facility to accept 4 auxiliary inputs (AUX1–AUX4). These are used when supplementary remote control or digital auxiliary inputs are required in addition to the standard control and feedback features incorporated into the Profibus module. It is also possible to have a combination of both remote control and volt-free inputs to provide, for example, open and close control as well as a high and low tank level alarm indication, supplied via an external transducer.

The hexadecimal number displayed under PF can be considered as a “software mask”. It is this mask that tells the Profibus module what type of input to expect, control or input signal, and what form the input will be, normally open or normally closed (*refer to section 12 for Binary, Hexadecimal and Decimal Conversion Table*).

To decipher the mask the number needs to be split into two separate hexadecimal characters, each of which can be sub-divided into 4 binary bits. The first 4 bits represent the function and the second 4 represent the input source (known as invert). Pictorially this can be represented as:

	Left side hex character Aux 4 to 1 (function)	Right side hex character AUX 4 to 1 (invert)
Bits	4 3 2 1	4 3 2 1

When used for remote control of the actuator bits 4 to 1 of the function character have been designated as follows:

Bit 4 (AUX4)	–	ESD
Bit 3 (AUX3)	–	Stop (Maintain)
Bit 2 (AUX2)	–	Close
Bit 1 (AUX1)	–	Open

(When used for digital signal inputs they are simply designated as AUX 4 to AUX 1.)

Rules

1. Function bit set to “0”

Any function bit set to “0” indicates that the particular aux input is to be treated as a digital signal for field status reporting, e.g. a level switch or motor running status.

If the corresponding invert bit is set to a “0”, an open contact is reported as a logic “1” and a closed contact is reported as a logic “0” (i.e. this will invert the input).

If the corresponding invert bit is set to a “1”, an open contact is reported as a logic “0” and a closed contact is reported as a logic “1” (i.e. this gives a noninverting input).

2. Function bit set to “1”

Any function bit set to “1” indicates that the particular aux input is to be treated as a digital command to operate the actuator.

When the corresponding invert bit is set to a “0” this represents an N.C. contact as being the command source, i.e. a closing contact de-energises the input and an opening contact energises the input.

When the corresponding invert bit is set to a “1”, this represents an N.O. contact as being the command source, i.e. a closing contact energises the input and an opening contact de-energises the input.

3. ESD Control

When using ESD (aux input 4), the ESD contact mode setting **[A2]** should be set to the default value of **[NO]**. The **[A1]**–ESD direction setting should be set to either open or close the valve (*refer to section 9.5*).

4. Stop/Maintain Control

When energised this will make the Aux input Open/Close control push to run. When de-energised, the Aux input Open/Close control will be maintained. ESD is always push to run (non maintained).

PF Profibus Remote Auxiliary Input (continued)

5. Remote Source Setting [Od]

Ensure that the correct [Od] Control Type setting is selected (*refer to section 9.3*).

For Profibus this is [OP] Network.

The factory default for [PF] Aux I/P Mask is [OF] 0000 1111.

Examples

1. The full range of remote controls is needed. Open and Close are NO and ESD and Stop/maintain is NC.

Aux I/P 4 3 2 1

Function 1 1 1 1 = F

Invert 0 0 1 1 = 3 i.e. set [PF] to [F3]

2. Open and close control is required along with 2 inverted digital signal inputs. (Note that with this setting the open and close commands will be maintained.)

Aux I/P 4 3 2 1

Function 0 0 1 1 = 3

Invert 0 0 1 1 = 3 i.e. set [PF] to [33]

3. Only an ESD input is needed. The requirement is for push to run control with a NO contact input.

Aux I/P 4 3 2 1

Function 1 1 0 0 = C

Invert 1 0 0 0 = 8 i.e. set [PF] to [C8]

PF Profibus Remote Auxiliary Input

Using the + or – keys display the required mask setting.



PRESS THE ← KEY.

The displayed option will flash (stored) indicating that it has been set.

If Profibus positioning control and action on loss of communication are required, **PRESS THE ↓ KEY.**

Display [FL] Low Set Point Position
Refer to section 9.14.

9.13 Bus System Option DeviceNet

Setting instructions for actuators including an optional DeviceNet DFU module – check wiring diagram for inclusion.

Before setting the parameters for Option DeviceNet ensure Remote Control Source [Od] has been selected to [oP] in section 9.3.

⚠ The actuator power must be cycled for the changes to take effect.

PA DeviceNet Node Address

The DeviceNet module must be allocated a unique address.

Using the **+** or **-** keys display the required address.

Address to be set within the range (01-63 to 3F Hexadecimal). See page 79 for conversion. If an address value outside this range is entered, the address set will revert to 01 (for 00) or 3F (for value above 3F).



PRESS THE ← KEY.

The displayed option will flash (stored) indicating that it has been set.

Press the **→** key to display:
[Pb] Baud Rate.

Pb DeviceNet Baudrate

The DeviceNet module must be set to the DeviceNet highway baudrate.

Using the **+** or **-** keys display the required baudrate:

[01] = 125 k baud

[03] = 250 k baud

[06] = 500 k baud

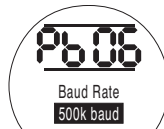

PRESS THE ↺ KEY.

The displayed option will flash (stored) indicating that it has been set.

Press the **→** key to display:
[PF] Aux I/P Mask.

PF DeviceNet Remote Auxiliary Input

The SI Pro actuator has the facility to accept 4 auxiliary inputs (AUX1–AUX4). These are used when supplementary remote control or volt free digital auxiliary inputs are required in addition to the standard control and feedback features incorporated into the DeviceNet module. It is also possible to have a combination of both remote control and volt free inputs to provide, for example, open and close control as well as a high and low tank level alarm indication, supplied via an external transducer.

The hexadecimal number displayed under PF can be considered as a “software mask”. It is this mask that tells the DeviceNet module what type of input to expect, control or input signal, and what form the input will be, normally open or normally closed.

To decipher the mask the number needs to be split into two separate hexadecimal characters, each of which can be sub-divided into 4 binary bits. The first 4 bits represent the function and the second 4 represent the input source (known as invert). Pictorially this can be represented as:

	Left side hex character	Right side hex character
	Aux 4 to 1 (function)	AUX 4 to 1 (Invert)
Bits	4 3 2 1	4 3 2 1

When used for remote control of the actuator bits 4 to 1 of the function character have been designated as follows:

Bit 4 (AUX4)	–	ESD
Bit 3 (AUX3)	–	Stop (Maintain)
Bit 2 (AUX2)	–	Close
Bit 1 (AUX1)	–	Open

(When used for digital signal inputs they are simply designated as AUX 4 to AUX 1.)

Rules

1. Function bit set to “0”

Any function bit set to “0” indicates that the particular aux input is to be treated as a digital signal for field status reporting, e.g. a level switch or motor running status. If the corresponding invert bit is set to a “0”, an open contact is reported as a logic “1” and a close contact is reported as a logic “0” (i.e. this will invert the input).

If the corresponding invert bit is set to a “1”, an open contact is reported as a logic “0” and a close contact is reported as a logic “1” (i.e. this gives a non-inverting input).

2. Function bit set to “1”

Any function bit set to “1” indicates that the particular aux input is to be treated as a digital command to operate the actuator.

When the corresponding invert bit is set to a “0” this represents an N.C. contact as being the command source, i.e. a closing contact de-energises the input and an opening contact energises the input.

When the corresponding invert bit is set to a “1”, this represents an N.O. contact as being the command source, i.e. a closing contact energises the input and an opening contact de-energises the input.

3. ESD Control

When using ESD (aux input 4), the ESD contact mode setting **[A2]** should be set to the default value of **[NO]**. The **[A1]** – ESD direction setting should be set to either open or close the valve (*refer to section 9.5*).

4. Stop (Maintain) Control

When energised this will make the Aux input Open/Close control push-to-run. When de-energised, the Aux input Open/Close control will be maintained. ESD is always push to run (non maintained).

PF DeviceNet Remote Auxiliary Input (continued)

5. Remote I/P Setting

Ensure that the correct **[Od] Control Type** setting is selected (*refer to section 9.3*).

For DeviceNet this is **[OP] Network**.

The factory default for **[PF] Aux I/P Mask** is **[OF] 0000 1111**.

Examples

1. The full range of remote controls is needed. Open and Close are NO and ESD and Stop/maintain is NC.

Aux I/P 4 3 2 1

Function 1 1 1 1 = F

Invert 0 0 1 1 = 3 i.e. set [PF] to [F3]

2. Open and close control is required along with 2 inverted digital signal inputs. (Note that with this setting the open and close commands will be maintained.)

Aux I/P 4 3 2 1

Function 0 0 1 1 = 3

Invert 0 0 1 1 = 3 i.e. set [PF] to [33]

3. Only an ESD input is needed. The requirement is for push to run control with a NO contact input.

Aux I/P 4 3 2 1

Function 1 1 0 0 = C

Invert 1 0 0 0 = 8 i.e. set [PF] to [C8]

Using the **+** or **-** keys display the required mask setting.



PRESS THE  KEY.

The displayed option will flash (stored) indicating that it has been set.

For DeviceNet module positioning settings and action on loss of signal setting **[OF]**. *Refer to section 9.14.*

9.14 Bus System Positioning Control Settings

If the system control strategy for Pakscan, Modbus, DeviceNet or Profibus requires intermediate valve travel positioning to a "DV" (Desired Value - value corresponding to required position), the control parameters in this section need to be set. "Action on Loss of Signal" parameters apply only to Modbus and Profibus systems.

Limited Range Positioning is a selectable option whereby positioning limits, 0% and 100%, can be at different positions to those used for digital Closed and Open limit commands. Limited range positioning can be set using the **[FL] Low Set Point Position** and **[FH] High Set Point Position** screens.

It should be noted that the actuator will respond to a digital Open or Close host command by moving the valve to the set limits irrespective of settings made for positioning control.

Settings for Deadband and Motion Inhibit Time affect accuracy and response time.

⚠ Any settings made locally at the actuator may be overwritten by the host on startup unless the GSD files are locked on the Profibus card. Refer to publication PUB088-004-00 available from www.rotork.com

FL Bus System Valve Position at 0% DV

[FL] Low Set Point Position is the position to which the actuator will move if a 0% command is sent.

Note that the position set for **[FL]** will be reported to the host as 0%. The actuator display will report % open in the range set by the limits.

The default setting is for 0% to be the Close limit.

Use the **+** or **-** key to select the desired valve position for a 0% command.



0% DV = Valve Closed

PRESS THE ← KEY.

The displayed option will flash (stored) indicating that it has been set.

Press the **→** key to display:
[FH] High Set Point Position.

FH Bus System Valve Position at 100% DV

[FH] High Set Point Position is the position to which the actuator will move if a 100% command is sent.

Note that the position set for **[FH]** will be reported to the host as 100%. The actuator display will report % open in the range set by the limits.

The default setting is for 100% to be the Open limit.

Use the **+** or **-** key to select the desired valve position for a 100% command.



100% DV = Valve Open

PRESS THE ← KEY.

The displayed option will flash (stored) indicating that it has been set.

Press the **→** key to display:
[Fd] Deadband.

Fd Bus System Deadband Adjustment

63

All positioning commands are subject to a deadband tolerance.

The deadband sets the expected positioning accuracy of the actuator and is dependent on various factors including, actuator output speed, number of turns and valve torque. If the deadband is set too low the valve may "hunt" around the set point.

Use the **+** or **-** key to display the required setting:

[00] to [99] – 0% to 9.9% of valve stroke.

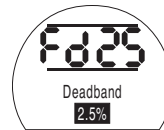

PRESS THE ← KEY.

The displayed option will flash (stored) indicating that it has been set.

Press the **→** key to display:
[Ft] Motion Inhibit Time.

Ft Bus System Motion Inhibit Time (MIT)

MIT sets the minimum time between successive position commands being actioned. It is used in situations to reduce the number of starts per hour and to smooth out fluctuations if continuous positioning is implemented.

Setting the longest possible time while maintaining acceptable control will maximise the life of the motorised valve.

Use the **+** or **-** key to display the required setting:

[00] to **[99]** = 0 to 99 seconds.



PRESS THE ← KEY.

The displayed option will flash (stored) indicating that it has been set.

Press the → key to display:

[FA] Loss of Signal
(Modbus, Profibus & Devicenet only).

FA Modbus, Profibus & DeviceNet Action on Loss of Signal

Modbus, Profibus & DeviceNet modules can be set to respond on loss of host communication by positioning the valve. Modbus checks for a loss of general highway communications whereas Profibus & DeviceNet check for a loss of communications addressed specifically to themselves.

The default setting is off **[OF]** and the default timeout is 255 sec.

Use the **+** or **-** key to display the required setting:

[ON] Failsafe as determined by setting **[FF]**

[OF] Go to Low SP position.



Failsafe Action Enabled

PRESS THE ← KEY.

The displayed option will flash (stored) indicating that it has been set.

Press the → key to display:
[FF] Failsafe Action.

FF Modbus, Profibus & DeviceNet Failsafe Action

Modbus, Profibus & DeviceNet failsafe action when **[FA]** is enabled.

Use the **+** or **-** key to display the required setting:

[Lo] Go to Low SP position.

[SP] Stay put

[Hi] Go to High SP position.



PRESS THE ← KEY.

The displayed option will flash (stored) indicating that it has been set.

All SI actuator functions are configured to a set of Rotork default (standard) settings before despatch, see the table opposite. When requested, alternative settings specified with the order will be used. When site commissioning takes place, entered settings overwrite Rotork defaults and these "current" settings are used for operation along with the remaining unadjusted defaults.

Should difficulty be encountered during commissioning the default settings can be reinstated, returning the actuator configuration to its original manufactured state. Site commissioning must then begin again.

If reset to factory defaults takes place, all Basic and Configuration Settings except limit positions will return to their default setting. See the table opposite for Rotork standard settings. Basic settings (except limits) and Configuration settings must then be checked and reset as required. Refer to *Basic Settings, section 8* and *Configuration Settings, section 9*.

Rotork standard default settings for SI actuators:

Function	[d1] Default Setting
[P?] Password	Unaffected – will remain as set
[Bt] Bluetooth Communication	[OF] Switched Off

Basic Configurations

[C2] Close Action	[CP] Stop on Pressure
[C3] Open Action	[OL] Stop on Limit
[CP] Close Pressure at Limit	[90] 90% of Maximum Pressure
[Cp] Close Pressure at Mid	[00] 00% = Value set in CP
[OP] Open Pressure at Limit	[90] 90% of Maximum Pressure
[Op] Open Pressure at Mid	[00] 00% = Value set in OP

Configuration Settings

[r1] Relay 1 Function	[CL] Closed Limit
[r1] Relay 1 Form	[nO] Normally Open
[r2] Relay 2 Function	[OP] Open Limit
[r2] Relay 2 Form	[nO] Normally Open
[r3] Relay 3 Function	[FA] Fault Alarm
[r3] Relay 3 Form	[nO] Normally Open
[Od] Remote Select	[rE] Digital
[cL] Local Control	[Pr] Push to Run
[LP] Low Power Mode	[OF] Switched Off
[Ld] Closed LED Colour	[9r] Green
[UL] Language	[01] English
[rP] Remote Priority	[SP] Stayput
[HP] Hold Position	[On] Switched On
[PH] Position Hysteresis	[05] 0.5%
[OH] Over Pressure Hysteresis	[10] 10%
[UH] Under Pressure Hysteresis	[10] 10%
[EA] ESD Action (Software)	[E] De-energise all Solenoid Valves
[EO] ESD Local Stop Override	[No] No Override
[Ec] ESD Contact Type	[nO] Normally Open
[rE] ESD Manual Reset	[OF] No Reset

Ur**Reset to Default** *continued*

[Et]	ESD Temp Loss of Signal	[Ct]	Continue with ESD Action
[PP]	Partial Stroke Position	[90]	90% Open
[Ph]	Partial Stroke Test – Motor Start	[No]	Do not start motor when test commences
[FI]	mA / Voltage Analogue Input	[CU]	Current
[FF]	Analogue Signal Failure Action	[OF]	No Alarm
[dC]	Closing Deadband Adjustment	[10]	1.0%
[dO]	Opening Deadband Adjustment	[10]	1.0%
[HC]	Closing Hysteresis Adjustment	[05]	0.5%
[HO]	Opening Hysteresis Adjustment	[05]	0.5%
[OJ]	Interrupter Timer Enable	[OF]	Timer Off
[Jd]	Interrupter Timer Start Direction	[CL]	Start Closing
[JC]	Interrupter Timer Close Position	[25]	25% Open
[JO]	Interrupter Timer Open Position	[25]	25% Open
[JS]	Interrupter Timer Interval	[OF]	Time in Seconds
[JE]	Interrupter Timer ESD Override	[OF]	No Override



Pressing  opens a second menu

Confirm action?

[no] Cancels the requested action
(Default)

[yS] Confirms the requested action

PRESS THE  KEY.

10.1 Maintenance, Monitoring and Troubleshooting

Every Rotork actuator has been fully tested before despatch to give years of trouble-free operation providing it is installed, sealed and commissioned in accordance with the instructions given in this publication.

The SI actuator's unique double-sealed, non-intrusive enclosure provides complete protection for the actuator components. Covers should not be removed for routine inspection as this may be detrimental to the future reliability of the actuator. The control module contains no user serviceable components. The oil reservoir cover should not be removed as it contains hydraulic oil.

All electrical power supplies to the actuator must be isolated before any maintenance or inspection is carried out.

Electrical supplies must be isolated before actuator covers are removed.

If the motorised valve is rarely operated, a routine operating schedule should be set up, which may include partial stroking the actuator at regular intervals.

Routine maintenance should include the following on an annual basis:

- Check actuator to valve fixing bolts for tightness.
- Ensure valve stems and drive nuts are clean and properly lubricated.
- Check the actuator enclosure for damage, loose or missing fasteners.
- Ensure there is not an excessive build up of dust or contaminant on the actuator.
- Cleaning must only be carried out with a damp cloth.
- Check for any loss of hydraulic fluid. This can be done by removing the oil fill plug when the electrical power is removed from the actuator. The oil level should be within 50mm (2") of the oil fill plug sealing face of the casting. If it is necessary to top up hydraulic fluid ensure that the correct type of fluid is used. See actuator name plate. It may be necessary to remove the actuator from the valve to carry this out.
- If the oil level is low, visually inspect the actuator and tighten any hydraulic fittings that may be leaking.

- Check the operating speeds in both the open and closed directions against the test certificate supplied with the actuator.
- Fully open the actuator and turn the red local control knob to stop. Leave the actuator for 30 minutes and check that the actuator has not drifted off the open limit.

Routine maintenance should include the following after 5 years of service:

- The hydraulic oil should be replaced after 5 years if the actuator is operating a modulating valve and 10 years if operating a isolating valve (Refer to Weights and Measures, section 12, for the volume of oil required).
- The actuator seals should be replaced after 5 years if the actuator is operating a modulating valve and 10 years if operating an isolating valve.

See the SI Workshop Manual for any other service work that requires carrying out on the actuator, including replacing the oil and actuator seals above.

Hydraulic Oil

Standard Applications 10 cSt Mineral Oil

Unless specially ordered for extreme climate conditions or other special environments, Rotork SI actuators are despatched with hydraulic systems filled with 10 cSt mineral oil. This oil is suitable for actuators operating in ambient temperatures in the range -15 to +65 °C.

Low Temperature Environments 10 cSt Silicone Fluid.

This oil is suitable for actuators operating in ambient temperatures in the range -40 to +65 °C.

Sensitive Environments 15 cSt Bio-degradable Fluid.

This oil is suitable for actuators operating in ambient temperatures in the range -10 to +65 °C.

Food Industry Environments 15 cSt Food Grade Fluid.

This oil is suitable for actuators operating in ambient temperatures in the range -10 to +65 °C.

Troubleshooting

See Fault Alarms in section 9.9 and Help Screens in section 11.

10.2 Environmental

End user advice on disposal at end of life of the product

Subject	Definition	Remarks / examples	Hazardous	Recyclable	EU Waste Code	Disposal
Electrical & Electronic Equipment	Printed circuit boards Wire LS1 is tripped	All Products All Products	Yes	Yes	20 01 35	Use specialist recyclers
			Yes	Yes	17 04 10	
Glass	Lens/Window	All SI actuators	No	Yes	16 01 20	Use specialist recyclers
Metals	Aluminium Copper/Brass Steel Mixed Metals	Power unit & Quarter-turn enclosure Pump parts, SI-2 motor windings, Wire Linear actuator & Q100 to Q130 actuators SI-2 motors	No	Yes	14 04 02	Use licensed recyclers
			No	Yes	17 04 01	
			No	Yes	17 05 05	
			No	Yes	17 04 07	
Plastics	Glass filled nylon	Covers, electronics chassis	No	No	17 02 04	Use specialist recyclers
Oil	Mineral Food Grade Silicone	Standard actuator Food industry applications Low temp applications	Yes	Yes	13 01 10	Will require special treatment before disposal, use specialist recyclers or waste disposal companies
			Yes	Yes	13 01 12	
			Yes	Yes	13 01 11	
Rubber	Seals & O-rings	Cover and shaft sealing	Yes	No	16 01 99	May require special treatment before disposal, use specialist waste disposal companies

In all cases, check local authority regulations before disposal.

With the actuator powered up and Local or Stop selected, nine Help Screens can be accessed using the Setting Tool. Refer to section 8.1 for their location.

With Remote selected press the ↓ key on the Setting Tool. The Help Screens will be displayed.

Each screen uses bars to indicate the status of a particular control or indication function. Each bar reacts to changes in the status of its actuator function by turning "on" or "off".

For troubleshooting, access the following Help Screens and refer to text:

- H1** – Actuator limit status indicators.
- H2** – Local control indicators.
- H3** – Remote signal indicators.
- H4** – Digital feedback indicators.
- H5** – Timer, fault and monitor relay indicators.
- H6** – Solenoid and pump driver outputs.
- H7** – Fault indicators 1.
- H8** – Fault indicators 2.
- H9** – Driver logic indicators.

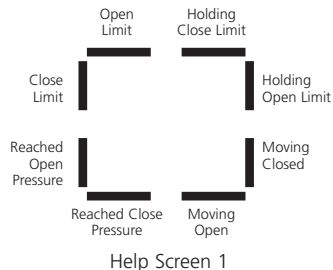

Open Limit

Bar On = Actuator has reached Open Limit.

Close Limit

Bar On = Actuator has reached Close Limit.

Reached Open Pressure

Bar On = Actuator has reached Open pressure.

Reached Close Pressure

Bar On = Actuator has reached Close pressure.

Moving Open

Bar On = Actuator is moving in the Open direction.

Moving Closed

Bar On = Actuator is moving in the Closed direction.

Holding Open Limit

Bar On = Actuator is maintaining Open Limit position.

Holding Close Limit

Bar On = Actuator is maintaining Close Limit position.

Note: Bar indication is real time and reactive.

Cr HP Local Controls H2

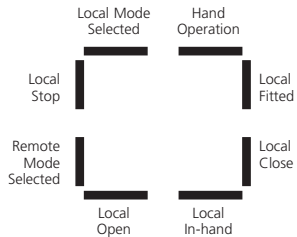

Help Screen 2

Local Fitted
Bar On = Local controls fitted.

Hand Operation
Bar On = Manual override in use.

Note: Bar indication is real time and reactive.

Local Mode Selected
Bar On = Local Control selected.

Local Stop
Bar On = Local Stop selected.

Remote Mode Selected
Bar On = Remote Control selected.

Local Open
Bar On = Local Open selected.

Local In-hand
Bar On = Neither local open or local closed selected.

Local Close
Bar On = Local Close pushbutton operated.

Cr HP Remote Signals H3

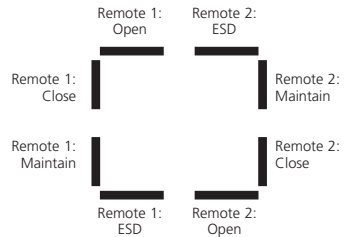

Help Screen 3

Remote 1: ESD
Bar On = ESD signal present.

Remote 2: Open
Bar On = Remote Open signal present from network.

Remote 2: Close
Bar On = Remote Close signal present from network.

Remote 2: Maintain
Bar On = Remote Maintain signal present from network.

Remote 2: ESD
Bar On = ESD signal present from network.

Note: Bar indication is real time and reactive.

All remote signals designated with "1" are standard hard wired remote inputs.

When a network system such as Pakscan, Profibus or Foundation Fieldbus is in use, remote control inputs are designated with a "2".

Remote 1: Open
Bar On = Remote Open Signal Present.

Remote 1: Close
Bar On = Remote Close Signal Present.

Remote 1: Maintain
Bar On = Remote Maintain signal present.

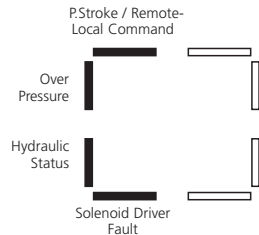

Help Screen 4

Partial Stroke / Remote-Local Command

Bar On = If in analogue control mode - a remote local command is present. If in hardwired remote control mode - partial stroke command is present.

Over Pressure

Bar On = Hydraulic system over pressure.

Hydraulic Status

Bar On = Hydraulic system active.

Solenoid Driver Fault

Bar On = Solenoid driver fault present.

Note: Bar indication is real time and reactive.

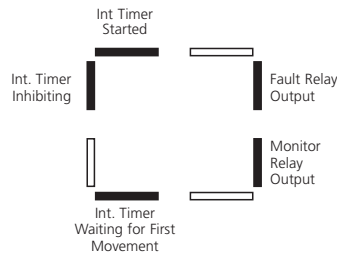

Help Screen 5

Interrupter Timer Started

Bar On = Interrupter timer running.

Interrupter Timer Inhibiting

Bar On = Interrupter timer off pulse present.

Interrupter Timer Waiting for First Movement

Bar On = Interrupter timer is waiting for first movement.

Monitor Relay Output

Bar On = Monitor relay energised.

Fault Relay Output

Bar On = Fault relay energised.

Note: Bar indication is real time and reactive.

Cr HP Driver Outputs H6

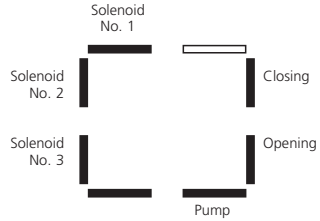

Help Screen 6

Solenoid No.1

Bar On = Solenoid No.1 energised.

Solenoid No.2

Bar On = Solenoid No.2 energised.

Solenoid No.3

Bar On = Solenoid No.3 energised.

Pump

Bar On = Pump running.

Opening

Bar On = Actuator opening.

Closing

Bar On = Actuator Closing.

Note: Bar indication is real time and reactive.

Cr HP Error Flags 1 H7

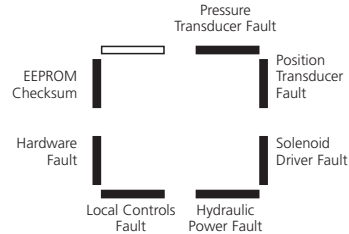

Help Screen 7

EEPROM Checksum

Bar On = EEPROM checksum error [EE].

Hardware Fault

Bar On = Hardware fault present [HA].

Local Controls Fault

Bar On = Local controls fault [LC].

Hydraulic Power Fault

Bar On = Hydraulic Power fault [PU].

Solenoid Driver Fault

Bar On = Solenoid Driver error [dr].

Position Transducer Fault

Bar On = Position Transducer error [PU].

Pressure Transducer Fault

Bar On = Pressure Transducer error [Pr].

Note: Bar indication is real time and reactive.

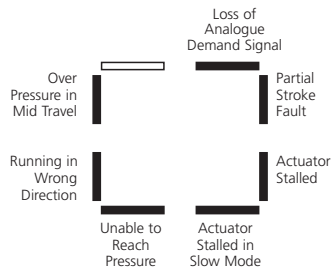

Help Screen 8

Actuator Stalled

Bar On = Actuator movement is stalled [St].

Partial Stroke Fault

Bar On = Actuator has failed to complete desired movement [PS].

Loss of Analogue Demand Signal

Bar On = Analogue demand signal not present [dn].

Note: Bar indication is real time and reactive.

Over Pressure in Mid Travel

Bar On = Actuator operation has stopped due to an obstruction in mid-travel [OP].

Running in Wrong Direction

Bar On = Actuator is running in the wrong direction [dl].

Unable to Reach Pressure

Bar On = Actuator is unable to reach required pressure [uP].

Actuator Stalled in Slow Mode

Bar On = Actuator is stalled in slow mode [SL].

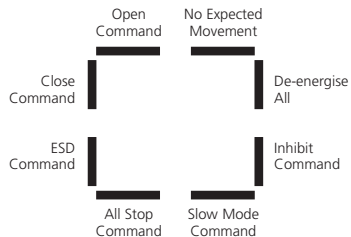

Help Screen A

Inhibit Command

Bar On = Actuator is operating using the interrupter timer.

De-energise All Command

Bar On = Actuator has command to de-energise all solenoids.

No Expected Movement

Bar On = Actuator has no commands to move.

Note: Bar indication is real time and reactive.

Open Command

Bar On = Actuator is acting on an Open command.

Close Command

Bar On = Actuator is acting on a Close command.

ESD Command

Bar On = Actuator is acting on an ESD command.

All Stop Command

Bar On = Stop actuator and pump.

Slow Mode Command

Bar On = Actuator is running at a slower rate.

12.1 Weights and Measures

Actuator Model	Nett Weight kg/lbs	Volume of Oil (litres / US Gallons)
SI-1-Q31	27 / 60	4.0 / 1.0
SI-1-Q41	30 / 66	4.5 / 1.2
SI-1-Q51	38 / 84	6.0 / 1.6
SI-1-Q60/1	42 / 93	7.0 / 1.9
SI-2.1-Q60/1	62 / 137	8.0 / 2.1
SI-2.1-Q70	98 / 216	17.0 / 4.5
SI-2.1-Q80	127 / 280	23.0 / 6.0
SI-2.1-Q110	335 / 739	18.0 / 4.8
SI-2.1-Q111	365 / 805	34.0 / 9.0
SI-2.1-Q112	465 / 1025	46.0 / 12.2

Actuator Model	Nett Weight kg/lbs	Volume of Oil (litres / US Gallons)
SI-1-L80/40	68 / 150	4.0 / 1.0
SI-1-L100/40	73 / 161	4.5 / 1.2
SI-1-L125/65	98 / 216	6.5 / 1.7
SI-1-L160/65	128 / 282	8.5 / 2.3
SI-1-L200/65	180 / 397	11.5 / 3.0
SI-2.1-L200/105	210 / 463	14.0 / 3.7
SI-2.1-L250/105	330 / 728	23.0 / 6.0
SI-2.1-L280/105	395 / 871	31.0 / 8.2
SI-2.1-L320/105	530 / 1168	41.0 / 10.8

13

Actuator Nameplate

The actuator nameplate is engraved with the following information:

Explosionproof Certification:

Details of certification when installed in hazardous environments.

Operating Temperature:

Maximum and minimum ambient temperatures for the installation.

Model Number:

Full actuator model code. See data sheet for explanation of model code.

Power Unit Number:

Model code for power unit only.

Serial Number:

Always have this to hand if contacting Rotork for assistance.

Wiring Diagram Number:

Wiring diagram will give information on the actuator specification and terminals for incoming cables.

Supply Voltage:

Compare this with power supply available on site.

Rating:

Consumption of actuator.

Cable Entries:

Specification of size and thread available for cable glands.

Enclosure:

The ingress protection rating the actuator is suitable for.

Oil Type:

Hydraulic oil type.

Unit Weight:

Weight of actuator.

Year of Manufacture:

The year the actuator was manufactured.

14

Hazardous Area Approvals**Refer to actuator nameplate for unit specific approval details.**

Rotork actuators are approved to many standards. The accompanying list was accurate as of 1st December 2018.

Refer to www.rotork.com for the latest information.

Rotork can supply actuators to national standards not listed below. For details please contact Rotork.

European – Hazardous Area**SI-1:**

ATEX (2014/34/EU) II 2 G. Ex db mb^⓪ IIB T4 Gb
Temperature -20 °C to +65 °C
Option -35 °C to +65 °C

SI-1:

ATEX (2014/34/EU) II 2 G. Ex db mb^⓪ IIC T4 Gb
Temperature -20 °C to +65 °C

SI-2.1:

ATEX (2014/34/EU) II 2 G. Ex db^⓪ IIB T4 Gb
Temperature -20 °C to +65 °C
Option -40 °C to +65 °C
Option -50 °C to +65 °C

SI-2.1:

ATEX (2014/34/EU) II 2 G. Ex db^⓪ IIC T4 Gb
Temperature -20 °C to +65 °C

International – Hazardous Area**SI-1:**

IECEX. Ex db mb^⓪ IIB T4 Gb
Temperature -20 °C to +65 °C
Option -35 °C to +65 °C

SI-1:

IECEX. Ex db mb^⓪ IIC T4 Gb
Temperature -20 °C to +65 °C

SI-2.1:

IECEX. Ex db^⓪ IIB T4 Gb
Temperature -20 °C to +65 °C
Option -40 °C to +65 °C

SI-2.1:

IECEX. Ex db^⓪ IIC T4 Gb
Temperature -20 °C to +65 °C

USA – Hazardous Area**SI-1:**

FM. Class I, Zone 1, AEx dm^⓪ IIB T4
Temperature -20 °C to +65 °C
Option -35 °C to +65 °C

SI-1:

FM. Class I, Zone 1, AEx dm^⓪ IIC T4
Temperature -20 °C to +65 °C

SI-2.1:

FM. Class I, Zone 1, AEx d^⓪ IIB T4
Temperature -20 °C to +65 °C
Option -40 °C to +65 °C

SI-2.1:

FM. Class I, Zone 1, AEx d^⓪ IIC T4
Temperature -20 °C to +65 °C

Canada – Hazardous Area
SI-1:

CSA. Class I, Zone 1, Ex db mb[Ⓞ] IIB T4
 Temperature -20 °C to +65 °C
 Option -35 °C to +65 °C

SI-1:

CSA. Class I, Zone 1, Ex db mb[Ⓞ] IIC T4
 Temperature -20 °C to +65 °C

SI-2.1:

CSA. Class I, Zone 1, Ex db[Ⓞ] IIB T4
 Temperature -20 °C to +65 °C
 Option -40 °C to +65 °C

SI-2.1:

CSA. Class I, Zone 1, Ex db[Ⓞ] IIC T4
 Temperature -20 °C to +65 °C

Brazil – Hazardous Area
Contact factory.

Ⓞ “eb” added on versions with the increased Safety terminal option, for single phase and DC Versions only.

Note:

1) Certification temperatures are not operating temperatures, see actuator nameplate for operating temperatures.

2) Do not place into service where an external heat source combined with the ambient temperature will exceed either the upper or lower operating temperatures.

See wiring diagram as stated on the data label for approved fuse details.

The maximum constructional gap (Ic), is less than that required by Table 2 of EN 60079-1: 2007 (or IEC 60079-1: 2007), as detailed below:

SI-1	Maximum Gap	Minimum L
Electrical Cover / Centre Housing (Spigot Joint)	0.150	26.20
Terminal Cover (Long & Short) / Centre Housing (Spigot Joint)	0.150	26.70
Terminal Bung / Centre Housing (Spigot Joint)	0.115	25.95
SI-2	Maximum Gap	Minimum L
Electrical Cover / Centre Housing (Spigot Joint)	0.150	26.20
Terminal Cover (Long & Short) / Centre Housing (Spigot Joint)	0.150	26.70
Terminal Bung / Centre Housing (Spigot Joint)	0.115	25.95
Motor Cover / Centre Housing (Spigot Joint)	0.150	27.00
Motor Mounting Bracket / Centre Housing (Flanged Joint)	0.080	
Motor Bushing / Motor Mounting Bracket (Spigot Joint)	-0.014 (interference fit)	28.00
Motor Shaft / Motor Bushing (Spigot Joint)	0.150	28.00
Solenoid Bonnet / Centre Housing (Flanged Joint)	0.080	

15

Special Conditions of Safe Use
(Explosion-proof Actuators) *continued*

SI-2.1	Maximum Gap	Minimum L
Electrical Cover / Centre Housing (Spigot Joint)	0.150	26.20
Terminal Cover (Long & Short) / Centre Housing (Spigot Joint)	0.150	26.70
Terminal Bung / Centre Housing (Spigot Joint)	0.115	25.95
Motor Cover / Centre Housing (Spigot Joint)	0.150	27.00
Motor Mounting Bracket / Centre Housing (Spigot Joint)	0.150	27.00
Motor Bushing / Motor Mounting Bracket (Spigot Joint)	-0.035 (interference fit)	28.00
Motor Shaft / Motor Bushing (Spigot Joint)	0.167	28.00

Note: All dimensions above are in mm.

WARNING:

All cover securing screws to be stainless steel (A4-80) to ISO 4762.

When fitted with a window manufactured in Makrolon® 6717 this window must only be installed where the risk of impact upon the viewing window is low.

This equipment includes some external non-metallic parts, including the outer protective coating. The user must ensure that equipment is not installed in a location where it may be subjected to external conditions (such as high-pressure steam) which might cause a build-up of electrostatic charges on non-conducting surfaces. For this reason, cleaning of the equipment should only be done with a damp cloth.



ATTENTION: RED PLASTIC PLUGS IN CONDUIT ENTRIES ARE FOR TRANSIT ONLY. FOR LONG TERM PROTECTION FIT SUITABLE METAL PLUGS.

ATTENZIONE: I TAPPI IN PLASTICA ROSSA PER L'ENTRATA CAVI SONO SOLO TEMPORANEI. PER UNA PROTEZIONE PERMANENTE PREGO SOSTITUIRLI CON APPOSITI TAPPI METALLICI.

ATENCIÓN: LOS TAPONES ROJOS DE PLASTICO EN LAS ENTRADAS DE CABLE SON UNICAMENTE PARA TRANSPORTE. PARA PROTECCION PERMANENTE COLOCAR TAPONES METALICOS APROPIADOS.

ACHTUNG: DIE ROTEN PLASTIKSTOPFEN SIND NUR FÜR DEN TRANSPORT GEEIGNET. FÜR DAVERHAFTEN SCHUTZ SIND DIESE GEGEN GEEIGNETE BLINDSTOPFEN AUSZÜTAUSCHEN.

ATTENTION: LES BOUCHONS PLASTIQUES ASSURENT UNE PROTECTION TEMPORAIRE. POUR UNE PROTECTION DEFINITIVE UTILISER DES BOUCHONS METALLIQUES.

注意：コンジット口の赤色プラグは、輸送用を目的としたプラグです。長期に渡る保護の場合、適切なメタルプラグをご使用ください。

注意：接线端红色塑料封口仅为运输途中使用。长期正常保护时请用金属封口。

주의: 배선인입구의 빨간색 플라스틱 플러그는 오직 임시용입니다. 오래 보관하기 위해서는 규격에 맞는 금속 플러그를 사용하십시오.



Keeping the World Flowing

Leeds, UK

Rotork Fluid Systems

tel +44 (0)113 256 7922
email gbleeds.skillsupport@rotork.com

USA

Rotork Controls Inc.

tel +1 (585) 247 2304
email info@rotork.com

Lucca, Italy

Rotork Fluid Systems

tel +39 05832221
email aftersales.rfs@rotork.com

Shanghai, China

Rotork

tel +86 21 5445 2910
email mail@rotork.com

If your Rotork actuator has been correctly installed and sealed, it will give years of trouble-free service.

Should you require technical assistance or spares, Rotork guarantees the best service in the world. Contact your local Rotork representative or the factory direct at the address on the nameplate, quoting the actuator type and serial number.

A full listing of our worldwide sales and service network is available on our website.

www.rotork.com

Original instructions: English language version only. As part of a process of on-going product development, Rotork reserves the right to amend and change specifications without prior notice. Published data may be subject to change. For the very latest version release, visit our website at www.rotork.com

The name Rotork is a registered trademark. Rotork recognises all registered trademarks. Published and produced in the UK by Rotork. POWTG0319

PUB021-033-00
Date of issue 03/19
