

PD8-6210/PD8-6310

ProtEX-MAX™ Dual-Line 6-Digit Batch Controllers



PD8-6210 Analog Input

PD8-6310 Pulse Input



BATCH CONTROL

COMMON BATCH CONTROLLER FEATURES

- Start / Pause / Stop, Change Batch with Front Panel Buttons
- Display Batch Total, Rate, Grand Total, Count or Preset
- Single or Multi-Stage Batch Control (Up to 8 Relays)
- Automatic Overrun Correction
- Rate in Units per Second, Minute, Hour, or Day
- Automatic or Manual Batch Control
- Low or High Flow Alarms while Batching
- 9 Digit Grand Total with Overflow Feature
- Count Up or Down with Each Batch

COMMON ProtEX-MAX™ METER FEATURES

- NEMA 4X, IP65 Front
- Universal 85-265 VAC or 12-24 VDC Input Power
- Dual-Line 6-Digit Display, 0.60" & 0.46"
- Programmable Displays & Function Keys
- SunBright Display Standard
- 2 or 4 Relays + Isolated 4-20 mA Output Options
- External 4-Relay & Digital I/O Expansion Modules
- RS-232, & RS-485 Serial Communications
- On-Board Digital Input
- Modbus® RTU Communication Protocol Standard
- Onboard USB and MeterView® Pro Programming Software

ANALOG INPUTS

- 0-20 mA, 4-20 mA, 0-5 V, 1-5 V, and ± 10 V Inputs

PULSE INPUTS

- Pulse, Open Collector, NPN, PNP, TTL, Switch Contact, Sine Wave (Coil), Square Wave Inputs

PD8-6210 / PD8-6310 ProtEX-MAX™ Batch Controllers

SAFE TOUCH® Through-Glass Button Programming



FM APPROVED SP Ex CE IECEx



Sunlight Readable Display



Mounting Flanges (Up to 2½" Pipe)

Locking Screw

SafeTouch® Menu Button

Large 0.6" Digits On Upper Display

Batch Preset

Two ¾" NPT Conduit Plugs

SafeTouch® Start Key or Right Arrow



SafeTouch® Stop Key or Alarm Acknowledge Button

Current Batch Quantity

Total Indicator

Explosion-Proof Die-Cast Aluminum NEMA 4X Enclosure

Start, Batch Preset, Stop Keys

Batch Control & Alarm Relays

SafeTouch® Batch Preset Key or Up Arrow

INTUITIVE BATCH CONTROL

The front panel has intuitive buttons and displays that make operating the batch controller clear and easy right out of the box. START, BATCH, and STOP buttons come setup by default for batch controller operation. The START button is used to begin a batching process. The BATCH button is used to quickly access the preset value. The STOP button can be pressed once to pause a batch, or twice to cancel a batch in progress. The upper and lower displays can be easily configured for your application need. The STOP button may be used to easily cycle the lower display information while the batch is stopped.

Easily Choose Your Display Information



Batch Total & Preset

The preset on the lower display provides even quicker access to the preset menu just by using the arrow keys to change the value.



Batch Total & Rate

The rate on the lower display may be alternated with units for variable flow batching systems. Rate alarms may also be used during the batch process.



Batch Total & Batch Count

The batch count on the lower display, tracks completed batches. The count may be set back to 0 with the reset menu.



Batch Total & Grand Total

A grand total with overflow digits for up to a 9 digit total may be displayed in the lower display, with password protection and non-resettable programmable features.

Clearly Labeled Displays

The upper display alternates the display to show the controller state when in pause or stop mode. When displaying rate, grand total, batch count, or preset, the lower display alternates between the display value and the function or unit of measure.



Batch Total & Preset



Alternating Display

Grand Total Displays Up to 9 Digits

These batch controllers can display up to nine digits of total flow with the grand total feature. In the diagrams below, the batch controller is displaying 532,831,470 by toggling between a display of "oF 532" and "831470". Notice the (GT with arrow ▲ symbol) is lit up indicating the display is in a grand total overflow mode.



Easy to Use

The user friendly dual-line display makes the ProtEX-MAX easy to set up & program. No jumpers to set for input selection. All setup & programming are done via the front panel.



Input Setup



Display Setup

COMMON PROTEX-MAX FEATURES

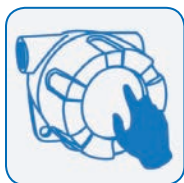

SafeTouch® Button Programming

The ProtEX-MAX is equipped with four sensors that operate as through-glass buttons so that it can be programmed and operated without removing the cover (and exposing the electronics) in a hazardous area. The SafeTouch buttons are configured by default to duplicate the function of the front panel mechanical pushbuttons associated with the integrated meter.

Standard SunBright LED Display

The ProtEX-MAX's SunBright display features extraordinarily bright LEDs. They are perfect for indoor and outdoor applications where visibility may be impaired by smoke, fog, dust, or distance or even in direct sunlight.

Free USB Programming Software & Cable

The ProtEX-MAX™ comes preloaded with free **MeterView® Pro** programming software that connects and installs directly to your PC with a standard USB cable, also provided free with each instrument. This eliminates the need to insert CDs, install drivers, or download software from the internet. The software will allow you to configure, monitor, and datalog a ProtEX-MAX™ PD8-6210/6310 using your PC. Just simply connect the meter to your PC with the USB cable and within minutes you will be programming it.

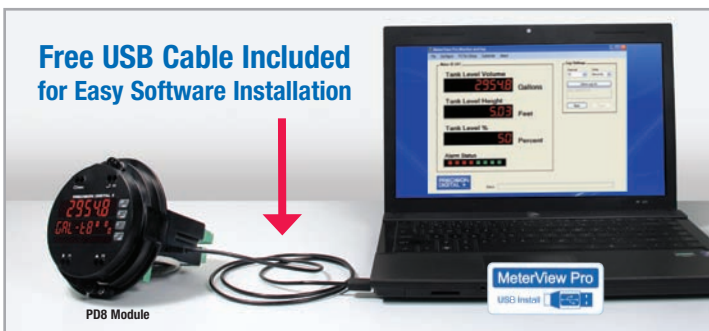

BATCH CONTROLLER CAPABILITIES

A ProtEX-MAX batch controller can be programmed for a wide variety of applications. Setup is easy for single or multi-stage batching. Automatic overrun correction keeps the batch size accurate, even over time and with system wear. It can record grand total, or non-resettable grand total with a time base of seconds, minutes, hours or days. The user can program a conversion factor, and configure a non-resettable grand total, and password protection.

Manual or Automatic Batch Control

Batches may be started manually with the START front panel button, or with a remote digital input trigger. Batches may also be programmed to start automatically after a 0 to 999.9 second delay after the end of the last completed batch. A manually stopped batch will not automatically restart. The START button or digital input must be used.

Automatic Overrun Correction

The ProtEX-MAX batch controller will correct for batch overrun or shortages automatically. By tracking the amount the batch was off by, the controller will automatically adjust the batch by modifying the batch relay deactivation time.

Single and Multi-Stage Batching

The ProtEX-MAX can be used as a single or multi-stage batch controller. Relays assigned to the total act as batch control relays, with additional relays beyond the first including a preclose value. The preclose deactivates the relay before the batch is finished, to allow slower fill rates and a more accurate batch finish. With expansion module relays, up to eight-stage batching is possible. Each additional stage batching relay has an individually programmable preclose amount.

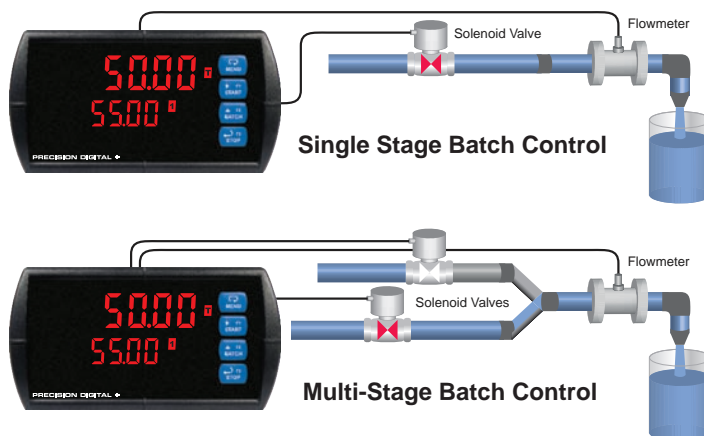

Quick Preset Changes

The front panel BATCH key is configured by default to access the preset menu. The preset may be changed quickly and easily between batches without the need to enter setup menus.

Non-Resettable Grand Total

The user can set up the grand total to be non-resettable by entering a specific password. Once this is done, the grand total can never be reset.

Total Conversion Factor

The user can enter a conversion factor that allows the controller to display total in different units than the rate. For instance, an operator could measure flow rate in gallons per minute and grand total in hundredths of acre-feet.

Grand Total & Rate Alarms

The ProtEX-MAX's four internal and four external relays can be set up to alarm when the grand total reaches a user-defined set point or when the rate is above or below a certain value. Rate alarms are only activated when the batching process is running. A variety of reset modes are available and the user can also program time delays and fail-safe operation.

On-Board Digital Input

The PD8-6210 and PD8-6310 include a digital input as standard. This digital input can operate with the tare, reset tare, or interlock relays feature, force relays on from a signal from a PLC or relay on other equipment, and much more. This is ideal for installations where the meter is inaccessible behind a cover, or where an additional function key is needed for customized operation.

Rounding

The rounding feature is used to give the user a steadier display with fluctuating signals. It causes the display to round to the nearest value according to the rounding value selected (1, 2, 5, 10, 20, 50, or 100). For example, with a rounding value of 10, and an input of 12346, the display would indicate 12350.

Four Types of Password Protection

The ProtEX-MAX offers 4 types of password protection. Level 1 protection allows the operator use of only the 3 pre-configured function keys on the front panel without a password. Level 2 protection allows the operator use of only the function keys and the ability to change set points without a password. Level 3 protection restricts the function keys and all configuration menus without a password. Grand total reset protection prevents the total from being reset manually.

Rugged

A unique front panel design makes the ProtEX-MAX nearly impenetrable in typical applications. Here, the ProtEX-MAX easily survives a direct hit on the display from a heavy 2" solid stainless steel ball dropped from eight feet.

INTEGRATED DIGITAL I/O AND SERIAL COMMUNICATIONS

Digital I/O Connections

Four digital inputs and four digital outputs come standard with the ProtEX-MAX. External digital inputs can function similarly to the front panel function keys or digital input F4. They can be configured to trigger certain events (i.e. acknowledge/reset alarms, reset max and/or min values, disable/enable all output relays, and hold current relay states), or provide a direct menu access point. The inputs can be used to configure the meter remotely using panel mount push buttons on a control station, giving the user remote control of the four front panel push buttons.

Digital outputs can be used to remotely monitor the ProtEX-MAX's alarm relay output states, or the states of a variety of actions and functions executed by the meter.

Note: The onboard digital inputs (1-4) are configured at the factory to function identically to the front panel pushbuttons (Menu, F1, F2, & F3) in order to work with the SafeTouch buttons. Changing the programming of the digital inputs will affect the function of the SafeTouch buttons.

Serial Communications Connections

ProtEX-MAX meters come with an RS-485 connection for serial communications with other digital devices. The industry standard Modbus® RTU protocol is included with every meter.

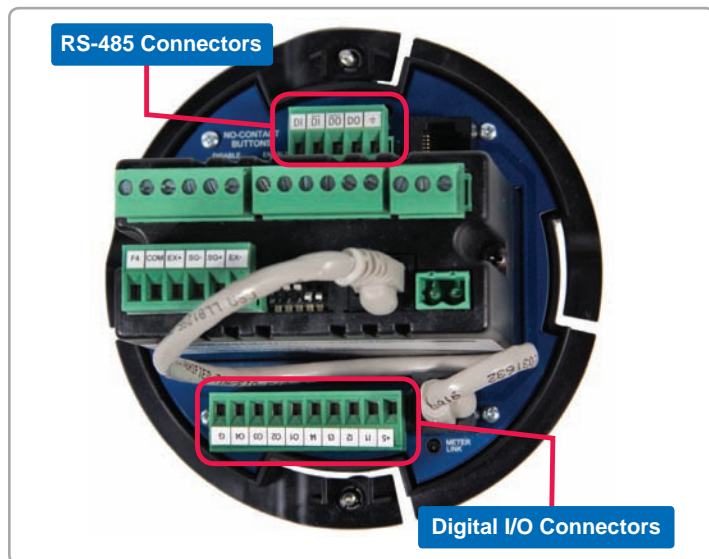

OUTPUTS

Relay Outputs

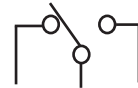

The ProtEX-MAX has up to four 3 A Form C relays (SPDT) with multiple programmable functions. One (relay 1) should always be used for batch control. Other relays may be configured as additional batch relays, with or without preclose for multi-stage batching or as alarms for the rate or grand total. Each alarm has multiple power loss fail-safe options. Alarm relays can be configured for proper protective action upon input loop break. Alarm relay ON and OFF delay times are user adjustable. Up to eight front panel indicators show alarm and/or relay state. All alarm relays can be configured for 0-100% deadband. Rate alarms are only active while a batch is running.

Relay Operation/Configuration

There are powerful relay functions that can be configured in the ProtEX-MAX controller, including:

- Single and multiple stage batch control with preclose
- Manual and automatic batch control modes
- Rate alarms during batch process
- Grand total alarms
- Sampling function
- User selectable fail-safe operation
- Relay action for loss (break) of 4-20 mA input signal (PD8-6210)
- Time delay (on and off), independent for each alarm relay

Analog Output

The isolated analog retransmission signal can be configured to represent the batch total, grand total, maximum (peak) value, minimum (valley) value, the value for any of the eight relay set points, manual setting control, or Modbus input. While the output is nominally 4-20 mA, the signal will accurately accommodate under- and over-ranges from 1 to 23 mA.

Isolated Transmitter Power Supplies

A powerful 24 V @ 200 mA power supply is a standard feature on the ProtEX-MAX controller. It can be configured for 5, 10, or 24 V (default) by means of a simple internal jumper (see manual). An additional power supply (24 V @ 40 mA) is standard with the 4-20 mA output option.

DIGITAL COMMUNICATIONS

Modbus® RTU Serial Communications

With the purchase of a serial communication adapter, ProtEX-MAX controllers can communicate with any Modbus Master device using the ever-popular Modbus communications protocol that is included in every ProtEX-MAX. Below are some examples of other things that can be done with ProtEX-MAX's Modbus communications.

- Start, pause, stop, or change preset values
- Send a 6-character message to the lower display upon an event
- Remote user control (i.e. change set points, acknowledge alarms)
- Read rate, total, grand total, batch count, etc.



Modbus PV Input



Remote Message

MANUAL MULTI-STAGE BATCH CONTROL OPERATION

System Setup

Both valves are closed with an empty barrel in place. The batched total is displayed in the upper display, the preset is selected for the lower display.

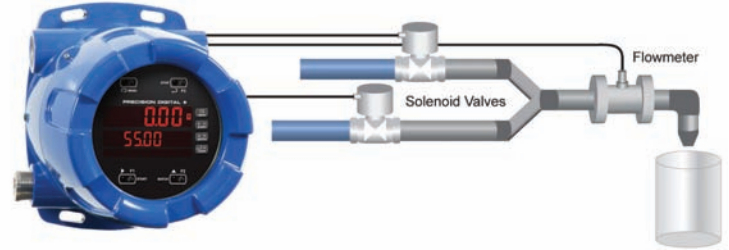

Batch Start

The START button is pressed. Both valves open. The barrel begins to fill.

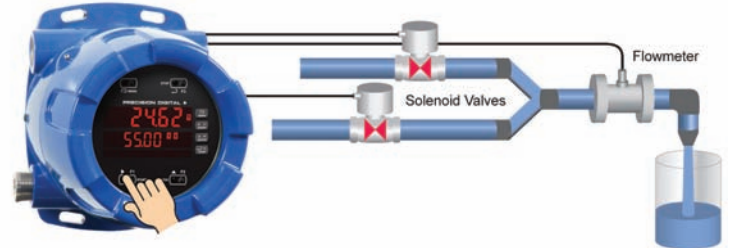

Preclose Valve

When the batch total reaches a value of 50.00 (Preset [55.00] – Preclose [5.00]) the full-flow valve closes. The fill rate of the tank slows as a result.

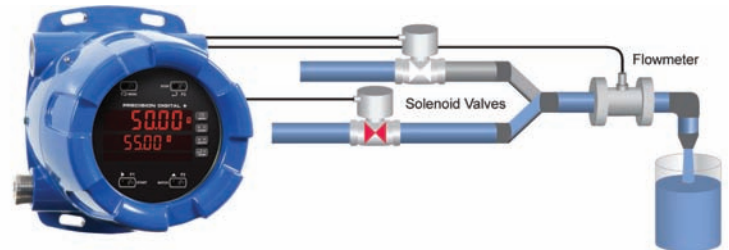

Completed Batch

When the batch total equals the preset amount, the restricted-flow valve closes. The barrel is now full. If some overrun occurs, the next batch will adjust for this offset amount to maintain accuracy.

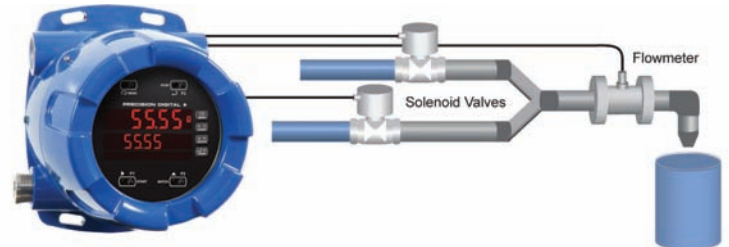

Change Preset

After placing a new, empty barrel, a new preset fill amount may be selected with the Batch key, while the process is stopped.

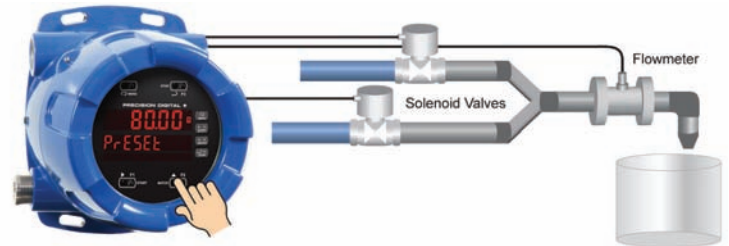

Begin New Batch

Press the START key and a new batch will begin. With both valves open, the process continues.

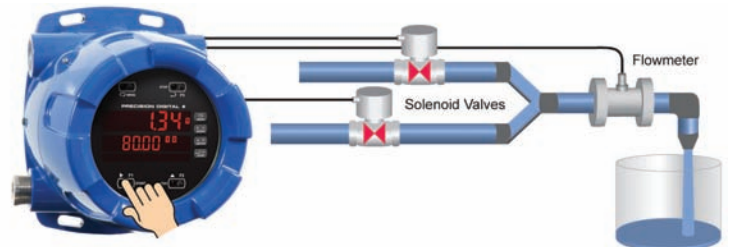

Pause/Stop

At any time, the STOP button may be pressed, once to Pause the process, or twice to cancel the batch, which stops the process.

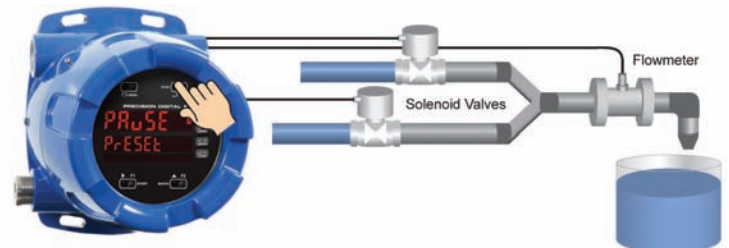

PD8-6210 / PD8-6310 ProtEX-MAX™ Batch Controllers

CONNECTIONS

PD8-6210

- Form C (SPDT) relays
- Two isolated supplies available even on 12/24 VDC input power models
- Removable terminal blocks
- 2 or 4 relays + isolated 4-20 mA output option

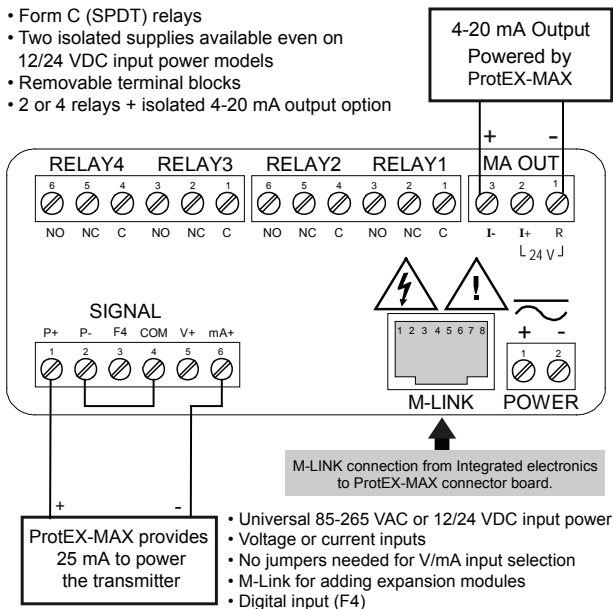

PD8-6310

- Form C (SPDT) relays
- Two isolated power supplies available even on 12/24 VDC input power models
- Removable terminal blocks
- 2 or 4 relays + isolated 4-20 mA output option

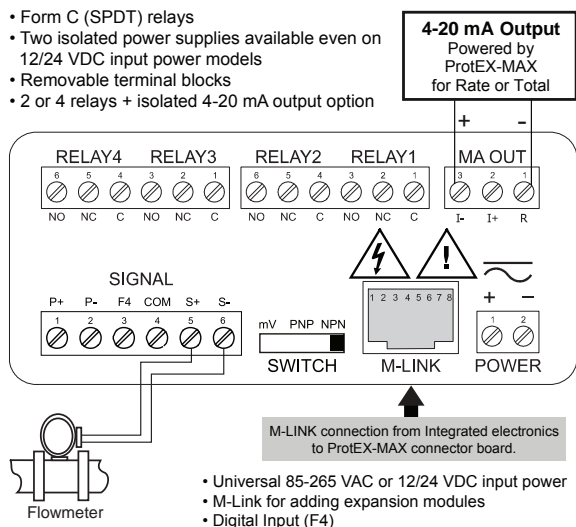

METERVIEW® PRO SOFTWARE

Configure, monitor, and datalog a ProtEX-MAX PD8-6210 or PD8-6310 from a PC using MeterView Pro Software (available via USB or for download at www.predig.com).

Batch Control From a Computer

Through MeterView Pro Software, the preset and relay 2 preclose may be easily changed from the main control window shown above. The total and grand total may be reset with just the click of a button. The batch controller may be started, paused, and stopped through the control window, for full featured batch controller operation.

Fully Program the Controller

All the programming parameters of the controller may be configured from MeterView Pro Software. The configuration file may be saved for later use, and saved configuration files may be loaded into the software for download into the ProtEX-MAX.

DIMENSIONS

Units: Inches (mm)

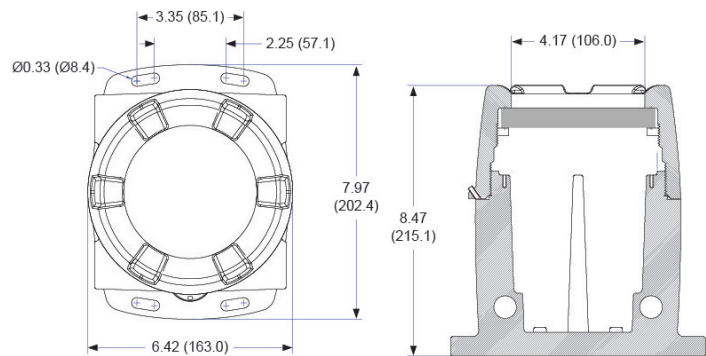

SPECIFICATIONS

Except where noted all specifications apply to operation at +25°C.

General

Display: Upper display: 0.60" (15 mm) high. Lower display: 0.46" (12 mm) high. Both are 6 digits (-99999 to 999999), red LEDs.

Default Display Assignment: The upper display shows batch total. The lower display shows rate with alternating units, and can be switched to show grand total, batch count, or preset with the STOP key.

Custom Display Assignment: The upper and lower displays may be assigned to rate, total, grand total, batch count, preset, set points, units (lower display only), alternating R & T, R & GT, preset & rate, max & min, or a Modbus display register. Any rate/total/grand total display may be programmed to alternate with a custom unit or tag.

Alternating Display: Displays alternate every 10 seconds when display is selected or the batch is paused.

Display Intensity: Eight user selectable intensity levels

Display Update Rate: 5/second (200 ms)

Overrange: Display flashes 999999

Underrange: Display flashes -99999

Front Panel: NEMA 4X, IP65

Operating Methods: Three programmable front panel buttons (default START, BATCH, STOP), digital inputs, PC and MeterView Pro software, and Modbus registers.

Programming Methods: Four SafeTouch through-glass buttons when cover is installed. Four internal pushbuttons when cover is removed.

F4 Digital Input Contacts: 3.3 VDC on contact. Connect normally open contacts across F4 to COM.

F4 Digital Input Logic Levels: Logic High: 3 to 5 VDC
Logic Low: 0 to 1.25 VDC

Noise Filter: Programmable from 2 to 199 (0 will disable filter)

Filter Bypass: Programmable from 0.1 to 99.9% of calibrated span.

Recalibration: Recommended at least every 12 months.

Max/Min Display: Max (Peak) / min (Valley) readings reached by the process are stored until reset by the user or until power is cycled.

Password: Three programmable passwords restrict modification of programmed settings and two prevent resetting the totals.

Non-Volatile Memory: All programmed settings are stored in non-volatile memory for a minimum of ten years if power is lost.

Power Options: 85-265 VAC 50/60 Hz, 90-265 VDC, 20 W max, or optional model with 12-24 VDC ±10%, 15 W max.

Fuse: Required external fuse: UL Recognized, 5 A max, slow blow; up to 6 controllers may share one 5 A fuse.

Isolated Transmitter Power Supply: Terminals P+ & P-: 24 VDC ± 10%. Internally selectable jumper for 24, 10, or 5 VDC supply.

All models transmitter supply rated @ 25mA max.

Normal Rejection Mode: Greater than 60 dB at 50/60 Hz (PD8-6210)

Isolation: 4 kV input/output-to-power line. 500 V input-to-output or output-to-P+ supply.

Overvoltage Category: Installation Overvoltage Category II: Local level with smaller transient overvoltages than Installation Overvoltage Category III.

Environmental: T6 Class operating temperature range Ta = -40 to 60°C

T5 Class operating temperature range Ta = -40 to 65°C

PD8-6210 / PD8-6310 ProtEX-MAX™ Batch Controllers

Max Power Dissipation: Maximum power dissipation limited to 15.1 W. See PD8-6210/6310 instruction manual for additional details.

Connections: Removable screw terminal blocks accept 12 to 22 AWG wire, RJ45 for external relays, digital I/O, and serial communication adapters.

Enclosure: Explosion-proof die cast aluminum with glass window, corrosion resistant epoxy coating, color: blue. NEMA 4X, 7, & 9, IP68. Default conduit connections: Four ¾" NPT threaded conduit openings and two ¾" NPT metal conduit plugs with 12 mm hex key fitting installed. Additional conduit opening configurations may be available; verify quantity and sizes on specific device labeling during installation.

Mounting: Four slotted flanges for wall mounting or NPS 1½" to 2½" or DN 40 to 65 mm pipe mounting

Weight: 16.0 lbs (7.26 kg)

Dimensions: 6.42" x 7.97" x 8.47" (W x H x D) (163 mm x 202 mm x 215 mm)

Warranty: 3 years parts & labor

USB Connection: Compatibility: USB 2.0 Standard, Compliant Connector Type: Micro-B receptacle

Cable: USB A Male to Micro-B Cable

Driver: Windows 98/SE, ME, 2000, Server 2003/2008, XP 32/64-Bit, Vista 32/64-Bit, Windows 7 32/64-Bit, Windows 10 32/64-Bit

Power: USB Port

PD8-6210 Analog Input

Inputs: Field selectable: 0-20, 4-20 mA, ±10 VDC (0-5, 1-5, 0-10 V), Modbus PV (Slave)

Accuracy: ±0.03% of calibrated span ±1 count, square root & programmable exponent accuracy range: 10-100% of calibrated span

Temperature Drift: 0.005% of calibrated span/°C max from 0 to 65°C ambient, 0.01% of calibrated span/°C max from -40 to 0°C ambient

Signal Input Conditioning: Linear, square root, programmable exponent, or round horizontal tank volume calculation.

Multi-Point Linearization: 2 to 32 points

Programmable Exponent: 1.0001 to 2.9999

Low-Flow Cutoff: 0-999999 (0 disables cutoff function)

Decimal Point: Up to five decimal places or none: dddddd, dddddd, dddddd, dddddd, or dddddd.

Calibration Range:

Input Range	Minimum Span Input 1 & 2
4-20 mA	0.15 mA
±10 V	0.10 V

An error message will appear if input 1 and input 2 signals are too close together.

Input Impedance: Voltage ranges: greater than 1 MΩ.

Current ranges: 50 - 100 Ω (depending on resettable fuse impedance).

Input Overload: Current input protected by resettable fuse, 30 VDC max. Fuse resets automatically after fault is removed.

PD8-6310 Pulse Input

Inputs: Field selectable: Pulse or square wave 0-5 V, 0-12 V, or 0-24 V @ 30 kHz; TTL; open collector 4.7 kΩ pull-up to 5 V @ 30 kHz; NPN or PNP transistor, switch contact 4.7 kΩ pull-up to 5 V @ 40 Hz; coil (sine wave) 40 mVp-p min @ 10 kHz; Modbus PV (Slave)

Low Voltage Mag Pickup (Isolated): Sensitivity: 40 mVp-p to 8 Vp-p

Minimum Input Frequency: 0.001 Hz - Minimum frequency is dependent on high gate setting.

Maximum Input Frequency: 30,000 Hz (10,000 for Low Voltage Mag Pickup)

Input Impedance: Pulse input: Greater than 300 kΩ @ 1 kHz. Open collector/switch input: 4.7 kΩ pull-up to 5 V.

Accuracy: ±0.03% of calibrated span ±1 count

Display Update Rate: Total: 10/sec, Rate: 10/sec to 1/1000 sec

Temperature Drift: Rate display is not affected by changes in temperature.

Multi-Point Linearization: 2 to 32 points

Low-Flow Cutoff: 0-999999 (0 disables cutoff function)

Decimal Point: Up to five decimal places or none: dddddd, dddddd, dddddd, dddddd, or dddddd.

Calibration: May be calibrated using K-factor, scale using internal calibration, or calibrate by applying an external calibration signal.

K-Factor: Field programmable K-factor converts input pulses to rate in engineering units. May be programmed from 0.00001 to 999,999 pulses/unit.

Calibration Range: Input 1 signal may be set anywhere in the range of the controller; input 2 signal may be set anywhere above setting.

Filter: Programmable contact de-bounce filter, 40 to 999 Hz maximum input frequency allowed with low speed filter.

Time Base: Second, minute, hour, or day

Low Gate: 0.1-99.9 seconds; this function determines how often the incoming pulses are calculated and the rate display is updated.

High Gate: 2.0-999.9 seconds; this function determines how long to wait for pulses before the display goes to zero. This function is used to display slow pulse rates.

Note: The combination of the low and high gate functions makes it possible to have a fast display update for fast pulse rates while displaying slow pulse rates, if needed. For example: If the low gate is set to 1.0 second and the high gate to 999.9 second, with a fast pulse rate the display is updated every second; with a slow pulse rate the controller is capable of waiting up to 999.9 seconds before calculating the rate, making it possible to display a very slow rate down to 1 pulse/999.9 second (0.001 pulse/second).

Batch Controller

Rate Display Indication: 0 to 999999, lead zero blanking. "R" LED illuminates while displaying rate.

Total Displays & Grand Total Overflow: 0 to 999,999; automatic lead zero blanking. "T" LED is illuminated while displaying batch total and "GT" for grand total. Up to 999,999,999 with total-overflow feature. "oF" is displayed to the left of grand total overflow and ▲ LED is illuminated.

Batch Total Decimal Point: Up to five decimal places or none: dddddd, dddddd, dddddd, dddddd, or dddddd.
Total decimal point is independent of rate decimal point.

Totalizer: Calculates total based on rate and field programmable multiplier to display total in engineering units. Time base must be selected according to the time units in which the rate is displayed.

Total Conversion Factor: 0.00001 to 999,999

Batch Preset: 0.00001 to 999,999 based on batch total decimal point.

Automatic Batch Restart Delay: 00000.1 to 999.9 seconds. The batch will automatically restart after completion of the last batch.

Grand Total Rollover: Totalizer rolls over when display exceeds 999,999,999. Relay status reflects the display value.

Grand Total Alarms: Up to seven, user selectable under Setup menu. Any set point can be assigned to grand total and may be programmed anywhere in the range of the controller for grand total alarm indication. Note that Relay 1 should always be assigned to batch control (Total).
Grand Total Reset: Via front panel button, external contact closure on digital inputs, automatically via user selectable preset value and time delay, or through serial communications.

Grand Total Reset Password: A grand total password may be entered to prevent resetting the grand total from the front panel.

Non-Resettable Grand Total: The grand total can be programmed as a non-resettable total by entering the password "050873".
Caution: Once the Grand Total has been programmed as "non-resettable" the feature cannot be disabled

Relays

Rating: 2 or 4 SPDT (Form C) internal and/or 4 SPST (Form A) external; rated 3 A @ 30 VDC and 125/250 VAC resistive load; 1/14 HP (≈ 50 W) @ 125/250 VAC for inductive loads

Noise Suppression: Noise suppression is recommended for each relay contact switching inductive loads.

Relay Assignment: Relays may be assigned to batch control, sampling, rate, or grand total alarms.

Preclose: 0-100% of batch size, individually user programmable for each additional batch control relay beyond the first.

Alarm Deadband: 0-100% of span, user programmable

High or Low Alarm: User may program any alarm for high or low trip point. Unused alarm LEDs and relays may be disabled (turned off).

Batching Relay Operation: Single or (2 to 8) multi-relay batching with optional preclose for multi-stage operation. Each additional relay may be programmed with an individual preclose value.

Alarm Relay Operation: Automatic (non-latching), latching (requires manual acknowledge), sampling (based on rate or grand total), pump alternation control (2 to 8 relays), off (disable unused relays), and manual on/off control mode. Alarms are active only when the batch is running.

Alarm Relay Reset: User selectable via front buttons, digital inputs, or PC
1. Automatic reset only (non-latching), when input passes the reset point or total is reset to zero.

PD8-6210 / PD8-6310 ProtEX-MAX™ Batch Controllers

- Manual reset only, when batch is stopped (latching).
 - Manual reset only after alarm condition has cleared (latching)
- Note: Front panel button or digital input may be assigned to acknowledge relays programmed for manual reset. This replaces one of the standard batch control function keys. Only the PAUSE/STOP key function is possible during a batch process, so manual reset may only be done when the controller is in STOP mode.*

Deadband: 0-100% of span, user programmable
Time Delay: 0 to 999.9 seconds, on & off relay time delays. Programmable and independent for each relay.
Fail-Safe Operation: Programmable and independent for each relay.
Note: Relay coil is energized in non-alarm condition. In case of power failure, relay will go to alarm state.
Auto Initialization: When power is applied, relays will reflect the state of the input. Alarms are active only when the batch is running.

Isolated 4-20 mA Transmitter Output

Output Source: Rate/process, total, grand total, max, min, set points 1-8, manual control setting, or Modbus input
Scaling Range: 1.000 to 23.000 mA for any display range
Calibration: Factory calibrated: 4.000 to 20.000 = 4-20 mA output
Analog Output Programming: 23.000 mA maximum for all parameters: Overrange, under-range, max, min, and break
Accuracy: ± 0.1% FS ± 0.004 mA
Temperature Drift: 0.4 µA/°C max from 0 to 65°C ambient, 0.8 µA/°C max from -40 to 0°C ambient
Note: Analog output drift is separate from input drift.
Isolated Transmitter Power Supply: Terminals I+ & R: 24 VDC ± 10%. Isolated from the input at >500 V. May be used to power the 4-20 mA output or other devices. All models @ 25 mA max.
External Loop Power Supply: 35 VDC maximum
Output Loop Resistance:

Power supply	Minimum	Maximum
24 VDC	10 Ω	700 Ω
35 VDC (external)	100 Ω	1200 Ω

Product Ratings and Approvals

FM: Type 4X; IP66
 Class I, Division 1, Groups B, C, D
 Class II, Division 1, Groups E, F, G
 Class III, Division 1, T5/T6
 Class I, Zone 1, AEx d, IIC Gb T5/T6
 Zone 21, AEx tb IIIC T90°C; Ta -40°C to +65°C
 T6 Ta = -40°C to +60°C; T5 Ta = -40°C to +65°C
 Certificate Number: 3047283

CSA: Class I, Division 1, Groups B, C, D
 Class II, Division 1, Groups E, F, G
 Class III, Division 1
 Class I Zone 1 Ex d IIC
 Zone 21 Ex tb IIIC T90°C
 -40°C < Tamb. < +60°C; Temperature Code T6
 -40°C < Tamb. < +65°C; Temperature Code T5
 Enclosure Type 4X & IP66
 Certificate Number: 2531731

ATEX: II 2 G D
 Ex d IIC T* Gb
 Ex tb IIIC T90°C Db IP68
 Ta = -40°C to +*°C
 *T6 = -40°C to +60°C
 *T5 = -40°C to +65°C
 Certificate number: Sira 12ATEX1182

IECEx: Ex d IIC T* Gb
 Ex tb IIIC T90°C Db IP68
 Ta = -40°C to +*°C
 *T6 = -40°C to +60°C
 *T5 = -40°C to +65°C
 Certificate Number: IECEx SIR 12.0073

Serial Communications

Protocol: Modbus® RTU
Controller Address/Slave ID: 1 - 247
Baud Rate: 300 - 19,200 bps
Transmit Time Delay: Programmable between 0 and 199 ms or transmitter always on for RS-422 communication
Data: 8 bit (1 start bit, 1 or 2 stop bits)
Parity: Even, odd, or none with 1 or 2 stop bits
Byte-to-Byte Timeout: 0.01 - 2.54 seconds
Turn Around Delay: Less than 2 ms (fixed)
Note: Refer to the ProVu® Modbus Register Tables located at www.predig.com for details.

ORDERING INFORMATION

ProtEX-MAX® PD8-6210 Analog Input		
85-265 VAC Model	12-24 VDC Model	Options Installed
PD8-6210-6H2	PD8-6210-7H2	2 Relays
PD8-6210-6H4	PD8-6210-7H4	4 Relays
PD8-6210-6H5	PD8-6210-7H5	2 Relays & 4-20 mA Output
PD8-6210-6H7	PD8-6210-7H7	4 Relays & 4-20 mA Output

Note: 24 V flowmeter power supply standard on all models.

ProtEX-MAX® PD8-6310 Pulse Input		
85-265 VAC Model	12-24 VDC Model	Options Installed
PD8-6310-6H2	PD8-6310-7H2	2 Relays
PD8-6310-6H4	PD8-6310-7H4	4 Relays
PD8-6310-6H5	PD8-6310-7H5	2 Relays & 4-20 mA Output
PD8-6310-6H7	PD8-6310-7H7	4 Relays & 4-20 mA Output

Note: 24 V flowmeter power supply standard on all models.

Accessories	
Model	Description
PDAPLUG75	3/4" NPT 316 Stainless Steel Stopping Plug with Approvals
PDA7485-I	RS-232 to RS-422/485 Isolated Converter
PDA7485-N	RS-232 to RS-422/485 Non-Isolated Converter
PDA8485-I	USB to RS-422/485 Isolated Converter
PDA8485-N	USB to RS-422/485 Non-Isolated Converter
PDA6846	Pipe Mounting Kit Zinc Plated (Requires 2)
PDA6846-SS	Pipe Mounting Kit Stainless Steel (Requires 2)

Your Local Distributor is:

Disclaimer

The information contained in this document is subject to change without notice. Precision Digital Corporation makes no representations or warranties with respect to the contents hereof, and specifically disclaims any implied warranties of merchantability or fitness for a particular purpose. ©2016 Precision Digital Corporation. All rights reserved.

LDS8-6210_A 05/16